

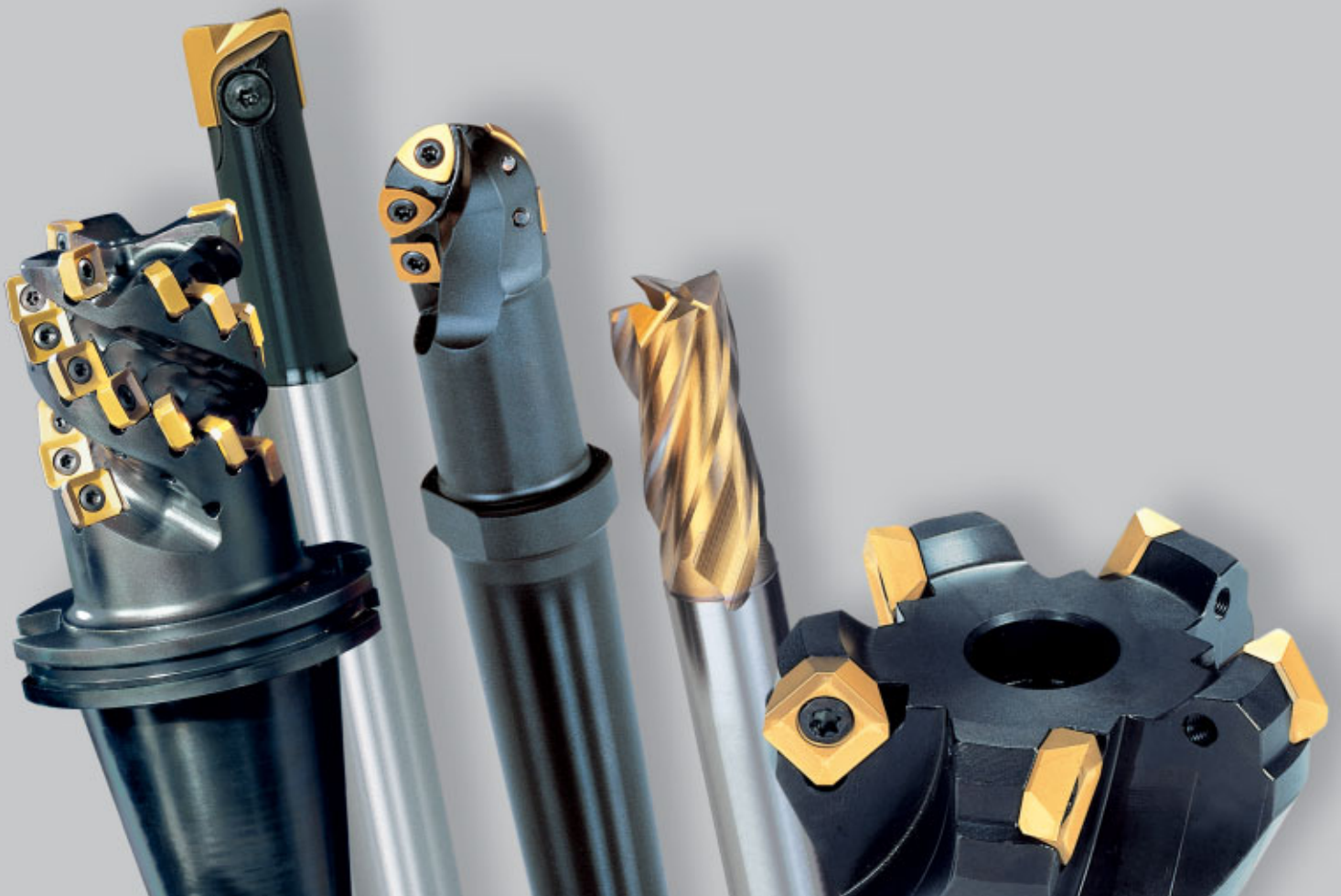

Fräsen

Milling



Leitz Metalworking Technology Group
BELIN • BILZ • BOEHLERIT •
FETTE • KIENINGER • ONSRUD

BOEHLERIT

FETTE
FETTE

BELIN

LMT.

BILZ

BILZ

ONSRUD

Onsrud
Cutter

KIENINGER

W
K

6 zu Ihrem Vorteil 6 for your advantage

Sechs Unternehmen mit 3.000 Mitarbeitern bilden die Leitz Metalworking Technology Group (LMT). Jedes Unternehmen entwickelt und fertigt Präzisionswerkzeuge für bestimmte Segmente der Metall- und Kunststoffbearbeitung. Jedes Unternehmen ist mit seiner Erfahrung und seinen Erzeugnissen in seinem speziellen Arbeitsgebiet erfolgreich und technologieführend. Zusammen bietet das Leistungspotenzial der LMT nahezu lückenlos vorteilhafte Lösungen für sämtliche Zerspanungsoperationen.

Im Zeichen von Globalisierung und steigendem Wettbewerb werden neue Wege der Rationalisierung notwendig. Der Automobilbau, die Luft- und Raumfahrttechnik, Maschinen- und Anlagenhersteller suchen neue Lösungen wirtschaftlicher Zusammenarbeit. Leistungsstärke braucht starke Partnerschaft! Als Partner der produzierenden Industrie und ihrer führenden Unternehmen tragen die Firmen der LMT dieser Entwicklung Rechnung. Deshalb haben sie ihre Ressourcen, ihre Entwicklungs- und Versuchspotenziale gebündelt.

Anwendungsberatung und Vertrieb sind für die Bundesrepublik Deutschland in der LMT Deutschland GmbH zusammengefasst. Das gesamte Dienstleistungs- und Produktspektrum der LMT-Gruppe kommt nunmehr aus einer Hand. Kompetente Außendienstmitarbeiter beraten Sie in allen Fragen des vielseitigen Katalogangebotes. Bei besonderen Aufgabenstellungen aus der täglichen Praxis, etwa komplexen Tool-Management-Lösungen, stehen Ihnen die Fachingenieure der LMT gerne mit Rat und Tat zur Seite.

Wählen Sie einfach +49 (0) 800-LMT tools (+49 (0) 800-56 88 665) und Sie erhalten direkten Kontakt.

Six companies with more than 3,000 employees: this is the Leitz Metalworking Technology Group (LMT). Each company develops and produces precision tools for specific segments of the metalworking and plastics processing industries. With its experience and its products, each company is a successful technological leader in its specific working area. Together, LMT's collective performance potential offers benefits in just about every area of machining and chip-removal processing.

Globalisation is the order of the day, with increasingly severe competition making new rationalisation methods essential. The automotive industries, aerospace, machine tool and equipment manufacturers are all searching for new methods of economically viable cooperation. For effective performance, they need competent partners! The companies in the LMT group have already demonstrated to many leading companies in the manufacturing industries that they can satisfy this requirement: they have the resources and the concentrated development and experimental facilities that are needed for success.

For the Federal Republic of Germany, application consultancy and sales are undertaken by LMT Deutschland GmbH, so that the entire range of LMT services and products can be obtained from a single source. Experienced field service staff advise and assist clients on this wide-ranging program. If specific questions have to be solved, for instance those concerning complex tool management, expert engineers from LMT Deutschland GmbH are always available to suggest an answer.

Just dial +49 (0) 800-LMT tools (+49 (0) 800-56 88 665) to make contact directly.



6 Unternehmen und ihr Selbstverständnis 6 companies and what they can offer

Die sechs Unternehmen der LMT sind eigenständige Gesellschaften. Ihre Kompetenz und Akzeptanz als produzierende Dienstleister und Partner weltweit operierender High-Tech-Hersteller verdanken sie der innovativen Realisierung höchster Präzisions- und Qualitätsansprüche. Sie verfügen über ein praxisorientiertes Erfahrungspotenzial, das im internationalen Vergleich einmalig ist. Mit eigens entwickelten Präzisionswerkzeugen haben LMT-Unternehmen beispielsweise seit Beginn der industriellen Automobil- und Flugzeugproduktion Anteil am technischen Fortschritt. Die Flexibilität unserer mittelständischen Unternehmensgröße sichert Ihnen schnelle, maßgeschneiderte Problemlösungen – und damit wirtschaftliche Vorteile.

Die Eigenständigkeit jedes Unternehmens bleibt nach wie vor Besonderheit der LMT. Bei der Vielzahl individueller Aufgabenstellungen, sei es im Engineering, der Projektierung, Entwicklung, Inbetriebnahme oder Wiederaufbereitung bestimmter Werkzeuge, besteht für Sie jederzeit direkter Zugriff auf die spezielle Fachkompetenz jedes einzelnen LMT-Unternehmens. Wo jedoch das Zusammenwirken der sechs Spezialisten für die komplexe Bearbeitung ganzer Baugruppen sinnvoller ist, bietet Ihnen die LMT Deutschland GmbH gesamtverantwortliches Tool-Process-Handling.

Mit diesem Selbstverständnis und der Anpassungsfähigkeit an global unterschiedliche Marktgegebenheiten und Kundenwünsche unterscheidet sich die LMT von anderen Werkzeuganbietern – zu Ihrem Nutzen.

Within LMT, the six companies operate autonomously. They owe their recognised competence as service providers with own manufacturing facilities and as partners of high-tech manufacturers all over the world to the innovative methods with which they satisfy the very highest precision and quality demands. They can call upon an internationally unique depth of practically-oriented experience. With precision tooling solutions, for instance, LMT companies have contributed to technical progress ever since industrial-scale automobile and aircraft production commenced. Thanks to the flexibility of the LMT companies, it is possible to provide your tailor-made answers to processing problems with no delay – and therefore maximise your economic advantages.

Each company remains fully autonomous – this is part of LMT success story. Tasks can be tackled individually in the engineering area or in the project management, research and development or reconditioning of specific tools. In every case there is direct access to the unrivalled skills of the relevant LMT company. And whenever there is an obvious benefit from combining the know-how of these six specialist sources, for instance in the complex processing of complete work pieces or for all kind of tool management tasks, LMT Deutschland GmbH steps in and offers to take the responsibility for your tool-process handling.

This approach, combined with the ability to adapt globally to all differences in market conditions and clients' wishes, is helping to set LMT apart from other tool suppliers – and to assure to you a maximum benefit.

BELIN

BILZ

BOEHLERIT

FETTE

KIENINGER

ONSRUD

6 Spezialisten und ihre Stärken

6 specialists and their strengths

BELIN

Belin, Frankreich, ist ein Technologieführer für Hochleistungs-Reibahlen aus Hartmetall, PKD und CBN sowie für hochgenaue Nutenfräser und Vollhartmetall-Schaftfräser für Kunststoffe und Aluminiumlegierungen.

Belin (France) is a technological leader for high-performance carbide metal reamers, PKD and CBN and high-precision grooving mills and all-carbide end milling cutters for plastics and aluminium alloys.

BILZ

Bilz, Deutschland, ist auf dem Gebiet der Werkzeugspanntechnik tätig und heute der führende Hersteller von Gewindeschneidfuttern und des Thermo-Grip®-Systems für das thermische Spannen von rotierenden Werkzeugen.

Bilz (Germany) operates in the field of tool clamping and is now the leading manufacturer of thread-tapping chucks and also of the Thermo-Grip® system for the thermal clamping of revolving tools.

BOEHLERIT

Boehlerit, Österreich, steht als Hersteller von Schneidstoffen für die Metall-, Verbundwerkstoff-, Kunststoff- und Holzbearbeitung sowie von Hartmetallen für nicht spanende Anwendungen weltweit für höchste Fertigungsperfektion von Hartmetallen und Werkzeugen zum Drehen, Fräsen, Bohren und Drehschälen sowie für die spanlose Formgebung.

Boehlerit (Austria), a manufacturer of cutting materials for metal, composites, plastics and wood and of carbide metals for non-cutting applications, has a high worldwide reputation for ultimate precision in the processing of carbide metals and tools for lathe turning, milling, drilling and rotary peeling, and also for chipless forming.

FETTE

Fette, Deutschland, nimmt als Hersteller von Präzisions-Fräswerkzeugen und Wälzfräsern mit einem breiten Programm aus Hartmetall und Schnellstahl für die Metall- und Kunststoffbearbeitung sowie für Gewinderollsysteme und Gewindebohrer eine herausragende Stellung ein.

Fette (Germany) has earned an outstanding position as a manufacturer of precision milling and hobbing tools and supplies an extensive programme of carbide-metal and high-speed steel tools for metal and plastics processing and for thread rolling systems and thread tapping dies.

KIENINGER

Kieninger, Deutschland, ist auf dem Gebiet der Sonderzerspannsysteme für komplexe Bohrungsbearbeitung und der Präzisionsbearbeitung im Gesenk- und Formenbau sowie für den Werkzeug- und Modellbau in weltweit anerkannter Spitzenstellung.

Kieninger (Germany) occupies a leading position on the market for special cutting systems used for more complex bore machining and precision machining work within the dies and moulds industries and for the machining of engine components for the automotive industry.

ONSRUD

Onsrud, USA, ist spezialisiert auf die Herstellung von Schaftfräsern für die Hochgeschwindigkeitsbearbeitung von Aluminium, Kunststoffen und Verbundwerkstoffen in der Luft- und Raumfahrtindustrie.

Onsrud (USA) specialises in the production of end-milling cutters for high-speed machining of aluminium, plastics and composite materials in the aerospace industries.



Kompetenzen und Referenzen der LMT

LMT's competences and references

Das Produktangebot der sechs LMT-Unternehmen umfasst mehr als 30.000 Werkzeuge aus eigener Entwicklung und Herstellung. Hinter dieser Vielfalt steht ein außerordentliches Wissens- und Erfahrungspotenzial. Seit der ersten Stunde maschineller Metallbearbeitung sind Unternehmen der LMT an der Entwicklung effizienter Maschinen-Werkzeuge, an ihrer Weiterentwicklung und Ausrichtung auf neue Werkstoffe, immer neue Spitzenleistungen in Präzision, Qualität, Zeit- und Kostenersparnis maßgeblich beteiligt.

Die LMT-Unternehmen bieten Werkzeugsysteme und Zubehör für die gesamte Bandbreite moderner Zerspantechnik. Sie können ihren Kunden deshalb eine objektiv systemneutrale Beratung und Empfehlung garantieren, welche Bearbeitungsabläufe sich mit welchen Verfahren und welcher Werkzeugbestückung am besten und wirtschaftlichsten lösen lassen. Dazu beherrscht die LMT alle Schneidstoffe und zugleich auch die modernsten Beschichtungsverfahren. Mehr und mehr Kunden nehmen diese Beratungskompetenz für sich in Anspruch – mit eindeutig überzeugenden Vorteilen. Wenn sich innerhalb der breiten Palette an Standardwerkzeugen keine Lösung für Ihren Anwendungsfall finden lässt, dann geht die LMT zusammen mit Ihnen den Weg, durch Entwicklungen und Versuche das für Sie optimale Sonderwerkzeug zu produzieren.

Gerne zeigen wir Ihnen unsere Leistungsstärke anhand ausführlicher Referenzen aus der langjährigen Zusammenarbeit mit der Automobil- und Zulieferindustrie, dem Nutzfahrzeugbau, der Luft- und Raumfahrt, wie dem allgemeinen Maschinenbau. Auch die modernen Felder der Zerspantechnik in Medizin, Optik, Elektronik oder Windkraft sind maßgeblich durch Werkzeuge der LMT geprägt.

The product programme available from the six LMT companies comprises more than 30,000 tools, developed and manufactured by the companies themselves. This sheer variety is backed by exceptional knowledge and experience. Ever since machine metalworking methods first appeared, LMT companies have been closely involved in the design and ongoing development of efficient machine tools, including adapting them to process new materials and achieve constantly new peak performance levels in terms of precision, quality, speed and economy.

LMT companies supply tool systems and accessories for every area of modern cutting technology. This enables them to offer their clients objective advice and recommendations not restricted to specific systems and to make specific proposals for the most suitable processes and tools to be used for the best results and maximum economy. LMT has total mastery of all cutting materials and also of the latest coating processes. More and more clients make use of LMT's advisory skills – with convincing benefits all round. If it is not possible to find a solution for your task within the big range of standard tools, LMT makes its full development and experimental resources available to you so that the ideal special tool can be produced.

LMT companies will gladly supply detailed references from their long-standing cooperation with the automobile and component supply industries, manufacturers of rail, off-road and waterborne vehicles, aerospace and general machinery construction areas. Many of the most advanced cutting processes used in medicine, optics, electronics or wind-power generation have been greatly promoted by the use of LMT tools.



Wichtige Bestell- und Lieferhinweise	Important hints for ordering and delivery	10
Fräswerkzeuge mit Wendeplatten	Milling cutting tools with Indexable Inserts	15
Wendeplatten	Indexable Inserts	19
Einstellbares modulares Frässystem Multi-Mill	Multi-Mill Milling Cutter System	73
Einstellbare modulare Messerkopfsysteme 1D, 2D, 2D-Mini, 3D	Milling Cutter Systems 1D, 2D, 2D-Mini, 3D	97
Plan- und Eckfräsköpfe	Face Milling Cutters	121
Schaft- und Walzenstirnfräser	End and Shell End Mills	145
Kopierfräser für den Gesenk- und Formenbau	Copy Milling Cutters for mould and die industry	175
Scheibenfräser und Trennfräser	Side Milling Cutters	225
Zahnformfräser	Gear Milling Cutters	233
Werkzeuge mit polykristallinen Schneiden (PKD, CBN) (gelötet, WSP)	Tools with polycrystalline cutting edges (PCD, CBN) (braized)	247
Fräswerkzeuge aus Vollhartmetall, Cermet und mit gelöteten HM-Schneiden	Milling Cutting Tools Solid Carbide, Cermet, and with brazed tips	267
Fräser für allgemeine Bearbeitung	Milling Cutters for general machining	271
Gewindefräser, Fräser mit eingelöteten HM-Schneiden	Thread Milling Cutters, Cutters with brazed carbide tips	291
HSC-line und Fräser für den Gesenk- und Formenbau	HSC-line and Milling Cutters for mould and die industry	309
AIRline und Schaftfräser zur Aluminium- und Kunststoffbearbeitung	AIRline and End mills for aluminium and plastic machining	331
Fräswerkzeuge PM-Edition, HSS	Milling Cutting Tools, PM-Edition, HSS	361
PM-Edition Schaftfräser	PM-Edition-End Mills	363
Schaftfräser HSS-E	End Mills HSS-E	411
PM-Edition Walzenstirnfräser	PM-Edition Shell End Mills	469
Walzenstirnfräser HSS-E	Shell End Mills HSS-E	481
Scheibenfräser- und Kreissägeblätter	Side and Face Milling Cutters and Metal Slitting Saws	497
Formfräser HSS-E	Form Milling Cutters HSS-E	533
Anhang	Attachment	585

Wichtige Bestellhinweise

Important hints

Programmaktualität

Das LMT-Gesamtprogramm in verschiedenen Katalogen mit ca. 25.000 Standardartikeln unterliegt einer ständigen Programmpflege. Im Rahmen dieser kontinuierlichen Aktualisierung nehmen wir nicht nur neue und damit technisch bessere Produkte im Programm auf, sondern führen auch eine intensive Programmbereinigung durch. Es kann also im Einzelfall passieren, daß wir einen von Ihnen bestellten Artikel nicht mehr lagermäßig führen. Sie erhalten dann von uns in der Regel ein technologisch besseres Produkt, mindestens aber eine gleichwertige Alternative. In Zweifelsfällen werden sich unsere Verkaufsteams mit Ihnen in Verbindung setzen, um eine für Sie optimale Ausführung zu bestimmen. Dadurch ist sichergestellt, daß Sie stets mit Werkzeugen beliefert werden, die auf dem neuesten Stand der Technik sind. Eine Verpflichtung zur Lieferung von im Katalog abgebildeten Werkzeugen, die aber bereits ersetzt wurden, übernehmen wir nicht.

Artikelnummern

Um die Auftragsbearbeitung zu beschleunigen und Verwechslungen auszuschließen, bitten wir bei Aufträgen um Angabe der im Katalog genannten Artikelnummern und/oder der Artikelbezeichnung.

Preise

Dieser Katalog enthält keine Preise. Diese entnehmen Sie bitte der jeweils gültigen Preisliste.

Mindestauftragswert

Wir bitten um Verständnis, daß wir Aufträge bis zu einem Gesamtwert von € 100,- nur gegen eine zusätzliche Bearbeitungsgebühr in Höhe von € 30,- ausführen können.

Werkzeuggruppen

Unser breites Programm an Präzisionswerkzeugen ist nach Werkzeuggruppen geordnet, die über das Inhaltsverzeichnis auf Seite 9 und ein Register an der Seite des Kataloges kenntlich gemacht und dadurch leicht aufzufinden sind.

Werkzeugauswahl

Am Anfang jeder Werkzeuggruppe stehen Auswahlübersichten, die Ihnen ein schnelles Auffinden der Werkzeuge für Ihren Anwendungsfall ermöglichen.

Anwendungstechnische Hinweise

Ab Seite 585 finden Sie technische Hinweise von allgemeiner, übergeordneter Gültigkeit. Dagegen sind die speziellen technischen Hinweise zu den einzelnen Produktgruppen dem jeweiligen Abschnitt direkt zugeordnet.

Werkzeuge

Wenn nicht anders angegeben, sind die Werkzeuge rechtsschneidend bzw. für Rechtsgewinde.

Z = Zähnezahl

- = Anzahl der Schneiden
- = Anzahl der Spannuten
- = Anzahl der Zahnreihen

Sonderformen

Sollten Sie eines Ihrer Bearbeitungsprobleme nicht mit einem unserer ca. 25.000 lagergängigen Werkzeuge lösen können, bieten wir Ihnen Sonderformen oder zeichnungsgebundene Werkzeuge auf Anfrage an. Unsere Anwendungstechniker beraten Sie gern.

Programme updating

The LMT catalogue programme covers approx. 25.000 standard items this under constant review. Within the framework of a continuous bringing cleaning, we not only adapt new and therefore technologically better products into the programme, but we also engage in intensive programme clearing.

In some cases it could happen that we do not carry in stock the item which you have ordered. In that case you will in general receive a technologically better product which is at least an equivalent alternative. In case of doubt, our sales teams will contact you, in order to determine a design that will produce best possible results for you.

By this, it is sure that you are always supplied with tools, which are technologically on the newest level. For that reason, we do not feel obliged to supply tools, shown in the catalogue, which have been cleared or superceded from the programme profile.

Article numbers

To speed up order processing and to avoid confusions, orders should always specify the ident numbers and/or item designation listed in the catalogue.

Prices

For prices, please refer to the current price list.

Minimum order value

A handling fee of € 30,- is charged for orders up to a total value of € 100,-.

Tool groups

Our wide range of precision tools is subdivided into tool groups. These are identified by a content on page 9 and a survey index in the catalogue so that they can be located quickly.

Tool selection

A broad table of selection is shown in front of each tool section, this makes it possible for you to pick out requirements quickly which are suitable for your application.

Technical details

Technical application details commence on page 585, the technical details concerning individual product groups are directly assigned to the section concerned.

Tools

If not specified otherwise, tools are for right-hand or for a right-hand thread.

Z = Number of teeth

- = Number of cutting edges
- = Number of flutes
- = Number of tooth rows

Special designs

If you find that your specific machining problems cannot be resolved with any of our 25.000 permanently stocked tools, then we can supply special designs or tools made according to drawings. Our application technicians will be glad to help you.

Im weiteren Verlauf des Kataloges finden Sie bei Wendepplattenfräsern neben den alten Katalognummern die neuen „sprechenden“ Katalogbezeichnungen.
Dieses neue System beschreibt die Werkzeugtypen und -geometrien auf einfache Weise.

Further on the catalogue you will find that the former catalogue numbers for the indexable insert cutters have been supplemented by the new “talking” catalogue codes.
This new system describes the tool types and geometries in a simple fashion.

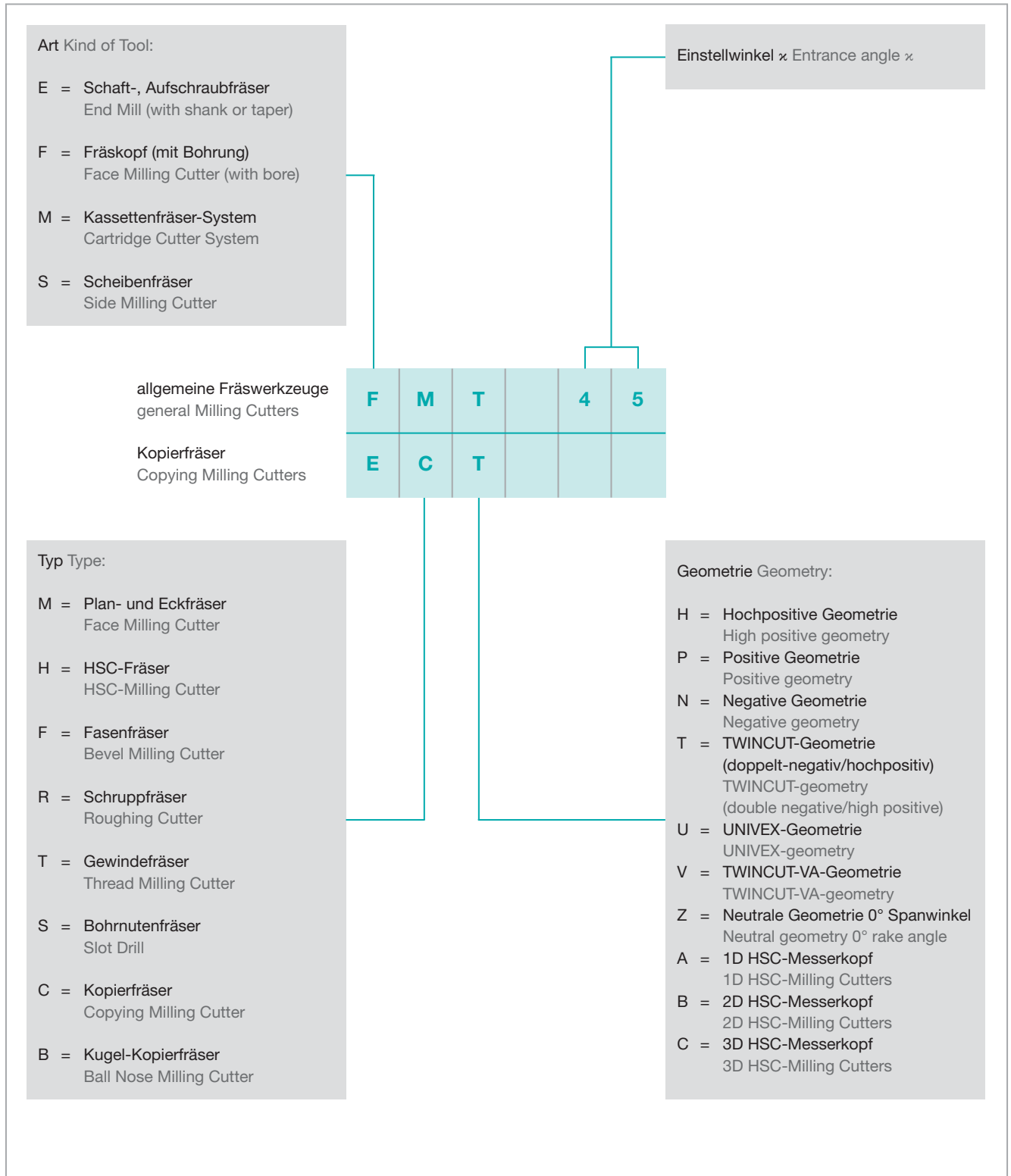

Das LMT-Anwendungsfarbsystem für Fräswerkzeuge

LMT application colour identification system for Milling Cutting Tools

... hilft Ihnen bei der Auswahl des optimalen Werkzeuges und des wirtschaftlichsten Schneidstoffes für Ihren Arbeitsfall
 ... hat Gültigkeit für Hartmetall- und Schnellstahlwerkzeuge
 ... erleichtert Ihnen die Bestimmung der optimalen Schnittwerte.

... does help you, when selecting the best suitable tool and the most economical cutting material for your application
 ... is usable with carbide- and high speed steel tooling
 ... makes it easier for you to determine the most suitable cutting values.

Sie finden den Farbschlüssel in den ...

... Bestelltabellen der Hartmetall-Wendeplatten
 ... Werkstoffvergleichstabellen
 ... Schnittwerttabellen.

You can find the colour key on the ...

... tables for ordering carbide indexable inserts
 ... material comparison tables
 ... tables for cutting values.

Und so hilft Ihnen der LMT-Farbschlüssel

Sie wollen beispielsweise den Werkstoff 1.7225 bearbeiten. In der Werkstofftabelle auf Seite 586 finden Sie 1.7225 im hellblauen Bereich.

Sie benötigen die optimale Wendeplatten-Sorte für Ihren Arbeitsfall.

In den Bestelltabellen finden Sie Farbmarkierungen, entsprechend der ISO-Klassifizierung. Darunter finden Sie die Bestellnummer der für Sie optimalen Wendeplatte: LC225S im blauen Bereich.

Sie benötigen die optimalen Schnittwertempfehlungen für das gewählte Werkzeug.

Am Ende eines jeden Registers finden Sie die jeweiligen Schnittwert-Tabellen.

Sie finden Ihren Werkstoff und unsere Empfehlung für die HM-Sorte und Schnittwerte im entsprechenden Farbbereich.

And this is the way, the LMT colour key helps you

You want e. g. to machine material 1.7225. On the material chart on page 586 you find 1.7225 in the light blue range.

You need the most suitable indexable insert grade for your job application.

On the ordering tables, you find a line bar according to ISO-classification.

Below you find the ordering number of the indexable insert, most suitable for you: LC225S in the blue range.

You need the most suitable cutting value recommendations for the tool selected.

At the end of each register, you find the respective cutting value tables.

You find your material and our recommendation for the carbide grade and the cutting values in the corresponding colour range.

	Stahl, Stahlguss, rostfreier Stahl, ferritisch und martensitisch Steel, cast steel, stainless steel, ferritic and martensitic
	Rostfreier Stahl und Stahlguss, austenitisch und austenitisch/ferritisch Stainless steel and cast steel, austenitic and austenitic/ferritic
	Grauguss, Sphäroguss, Temperguss Grey cast iron, cast iron with spheroidal graphite, malleable cast iron
	Aluminium und andere Nichteisenmetalle, Kunststoffe, Graphit Aluminium and other non ferrous metals, plastic, graphite
	Hochwärmfeste Stähle, Super- und Titanlegierungen High temperature alloys, super and titanium alloys
	Gehärteter Stahl und Stahlguss Hardened steel and cast steel

Anhang Attachment

Werkstoffe – Vergleichstabelle
Material Comparison Chart

Deutschland Germany		USA U.S.A.	Frankreich France	Italien Italy	Großbritannien Great Britain	
ISO	W-Nr.	DIN	AISI/SAE	AFNOR	UNI	BS
P	Baustahl und Vergütungsstahl Construction steels					
	1.0050	St50	A570Gr50	A50-2	Fe490	Fe490-2FN
	1.0501	C35	1035	CC35	C35	060A35
	1.0503	C45	1045	CC45	C45	080M46
	1.0601	C60	1060	CC55	C60	080A62
	1.0715	9SMn28	1213	S250	CF9SMn28	230M07
	1.0718	9SMnPb28	12L13	S250Pb	CF9SMnPb28	-

N = Anzahl der Schneidkanten N = Number of cutting edges		Schneidstoffsorten Cutting materials Ident No.									
ISO-Code Cat.No.	ISO-Code Cat.No.	ISO-Code Cat.No.	ISO-Code Cat.No.	ISO-Code Cat.No.	ISO-Code Cat.No.	ISO-Code Cat.No.	ISO-Code Cat.No.	ISO-Code Cat.No.	ISO-Code Cat.No.	ISO-Code Cat.No.	ISO-Code Cat.No.
1187-00	SNKX 0904 AN	1052116	1052117	1052118	1052119	1052120	1052121	1052122	1052123	1052124	1052125
1187-10	SNKX 1205 AN	1052301	1052302	1052303	1052304	1052305	1052306	1052307	1052308	1052309	1052310
1187-10 TR	SNKX 1205 AN-TR	1052218	1052219	1052220	1052221	1052222	1052223	1052224	1052225	1052226	1052227

FETTE

Schnittwertempfehlungen für Plan- und Eckfräsköpfe
Cutting Data Recommendations for Face Milling Cutters

ISO-Code	Werkstoff Material	R _m /UTS (N/mm ²)	empfohlene HM-Sorte recommended Carbide Grade	Vorschub pro Zahn mm Feed per tooth mm			Leistung Efficiency cm ³ /min
				Schlichten Finishing	Schuppen Roughing	Schnittgeschwindigkeit Cutting speed v _c m/min	
	Unlegierter Baustahl	Plain carbon steel	700	0,1	0,3	0,5	220
	Automatenstahl	Free cutting steel	700	0,1	0,3	0,5	180
	Baustahl	Structural alloy steel	500 - 950	0,1	0,3	0,5	180
	Vergütungsstahl, mittelstark	Heat-treatable steel, medium strength	500 - 950	0,1	0,3	0,5	160
	Stahlguss	Cast steel	950	0,1	0,3	0,5	160
	Einsatzstahl	Case hardening steel	950	0,1	0,3	0,5	160
	Roht- und Sinterhartmetalle	Stainless steel	500 - 950	0,1	0,3	0,5	170

	Werkstoff	Material	R_m/UTS (N/mm²)	Beispiel Example	DIN-No.	
Blue	Unlegierter Baustahl	Plain carbon steel	- 700	St 52	1.0052	
	Automatenstahl	Free cutting steel	- 700	9 SMn 28	1.0715	
	Baustahl	Structural alloy steel	500 – 950	Ck 45, 26 CrMo 4	1.1191 1.7219	
	Vergütungsstahl, mittelfest	Heat-treatment steel, medium strength	500 – 950	42 CrMo 4 50 CrV 4	1.7225 1.2241	
	Stahlguß	Cast steel	- 950	GS 40	1.0416	
	Einsatzstahl	Case hardening steel	- 950	16 MnCr 5	1.7131	
	Rost- und säurebeständiger Stahl, ferritisch, martensitisch	Stainless steel, ferritic, martensitic	500 – 950	X 10 Cr 13 X 12 CrMoS 17 X 35 CrMo 17	1.4006 1.4104 1.4122	
	Vergütungsstahl, hochfest	Heat-treatment steel, high strength	950 – 1400	42 CrMo 4 30 CrNiMo 8	1.7225 1.6580	
	Nitrierstahl, vergütet	Nitriding steel, heat treated	950 – 1400	34 CrAl6	1.8504	
	Werkzeugstahl	Tool steel	950 – 1400	X 38 CrMoV 5 1 X 155 CrVMo 12 1	1.2343 1.2379	
	Yellow	Rost- und säurebeständiger Stahl, austenitisch	Stainless steel, austenitic	500 – 950	X 5 CrNi 18 10 X 10 CrNiMo 18 10	1.4301 1.4571
		Martensitaushärtbarer Stahl	Maraging steel			1.2709
	Red	Grauguss	Grey cast iron	100 – 400 (120 – 260 HB)	GG25	0.6025
		Legierter Grauguss	Alloyed grey cast iron	150 – 300 (160 – 230 HB)	GGL-NiCr 35 2	0.6678
Sphäroguss		Nodular cast iron	400 – 800 (120 – 310 HB)	GGG60	0.7060	
Temperguss		Malleable cast iron	350 – 700 (150 – 280 HB)	GTS55	0.8155	
Green	Rein-Metalle, weich	Pure metals, soft	- 500	Reineisen, Blei pure iron, lead		
	Aluminium-Legierungen, langspanend	Aluminium alloys, long chipping	- 550	AlMg 3 AlZnMgCu 1,5	3.3535 3.4365	
	Aluminium-Legierungen, kurzspanend	Aluminium alloys, short chipping	- 400	G-AlSi 12	3.2581	
	Kupfer-Legierungen, langspanend	Copper alloys, long chipping	300 – 700	MS63 CuAl10Ni	2.0320 2.0975	
	Kupfer-Legierungen, kurzspanend	Copper alloys, short chipping	- 500	MS58	2.0402	
	Magnesium-Legierungen	Magnesium alloys	160 – 300	G-MgAl9Zn1	3.5912	
	Thermoplaste	Thermoplastics	40 – 70	PVC, Acrylglas PVC, acrylic glass		
	Duroplaste Graphit	Duroplastics Graphite	20 – 40	Bakelit, Melamin Graphite		
Orange	Titan-Legierungen, mittelfest	Titanium alloys, medium strength	- 950	TiAl5Sn2,5 TiAl6V4	3.7115 3.7165	
	Titan-Legierungen, hochfest	Titanium alloys, high strength	900 – 1400	TiAl6Sn2	3.7174	
	Nickelbasis-Legierungen, mittelfest	Nickel based alloys, medium strength	- 950	NiCr12Al6MoNb	2.4670	
	Nickelbasis-Legierungen hochwarmfest	Heat resistant nickel based alloys, high strength	900 – 1400	NiCr19Fe19NbMo	Inconel 718	
Grey	Hartguss	Chilled cast iron	300 – 600	Ni-hard, Ampco		
	Gehärteter Stahl	Hardened steel	45-52 HRC 53-59 HRC 60-65 HRC			



Fräswerkzeuge mit Wendeplatten

Milling Cutters with Indexable Inserts

Wendeplatten Indexable Inserts	19
Einstellbare modulare Fräsesysteme Adjustable Modular Milling Cutter Systems	
Multi-Mill-Fräsesystem Multi-Mill-Milling Cutter System	73
Messerkopfsysteme Milling Cutter Systems	97
Plan- und Eckfräsköpfe Face Milling Cutters	121
Schaft- und Walzenstirnfräser End and Shell End Mills	145
Kopierfräser Copy Milling Cutters	175
Scheibenfräser und Trennfräser Side Milling Cutters	225
Zahnformfräser Form Milling Cutters	233

Direkte Suche

Direct reference

Planfräsköpfe

Face Milling Cutters

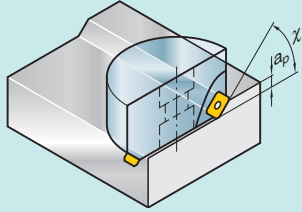

Cat.-No.	WP Insert	κ	a_p	Seite Page
FCT XX	OCKX	45°	8	124
FCT 45	OCKX	45°	8	124
FMT 45-09	SNKX	45°	5	126
FMT 45-12	SNKX	45°	7	126
FMH 45B	SEKN	45°	5,5	138
FMH 45	SEKN	45°	5,5	136
FMH 45A	SEHW	45°	5,5	124
FMV 45	SNHX	45°	5	134

Eckfräsköpfe

Face Milling Cutters

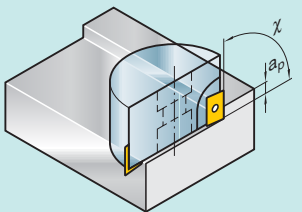

Cat.-No.	WP Insert	κ	a_p	Seite Page
FMU90	ADHX	90°	12	130
FMH90	APKT	90°	14	132
FMT90-09	SPKX	90°	7	128
FMT90-12	SPKX	90°	10	128

UNIVEX-Schaftfräser 90°

UNIVEX End Mills 90°

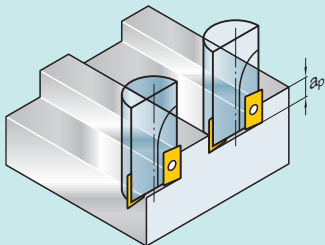

Cat.-No.	WP Insert	a_p	Seite Page
EMU90	ADHX	9 - 10,5	148
EMH90-10	APKT	8	156
EMH90-16	APKT	14	156

Planfräsköpfe

Face Milling Cutters

Multi-Mill

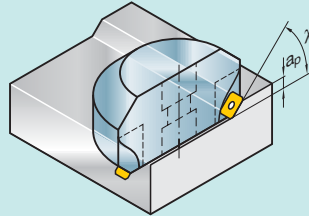

Cat.-No.	WP Insert	κ	a_p	Seite Page
MMH 45-12	SEKN	45°	5,5	76
MMH 45-15	SEKN	45°	9	77
MMH 45A	SEKN	45°	5,5	78
MMH 45B	SEHW	45°	5,5	79
MMT 45	SNKX	45°	5,5	80
MCT 45	OCKX	45°	8	81
MMP 75	SPKN	75°	9	82

Eckfräsköpfe

Face Milling Cutters

Multi-Mill

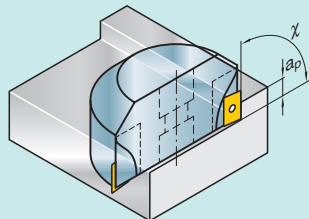

Cat.-No.	WP Insert	κ	a_p	Seite Page
MMT 87	SNKX	87°	10	83
MMH 88A	SEHN	88°	10	84
MMT 88B	SEHW	88°	10	85
MMT 90	SPKX	90°	10	86
MMP 90-16	TPKN	90°	12	87
MMP 90-22	TPKN	90°	18	88
MMH90	APKT	90°	14	89
MCT	RCHT	rund round	8	90

Bohrnutenfräser

Slot Drills

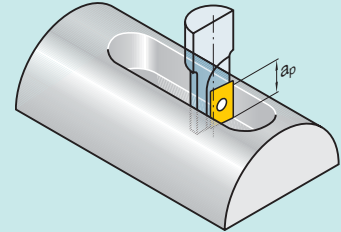

Cat.-No.	WP Insert	a_p	Seite Page
ESP 90	CCHX	7 - 13	158

Walzenstirn-Schruppfräser

Roughing Shell End Mills

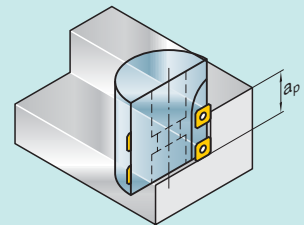

Cat.-No.	WP Insert	a_p	Seite Page
FRT 90	SNKX	28 - 45	161
FRP 90	SDMW	28 - 56	169

Schaft-Schruppfräser

Roughing End Mills

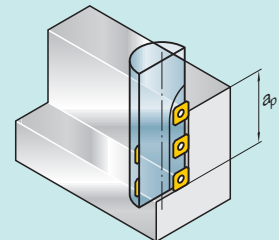

Cat.-No.	WP Insert	a_p	Seite Page
ERU90	ADMX	17 - 75	152
ERT90	SNKX	47 - 70	161

Direkte Suche Direct reference

Fasenfräser Bevel Milling Cutters

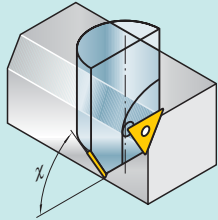

Cat.-No.	WP Insert	α	Seite Page
EFZ	TCMT	30°-45°-60°	162

Fasenfräser Bevel Milling Cutters

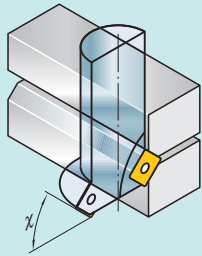

Cat.-No.	WP Insert	α	Seite Page
EFZ 45	SDMT	45°	165
EFZ 45	SPMT	45°	165

Schrupp-Kopierfräser für NE-Metalle Roughing Copying Cutters for Non-ferrous Metals

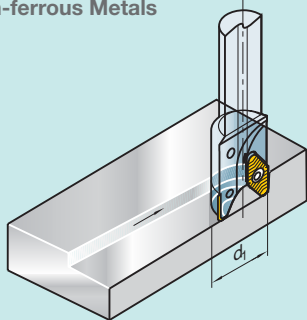

Cat.-No.	WP Insert	d_1	Seite Page
EMZ 90	VGPT/ VCGT	20 - 42	180
FMZ 90	VGPT/ VCGT	42 - 125	180

Twincut-Feed Twincut-Feed

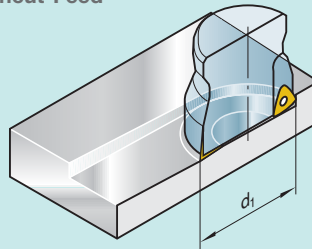

Cat.-No.	WP Insert	d_1	Seite Page
ECP 05	1177	20 - 42	178
FCP 05	1177	42 - 66	178

Schaft-Kopierfräser Copying End Mills

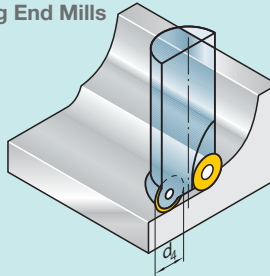

Cat.-No.	WP Insert	d_4	Seite Page
ECZ	RDHW	5 - 16	189
ECT	RCHX	5 - 6	183

Kopierfräsköpfe Copying Milling Cutters

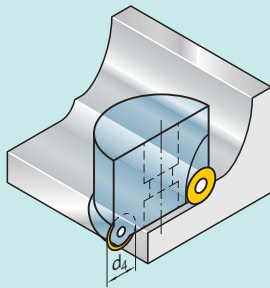

Cat.-No.	WP Insert	d_4	Seite Page
FCZ	RDHW	10 - 16	186
FCT	RCHX	10 - 16	183

Kugel-Kopierfräser Ball Nose Copying Mills

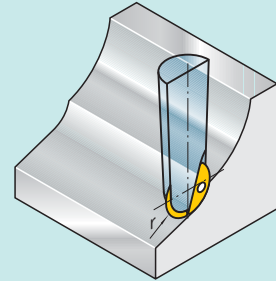

Cat.-No.	WP Insert	r	Seite Page
EBT	1179	8 - 16	197
EBG R (GWR)	WPR	6 - 32	199

Kugel-Kopierschruppfräser Ball Nose Roughing End Mills

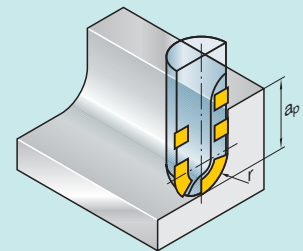

Cat.-No.	WP Insert	r	a_p	Seite Page
EBT	1179	10 - 25	30 - 60	193
EBG T (GRT)	WR_	12,5 - 16	46 - 120	194

Direkte Suche Direct reference

Schaft-Schlichtfräser Finishing End Mills

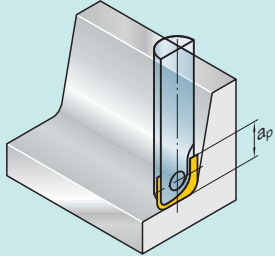

Cat.-No.	WP Insert	a _p	Seite Page
EBG V (GWW)	WPV WPB	8 - 32	210

T-Nutenfräser T-Slot Cutters

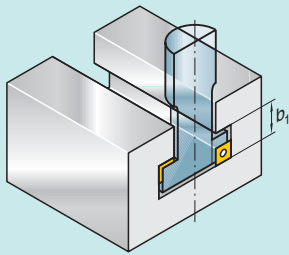

Cat.-No.	WP Insert	b ₁	Seite Page
ESP 90	CCMT	11 - 21	166

Gewindefräser Thread Milling Cutters

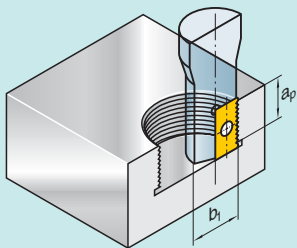

Cat.-No.	WP Insert	d ₁	a _p	Seite Page
ETZ 90	1144	16 - 36	14,3 - 25,4	170

Scheibenfräser Side Milling Cutters

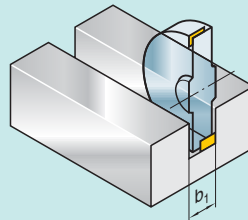

Cat.-No.	WP Insert	b ₁	Seite Page
SMN 90	1186	5 - 10	228

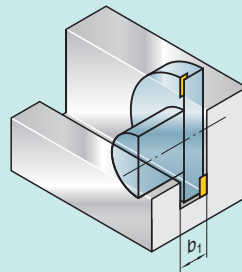

Cat.-No.	WP Insert	b ₁	Seite Page
SMN 90F	LNHX	6 - 10	228

Zahnformfräser Gear Milling Cutters

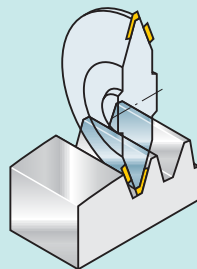

Cat.-No.		Seite Page
2667	Zahnform-Schruppfräser Gear Roughing Cutters	237
2675	Zahnform-Fertigfräser Gear Finishing Cutters	238
2695	Rotoren-Vorfräser Roughing Cutters for Rotors	240
2690	Rotoren-Profilfräser Rotor Profile Cutters	242

Messerkopfsysteme (1D, 2D-Mini, 2D, 3D) Milling Cutter Systems (1D, 2D-Mini, 2D, 3D)

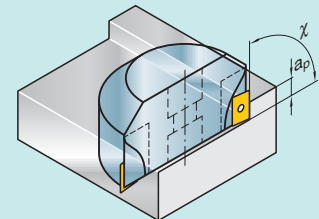
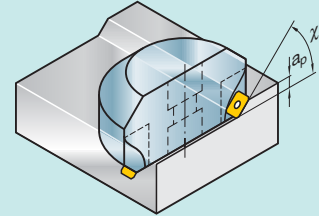

Cat.-No.	WP Insert	α	a _p	Seite Page
1D-MK	IT SEHT ADHT	90°/75°	0-12*	98
2D-Mini-MK	SDGW CDGW	90°/75°	0-12*	104
2D-MK	SPGW CPGW SEHT ADHT	75°	0-12*	106
3D-MK	SPGW CPGW SEHT ADHT	90°	0-12*	106

* je nach Anwendungsfall
* according to the application

Hartmetall-Wendeplatten

Carbide Indexable Inserts

ISO-Bezeichnungssystem für Fräswendeplatten ISO designation system for Indexable Inserts for milling	20
Schneidstoffsorten Milling grades	22
ISO-Fräswendeplatten ISO Indexable Inserts for milling	24
LMT-Fräswendeplatten LMT Indexable Inserts for milling	30

ISO-Wendepplattenbezeichnung



ISO Indexable Insert designation

S Grundform Insert shape	N Freiwinkel Clearance angle	K Toleranzen Tolerances	X Spanformer, Befestigung Chip breaker, clamp type	12 Schneidenlänge Cutting edge length																																																																																																																																																															
A 85°	 α_n	<table border="1"> <thead> <tr> <th></th> <th>m</th> <th>s</th> <th>d</th> </tr> </thead> <tbody> <tr><td>A</td><td>± 0,005</td><td>± 0,025</td><td>± 0,025</td></tr> <tr><td>C</td><td>± 0,013</td><td>± 0,025</td><td>± 0,025</td></tr> <tr><td>E</td><td>± 0,025</td><td>± 0,025</td><td>± 0,025</td></tr> <tr><td>F</td><td>± 0,005</td><td>± 0,025</td><td>± 0,013</td></tr> <tr><td>G</td><td>± 0,025</td><td>± 0,13</td><td>± 0,025</td></tr> <tr><td>H</td><td>± 0,013</td><td>± 0,025</td><td>± 0,013</td></tr> <tr><td>J</td><td>± 0,005</td><td>± 0,025</td><td>siehe see Tab. 4</td></tr> <tr><td>K</td><td>± 0,013</td><td>± 0,025</td><td>siehe see Tab. 4</td></tr> <tr><td>L</td><td>± 0,025</td><td>± 0,025</td><td>siehe see Tab. 4</td></tr> <tr><td>M</td><td>siehe see Tab. 5</td><td>± 0,13</td><td>siehe see Tab. 4</td></tr> <tr><td>N</td><td>siehe see Tab. 5</td><td>± 0,025</td><td>siehe see Tab. 4</td></tr> <tr><td>U</td><td>siehe see Tab. 5</td><td>± 0,13</td><td>siehe see Tab. 4</td></tr> </tbody> </table>		m	s	d	A	± 0,005	± 0,025	± 0,025	C	± 0,013	± 0,025	± 0,025	E	± 0,025	± 0,025	± 0,025	F	± 0,005	± 0,025	± 0,013	G	± 0,025	± 0,13	± 0,025	H	± 0,013	± 0,025	± 0,013	J	± 0,005	± 0,025	siehe see Tab. 4	K	± 0,013	± 0,025	siehe see Tab. 4	L	± 0,025	± 0,025	siehe see Tab. 4	M	siehe see Tab. 5	± 0,13	siehe see Tab. 4	N	siehe see Tab. 5	± 0,025	siehe see Tab. 4	U	siehe see Tab. 5	± 0,13	siehe see Tab. 4	<table border="1"> <thead> <tr> <th colspan="2">Tab. 4</th> <th>d</th> <th>J, K, L, M</th> <th>U</th> </tr> <tr> <th>über</th> <th>bis</th> <th colspan="3"></th> </tr> <tr> <th>over</th> <th>up to</th> <th colspan="3"></th> </tr> </thead> <tbody> <tr><td>3,9</td><td>10,0</td><td>± 0,05</td><td colspan="2">± 0,08</td></tr> <tr><td>10,0</td><td>15,0</td><td>± 0,08</td><td colspan="2">± 0,13</td></tr> <tr><td>15,0</td><td>20,0</td><td>± 0,10</td><td colspan="2">± 0,18</td></tr> <tr><td>20,0</td><td>26,0</td><td>± 0,13</td><td colspan="2">± 0,25</td></tr> <tr><td>26,0</td><td>32,0</td><td>± 0,15</td><td colspan="2">± 0,25</td></tr> </tbody> </table>	Tab. 4		d	J, K, L, M	U	über	bis				over	up to				3,9	10,0	± 0,05	± 0,08		10,0	15,0	± 0,08	± 0,13		15,0	20,0	± 0,10	± 0,18		20,0	26,0	± 0,13	± 0,25		26,0	32,0	± 0,15	± 0,25		<table border="1"> <thead> <tr> <th colspan="2">Tab. 5</th> <th>M, N</th> <th>m</th> <th>U</th> </tr> <tr> <th>über</th> <th>bis</th> <th colspan="3"></th> </tr> <tr> <th>over</th> <th>up to</th> <th colspan="3"></th> </tr> </thead> <tbody> <tr><td>3,9</td><td>10,0</td><td>±0,08</td><td colspan="2">±0,13</td></tr> <tr><td>10,0</td><td>15,0</td><td>±0,13</td><td colspan="2">±0,20</td></tr> <tr><td>15,0</td><td>20,0</td><td>±0,15</td><td colspan="2">±0,27</td></tr> <tr><td>20,0</td><td>26,0</td><td>±0,18</td><td colspan="2">±0,38</td></tr> <tr><td>26,0</td><td>32,0</td><td>±0,20</td><td colspan="2">±0,38</td></tr> </tbody> </table>	Tab. 5		M, N	m	U	über	bis				over	up to				3,9	10,0	±0,08	±0,13		10,0	15,0	±0,13	±0,20		15,0	20,0	±0,15	±0,27		20,0	26,0	±0,18	±0,38		26,0	32,0	±0,20	±0,38		<table border="1"> <thead> <tr> <th></th> <th>I</th> </tr> </thead> <tbody> <tr><td>06</td><td>6,350</td></tr> <tr><td>07</td><td>7,938</td></tr> <tr><td>09</td><td>9,525</td></tr> <tr><td>11</td><td>11,000</td></tr> <tr><td>12</td><td>12,700</td></tr> <tr><td>15</td><td>15,875</td></tr> <tr><td>16</td><td>16,500</td></tr> <tr><td>19</td><td>19,050</td></tr> <tr><td>22</td><td>22,000</td></tr> <tr><td>25</td><td>25,400</td></tr> <tr><td>31</td><td>31,750</td></tr> <tr><td>38</td><td>38,100</td></tr> </tbody> </table>		I	06	6,350	07	7,938	09	9,525	11	11,000	12	12,700	15	15,875	16	16,500	19	19,050	22	22,000	25	25,400	31	31,750	38	38,100
		m	s	d																																																																																																																																																															
A		± 0,005	± 0,025	± 0,025																																																																																																																																																															
C		± 0,013	± 0,025	± 0,025																																																																																																																																																															
E		± 0,025	± 0,025	± 0,025																																																																																																																																																															
F		± 0,005	± 0,025	± 0,013																																																																																																																																																															
G		± 0,025	± 0,13	± 0,025																																																																																																																																																															
H		± 0,013	± 0,025	± 0,013																																																																																																																																																															
J		± 0,005	± 0,025	siehe see Tab. 4																																																																																																																																																															
K		± 0,013	± 0,025	siehe see Tab. 4																																																																																																																																																															
L	± 0,025	± 0,025	siehe see Tab. 4																																																																																																																																																																
M	siehe see Tab. 5	± 0,13	siehe see Tab. 4																																																																																																																																																																
N	siehe see Tab. 5	± 0,025	siehe see Tab. 4																																																																																																																																																																
U	siehe see Tab. 5	± 0,13	siehe see Tab. 4																																																																																																																																																																
Tab. 4		d	J, K, L, M	U																																																																																																																																																															
über	bis																																																																																																																																																																		
over	up to																																																																																																																																																																		
3,9	10,0	± 0,05	± 0,08																																																																																																																																																																
10,0	15,0	± 0,08	± 0,13																																																																																																																																																																
15,0	20,0	± 0,10	± 0,18																																																																																																																																																																
20,0	26,0	± 0,13	± 0,25																																																																																																																																																																
26,0	32,0	± 0,15	± 0,25																																																																																																																																																																
Tab. 5		M, N	m	U																																																																																																																																																															
über	bis																																																																																																																																																																		
over	up to																																																																																																																																																																		
3,9	10,0	±0,08	±0,13																																																																																																																																																																
10,0	15,0	±0,13	±0,20																																																																																																																																																																
15,0	20,0	±0,15	±0,27																																																																																																																																																																
20,0	26,0	±0,18	±0,38																																																																																																																																																																
26,0	32,0	±0,20	±0,38																																																																																																																																																																
	I																																																																																																																																																																		
06	6,350																																																																																																																																																																		
07	7,938																																																																																																																																																																		
09	9,525																																																																																																																																																																		
11	11,000																																																																																																																																																																		
12	12,700																																																																																																																																																																		
15	15,875																																																																																																																																																																		
16	16,500																																																																																																																																																																		
19	19,050																																																																																																																																																																		
22	22,000																																																																																																																																																																		
25	25,400																																																																																																																																																																		
31	31,750																																																																																																																																																																		
38	38,100																																																																																																																																																																		
B 82°		Tab. 4		 																																																																																																																																																															
C 80°		Tab. 5																																																																																																																																																																	
D 55°		Tab. 4																																																																																																																																																																	
E 75°		Tab. 5																																																																																																																																																																	
H 120°		A 3°	Tab. 4																																																																																																																																																																
K 55°		B 5°	Tab. 5																																																																																																																																																																
L 90°		C 7°	Tab. 4																																																																																																																																																																
M 86°		D 15°	Tab. 5																																																																																																																																																																
O 135°		E 20°	Tab. 4																																																																																																																																																																
P 108°		F 25°	Tab. 5																																																																																																																																																																
R -	G 30°	Tab. 4																																																																																																																																																																	
S 90°	N 0°	Tab. 5																																																																																																																																																																	
T 60°	P 11°	Tab. 4																																																																																																																																																																	
V 35°	O	Tab. 5																																																																																																																																																																	
W 80°	Normalfreiwinkel, die eine besondere Beschreibung erfordern Normal clearance angles, which require a special description	Tab. 4																																																																																																																																																																	

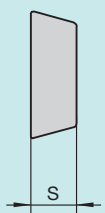
() Kegelwinkel für Schraube Cone angle for screw

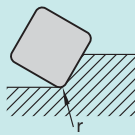
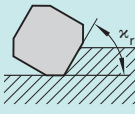
05 Dicke Thickness	
	
	S
02	2,38
03	3,18
T3	3,97
04	4,76
05	5,56
06	6,35
07	7,94
08	8,00
09	9,52

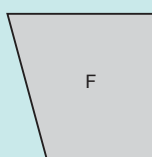
AN Schneidenecke Cutting edge corner	
Für Radiusplatten For radius inserts	
	
	Eckradius-r Corner radius-r
00	scharfkantig sharp-edged
02	0,2
04	0,4
08	0,8
12	1,2
16	1,6
20	2,0
	usw. etc.
Für Fasenplatten Planschneiden For chamfered insert face milling	
	
	Einstellwinkel Setting angle
	α_r
A	45°
D	60°
E	75°
F	85°
P	90°
Z	Sonder Special
	Frei < der Planschneide Clearance < of face milling edge
	α_n
A	3°
B	5°
C	7°
D	15°
E	20°
F	25°
G	30°
N	0°
P	11°
Z	Sonder Special
MO	Rundwende- platte metrisch Round insert metric
OO	Rundwende- platte Zoll Round insert Inch

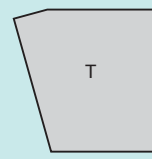
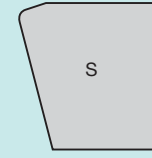
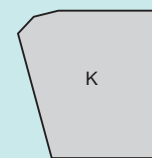
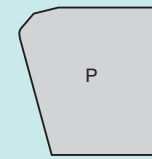
E Schneidenausführung ¹⁾ Cutting edge type ¹⁾	
	
	scharfkantig sharp-edged
	
	gerundet rounded
	
	gefäst chamfered
	
	gefäst und gerundet chamfered and rounded
	
	doppelgefäst double chamfered
	
	doppelgefäst und gerundet double chamfered and rounded

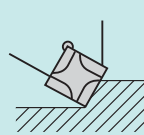
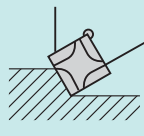
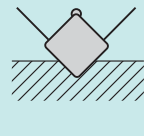
N Schneidrichtung ¹⁾ Direction of cut ¹⁾	
R	
	nur rechtsschneidend RH cut only
L	
	nur linksschneidend LH cut only
N	
	rechts- und links- schneidend RH and LH cut
	¹⁾ Die Anwendung dieser Kennbuch- staben ist freige- stellt.
	¹⁾ The use of these reference letters is left open.

- TR LMT-Norm LMT-Standard																				
TR	Spanflächentopographie Geometry																			
CF	Spanformer Chip breaker																			
T	breite Schneidkantenfäse bevelled cutting edge																			
TT	Extra stabile Schruppgeometrie Heavy duty roughing geometry																			
ALC	Al-Geometrie Al geometry																			
ALM	Al-Geometrie, Formenbau Al geometry die and mould																			
BM	Geometrie für NIR. Geometry for stainless																			
BP	Hochleistungsgeometrie für Stahl High performance geometry for steel																			
Beispiel:																				
	<table border="1"> <tr> <td>S</td><td>N</td><td>K</td><td>X</td><td>12</td><td>05</td><td>AN</td><td>E</td><td>N-TR</td> </tr> <tr> <td># 1</td><td>2</td><td>3</td><td>4</td><td>5</td><td>6</td><td>7</td><td>8</td><td>9</td><td>10</td> </tr> </table>	S	N	K	X	12	05	AN	E	N-TR	# 1	2	3	4	5	6	7	8	9	10
S	N	K	X	12	05	AN	E	N-TR												
# 1	2	3	4	5	6	7	8	9	10											
1	Grundform	quadratisch																		
2	Freiwinkel	0°																		
3	Toleranzen	m ± 0,013 s ± 0,025 d ± 0,13																		
4	Befestigung Spanfläche	mit Besonderheit nach Zeichnung																		
5	Schneidenlänge	12,7																		
6	Dicke	5,56																		
7	Schneidenecke	45° Fase																		
8	Schneidkante	gerundet																		
9	Schneidrichtung	rechts- und links- schneidend																		
10	Interne Bezeichnung	TR = Spanflächen- topographie																		
Example:																				
1	Basic form	square																		
2	Clearance angle	0°																		
3	Tolerances	m ± 0,013 s ± 0,025 d ± 0,13																		
4	Fixing Cutting face	with special feature acc. to drawing																		
5	Length of cutting edge	12,7																		
6	Thickness	5,56																		
7	Cutting edge corner	45° chamfer																		
8	Cutting edge	rounded																		
9	Direction of cut	right- and lefthand cutting																		
10	Internal designation	TR = Geometry																		

Abmessungen in mm Dimensions in mm

Wendepplatten-Bezeichnung ISO 1832.2 DIN 4987
Indexable insert designation

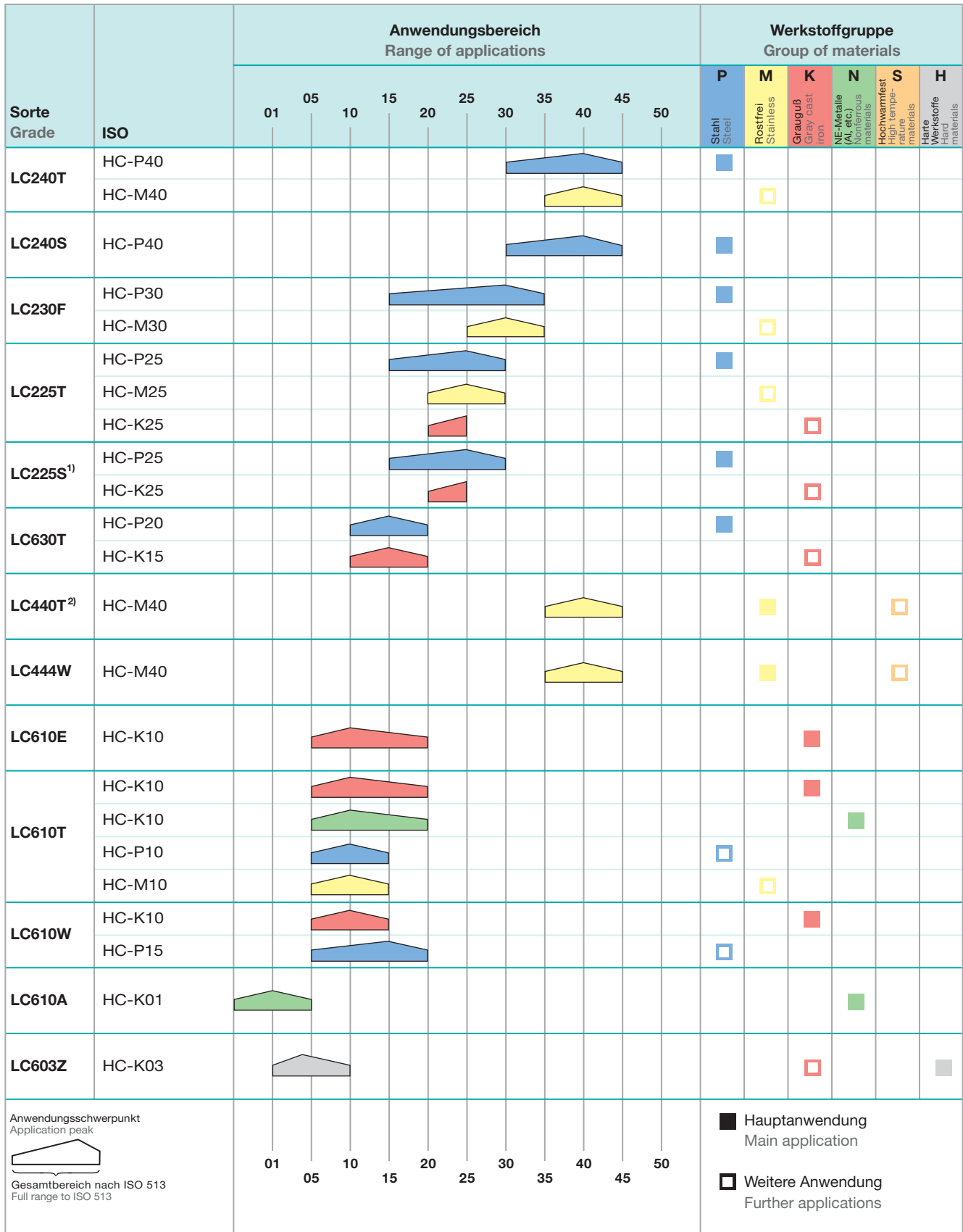



¹⁾ Auch zur Gewindebearbeitung geeignet
¹⁾ Also usable for threading

²⁾ Vorzugsweise für Trockenbearbeitung mit hohen Schnittgeschwindigkeiten
²⁾ Preferably for dry machining with high cutting speeds

Technische Hinweise Technical tips

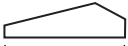
Unbeschichtete LMT-Schneidstoffsorten Fräsen Uncoated LMT milling grades

Sorte Grade	ISO	Anwendungsbereich Range of applications										Werkstoffgruppe Group of materials									
		01	05	10	15	20	25	30	35	40	45	50	P	M	K	N	S	H			
LW240	HW-P40													■							
LW225	HW-P25													■							
LW610	HW-K10														□			■			
Anwendungsschwerpunkt Application peak  Gesamtbereich nach ISO 513 Full range to ISO 513												■ Hauptanwendung Main application □ Weitere Anwendung Further applications									
												Stahl Steel Rostfrei Stainless Grauguß Gray cast iron NE-Metalle (Nickel, Titan) Nonferrous materials Hochwärmest High temperature materials Harte Werkstoffe Hard materials									

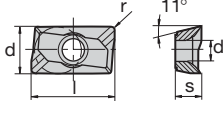
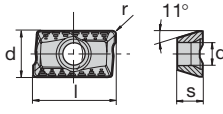
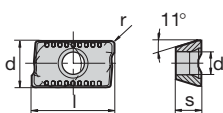
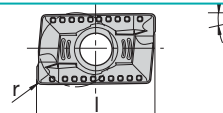
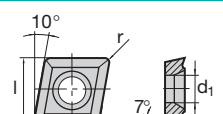
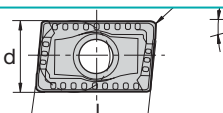
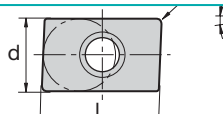
N = Anzahl der Schneidkanten N = Number of cutting edges						ISO-Code	Schneidstoffsorten Cutting materials										Für Fräser For cutter Cat-No.				
	l	s	d	d ₁	b/r		LC240T	LC230F	LC225T	LC225S	LW225	LC440T	LC444W	LC610E	LC610T	LC610T		LC610A	LW610		
	10,96	3,5	6,6	2,8	0,5	APHT 1003PDFR-ALC													EMH90 FMH90		
	17,3	5,26	9,52	4,5	0,8	APHT 1604PDFR-ALC									●			●		EMH90 FMH90 MMH90	
N = 2																					
	10,96	3,5	6,6	2,8	0,5	APKT 1003PDSR-BM							●						EMH90 FMH90		
	17,3	5,26	9,52	4,5	0,8	APKT 1604PDSR-BM							●							EMH90 FMH90 MMH90	
N = 2																					
	10,96	3,5	6,6	2,8	0,5	APKT 1003PDSR-BP	●	●	●	●	●	●							EMH90 FMH90		
	17,3	5,26	9,52	4,5	0,8	APKT 1604PDSR-BP	●	●	●	●	●	●		●						EMH90 FMH90 MMH90	
	17,3	5,26	9,52	4,5	1,6	APKT 160416SR-BP			●	●	●										
	17,3	5,26	9,52	4,5	2,4	APKT 160424SR-BP			●	●	●										
	17,3	5,26	9,52	4,5	3,2	APKT 160432SR-BP			●	●	●										
N = 2																					
	16,33	4,36		4,5	0,6	APKT 15T3PDTR-BP	●														
N = 2																					
	6,35	2,38	6,35	2,8	0,4	CCMT 060204	●		●	●	●			●					ESP90		
	7,94	3,18	7,94	3,4	0,8	CCMT 080308	●		●	●	●			●							
	9,52	3,97	9,52	4,4	0,8	CCMT 09T308			●	●	●										
	12,7	4,76	12,7	5,5	0,8	CCMT 120408			●	●	●										
N = 2																					
	15,7	4,76	9,52	4,5	0,8	LDKT 1504PDSR	●	●			●										
N = 2																					
	15	3,18	9,52	4,5	0,8	LDLX 150308R		●	○		●		●								
N = 2																					

Bestellbeispiel Order example: 10 Stk off APHT 1003PDFR-ALC LC610T

● Verfügbar ab Lager Available from stock ○ Auf Anfrage On request

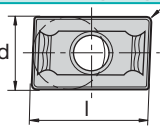
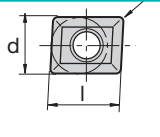
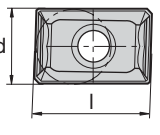
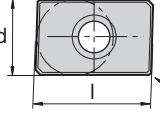
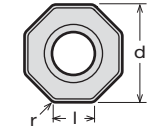
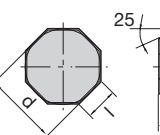
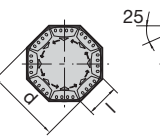
N = Anzahl der Schneidkanten N = Number of cutting edges							ISO-Code	Schneidstoffsorten Cutting materials										Für Fräser For cutter Cat-No.
	l	s	d	d ₁	b/r			LC240T	LC230F	LC225T	LC225S	LW225	LC440T	LC444W	LC610E	LC610T	LC610A	
	15	3,18	9,52	4,5	0,8		LDLX 150308R-050	●	○		●							
N = 2																		
	7,93	3,18	6,35	2,8	0,4		LPLX 070304R	●	○		●							
N = 2																		
	15,88	4,76	12,7	5,5	0,8		LPLX 1504PPR-050	●	○		●							
N = 2																		
	15,88	4,76	12,7	5,5	0,8		LPLX 1504PPSR		○		●							
	20	4,76	12,7	5,6	0,8		LPLX 2004PPSR				●							
N = 2																		
	6,58	5,56	15,88	5,5	0,8		ODMW 060508EN					●						
	6,58	5,56	15,88	5,5	0,8		ODMW 060508SN	●	●		●							
N = 8																		
	7,4	4,76	18,1				OFEN 070405SN	●	●		●							
N = 8																		
	7,4	4,76	18,1				OFER 070405SN-BP	●	●		●							
N = 8																		

Bestellbeispiel Order example: 10 Stk off LDLX 150308R-050 LC230F

● Verfügbar ab Lager Available from stock
○ Auf Anfrage On request

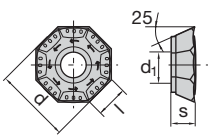
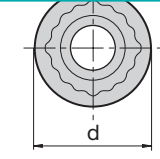
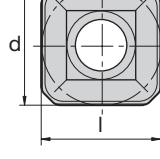
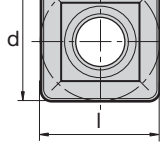
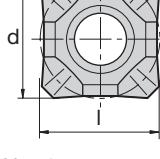
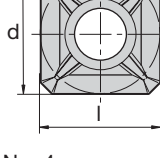
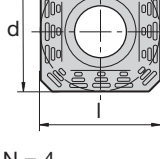
N = Anzahl der Schneidkanten N = Number of cutting edges						ISO-Code	Schneidstoffsorten Cutting materials										Für Fräser For cutter Cat-No.	
	l	s	d	d ₁	b/r		LC240T	LC230F	LC225T	LC225S	LW225	LC440T	LC444W	LC610E	LC610T	LC610T		LC610A
 N = 8	7,4	3,97	12,7	4,6		OFEX 05T305SN-BP	●	●		●								
 N = 4		4,76	12,7	5,5		RPMT 120400SN	●	●		●								
 N = 4	12,7	5,56	12,7	5,5		SCKT 1205ACTN	●	○		●								
 N = 4	12,7	5,56	12,7	5,5	1,2	SCMX 120512	●	○		●								
 N = 4	12,7 15,88	4,76	12,7 15,88	5,5		SDHT 1204AEFN-ALC SDHT 1504AEFN-ALC								●	●	●		
 N = 4	12,7 15,88	4,76	12,7 15,88	5,5		SDHT 1204AESN SDHT 1504AESN	●	●		●								
 N = 4	12,7	4,76	12,7	5,5		SDHT 1204AESN-BM						●						

Bestellbeispiel Order example: 10 Stk off OFEX 05T305SN-BP

● Verfügbar ab Lager Available from stock
○ Auf Anfrage On request

N = Anzahl der Schneidkanten N = Number of cutting edges						ISO-Code	Schneidstoffsorten Cutting materials										Für Fräser For cutter Cat-No.		
	l	s	d	d ₁	b/r		LC240T	LC230F	LC225T	LC225S	LW225	LC440T	LC444W	LC610E	LC610T	LC610T		LC610A	LW610
 N = 4	12,7	4,76	12,7	5,5		SDHW 1204AEEN						●	●						
	12,7	4,76	12,7	5,5		SDHW 1204AESN	●	●		●									
	15,88	4,76	15,88	5,5		SDHW 1504AEEN						●							
	15,88	4,76	15,88	5,5		SDHW 1504AESN	●												
 N = 4	9,52	3,18	9,52	4		SDMT 090308			●									EFZ45	
	12,7	4,76	12,7	5,5	0,8	SDMT 120408SN	●			●									
 N = 4	12,7	5,0	12,7	4,4	0,8	SDMT 1205PDSR-BP	●	○		●									
 N = 4	9,52	3,18	9,52	4	0,8	SDMW 090308	●		○	●	●								
 N = 4	12,7	4,76	12,7	5,5		SEHT 1204AFFN-ALC									●	●	●	FMH45B MMH45B	
 N = 4	12,7	4,76	12,7	5,5		SEHT 1204AFSN-BM						●						FMH45B MMH45B	
 N = 4	12,7	3,18	12,7		1,4	SEKN 1203AFEN					●	●						FMH45 MMH45	
	12,7	3,18	12,7		1,4	SEAN 1203AFSN	●			●	●								
	12,7	3,18	12,7		1,4	SEKN 1203AFSN	●	●	●	●	●	●	●	●					
	12,7	4,76	12,7		1,4	SEKN 1204AFEN						●						FMH45A MMH45A	
	12,7	4,76	12,7		1,4	SEKN 1204AFSN	●	●	●	●	●	●	●	●				MMH45B	
	15,88	4,76	15,88		1,6	SEKN 1504AFEN						●						MMH45	
	15,88	4,76	15,88		1,6	SEAN 1504AFSN	●			●	●								
15,88	4,76	15,88		1,6	SEKN 1504AFSN	●	●	●	●				●						

Bestellbeispiel Order example: 10 Stk off SDHW 1204AEEN LC444W

● Verfügbar ab Lager Available from stock
○ Auf Anfrage On request

N = Anzahl der Schneidkanten N = Number of cutting edges						ISO-Code	Schneidstoffsorten Cutting materials										Für Fräser For cutter Cat-No.	
	l	s	d	d ₁	b/r		LC240T	LC230F	LC225T	LC225S	LW225	LC440T	LC444W	LC610E	LC610T	LC610A		LW610
 N = 4	12,7	3,18	12,7		1,4	SEKR 1203AFSN	●	●	●	●	●	●						FMH45 MMH45
	12,7	4,76	12,7		1,4	SEKR 1204AFSN	●	●	●	●	●	●						FMH45A MMH45A
 N = 4	12,7	3,18	12,7		1,4	SEKR 1203AFSN-BM						●					FMH45 MMH45	
	12,7	4,76	12,7		1,4	SEKR 1204AFSN-BM						●					FMH45A MMH45A	
 N = 4	12,7	4,76	12,7	5,5		SEHT 1204AFEN					●						FMH45B MMH45B	
	12,7	4,76	12,7	5,5		SEKT 1204AFSN	●	●		●	●						FMH45B MMH45B	
 N = 4	12,7	4,76	12,7	5,5		SEKW 1204AFEN						●	●				FMH45B MMH45B	
	12,7	4,76	12,7	5,5		SEKW 1204AFSN	●	●	●	●	●			●			FMH45B MMH45B	
 N = 4	12,7	4,76	12,7			SNKN 1204ENN					●							
 N = 4	12,7	4,76	12,7		1,2	SNMN 120412					●							
 N = 4	12,7	3,18	12,7			SPAN 1203EDSR				●	●						MMP75	
	12,7	3,18	12,7			SPKN 1203EDER							●				MMP75	
	12,7	3,18	12,7			SPKN 1203EDSR	●	●	●	●	●			●			MMP75	
	15,88	4,76	15,88			SPKN 1504EDSR		●	●		●						MMP75	

Bestellbeispiel Order example: 10 Stk off SEKR 1203AFSN LC240T

● Verfügbar ab Lager Available from stock
○ Auf Anfrage On request

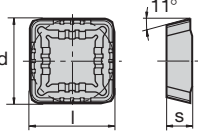
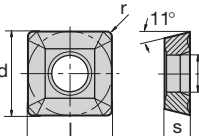
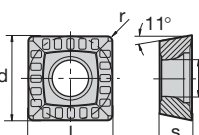
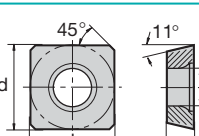
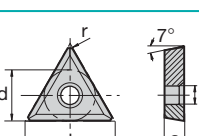
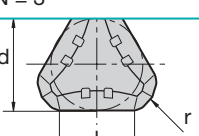
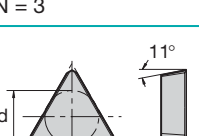
N = Anzahl der Schneidkanten N = Number of cutting edges							ISO-Code	Schneidstoffsorten Cutting materials										Für Fräser For cutter Cat-No.	
	l	s	d	d ₁	b/r			LC240T	LC230F	LC225T	LC225S	LW225	LC440T	LC444W	LC610E	LC610T	LC610A		LW610
 N = 4	12,7	3,18	12,7				SPKR 1203EDSR	●	●		●								MMP75
 N = 4	6,35 12,7	3,18 4,76	6,35 12,7	3,4 5,2	0,4 0,8		SPMT 060304 SPMT 120408SN		●	○		●							EFZ45
 N = 4	12,7	4,76	12,7	5,2	0,8		SPMT 120408SN-BP	●	○	●									EFZ45
 N = 4	12,7	4,76	12,7	5,2	0,8		SPMW 120408	●	●	●	●	●			●				EFZ45
 N = 3	11 16,5	2,4 3,97	6,35 9,52	2,8 4,3	0,2 0,4		TCMT 110202 TCMT 16T304				●	●			●				EFZ45T11 EFZ60T11 EFZ30T16 EFZ45T16 EFZ60T16
 N = 3	12	4,76	12,7		2		TNHF 1204ANEN								●				
 N = 3	16,5 16,5 22 22	3,18 3,18 4,76 4,76	9,52 9,52 12,7 12,7				TPKN 1603PDER TPKN 1603PDSR TPKN 2204PDER TPKN 2204PDSR	●	●	●	●	●			●				MMP90

Bestellbeispiel Order example: 10 Stk off SPKR 1203EDSR LC230F

● Verfügbar ab Lager
Available from stock

○ Auf Anfrage
On request

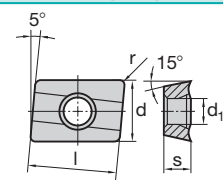
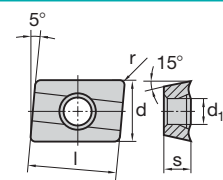
N = Anzahl der Schneidkanten N = Number of cutting edges						ISO-Code Cat-No.	Schneidstoffsorten Cutting materials Ident No.											Für Fräser For cutter Cat-No.						
	l	s	d	d ₁	b/r		LC240T	LC240S	LC230F	LC225T	LC225S	LC630T	LW240	LW225	LC440T	LC444W	LC610E		LC610T	LC610W	LC610A	LW610	LC603Z	
 <p>N = 2</p>	9,52	2,87	6,35	2,8	0,4	ADHX 090304 ER 1196-80	1069401	1069453	1068001		1069443		1069451	1069441	1067540			1069486			1069442	1069485	EMU90 ERU90	
	9,52	2,87	6,35	2,8	0,8	ADHX 090308 ER 1196-80 R03					1960082			1960081							1960080			
	9,52	2,87	6,35	2,8	1,5	ADHX 090315 ER 1196-80 R06					1960085			1960084							1960083			
	9,52	2,87	6,35	2,8	0,4	ADMX 090304 ER 1196-81	1069522	1069382			1069454		1069381	1069450				1069490			1069452			
	11,1	3,18	7,94	3,4	0,5	ADHX 110305 ER 1196-82	1069402	1069459	1068002		1069446		1069457	1069444	1067541			1069490			1069445	1069487	EMU90 ERU90	
	11,1	3,18	7,94	3,4	0,8	ADHX 110308 ER 1196-82 R03					1960072			1960071							1960070			
	11,1	3,18	7,94	3,4	1,5	ADHX 110315 ER 1196-82 R06					1960075			1960074							1960073			
	11,1	3,18	7,94	3,4	0,5	ADMX 110305 ER 1196-83	1069528	1069384			1069387		1069383	1069456				1069529			1069485			
 <p>N = 2</p>	12,7	3,97	9,52	4	0,6	ADHX 12T306 ER 1196-84	1069403	1069463	1068003		1069449		1069461	1069447	1067542			1069492			1069448	1069489	ERU90 FMU90 FRU90	
	12,7	3,97	9,52	4	1,5	ADHX 12T315 ER 1196-84 R06					1960092			1960091										
	12,7	3,97	9,52	4	2,3	ADHX 12T323 ER 1196-84 R09					1960095			1960094										
	12,7	3,97	9,52	4	0,6	ADMX 12T306 ER 1196-85	1069526	1069386			1069468		1069385	1069462				1069530			1069466			

Sortenbeschreibung/-bezeichnung und ISO-Code ab Seite 22
Description/Designation of grades and ISO-Code starting page 22

N = Anzahl der Schneidkanten N = Number of cutting edges							Schneidstoffsorten Cutting materials Ident No.											Für Fräser For cutter Cat-No.								
	l	s	d	d ₁	b/r	ISO-Code Cat-No.	LC240T	LC240S	LC230F	LC225T	LC225S	LC630T	LW240	LW225	LC440T	LC444W	LC610E		LC610T	LC610W	LC610A	LW610	LC603Z			
	12,7	3,97	9,52	4	0,6	ADHX 12T306SR-BM										1067535								ERU90 FMU90 FRU90		
	9,52	2,87	6,35	2,8	0,4	ADKX0903PESR-BP 1196-87	1055004		1058013		1055002		1055003	1055001										EMU90 ERU90		
	11,1	3,18	7,94	3,4	0,5	ADKX1103PESR-BP 1196-88	1055010		1058014		1055008		1055009	1055007												
	12,7	3,97	9,52	4	0,6	ADKX12T3PE 1196-89	1055016		1058015		1055014		1055015	1055013											ERU90 FMU90 FRU90	
	9,52	2,87	6,35	2,8	0,4	ADHX090304FR-ALC 1196-80 ALC																		EMU90 ERU90		
	11,1	3,18	7,94	3,4	0,5	ADHX110305FR-ALC 1196-82 ALC																				
	12,7	3,97	9,52	4	0,6	ADHX12T306FR-ALC 1196-84 ALC																			ERU90 FMU90 FRU90	
	15,88	4,76	12,7	5,2	0,8	1196-79		1069146			1069145		1069136	1069135												
N = 2 s = ± 0,015 l = ± 0,015 d = ± 0,02																										
	12,7	3,18	9,52	4	0,8	ADHW 120308 R 1196-02		1069440			1069153		1069151	1069142											FRP90	
N = 2																										

Sortenbeschreibung/-bezeichnung und ISO-Code ab Seite 22
Description/Designation of grades and ISO-Code starting page 22

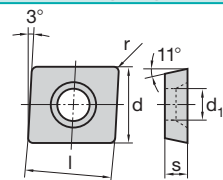
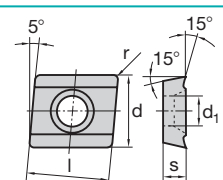
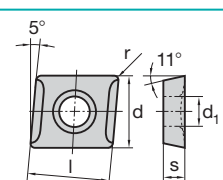
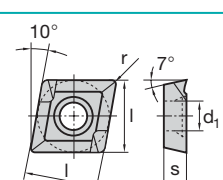
N = Anzahl der Schneidkanten N = Number of cutting edges						ISO-Code Cat-No.	Schneidstoffsorten Cutting materials Ident No.											Für Fräser For cutter Cat-No.									
	l	s	d	d ₁	b/r		LC240T	LC240S	LC230F	LC225T	LC225S	LC630T	LW240	LW225	LC440T	LC444W	LC610E		LC610T	LC610W	LC610A	LW610	LC603Z				
 <p>N = 2 s = ± 0,02 l = ± 0,015 d = ± 0,015</p>	12,7	3,97	9,52	4	0,8	1196-65	1069132	1069435																			
	15,88	4,76	12,7	5,2	0,8	1196-78	1069134	1069436			1069431		1069430	1069427							1069409						
 <p>N = 2</p>	12,7	3,18	9,52	4	0,8	ADMT 120308 R 1196-04							1069197												1069188		
	 <p>N = 2 s = ± 0,02 l = ± 0,01 d = ± 0,01</p>	12,7	3,97	9,52	3,9	0,8	1196-75		1069433		1069418		1069422	1069417											1069421		
15,88		4,76	12,7	5,2	0,8	1196-76	1069434			1069335		1069424	1069423											1069425		1069421	
 <p>N = 2 s = ± 0,025 d = ± 0,01</p>	7,94	2,78		3,4	0,3	CCHX 080203 1196-44				1069332			1069330													ESP90	
	9,52	3,18		4,4	0,4	CCHX 090304 1196-54				1069338			1069395												1069390		ESP90
	12,7	3,97		5,5	0,5	CCHX 12T305 1196-64				1069334			1069405											1069399		ESP90	

Sortenbeschreibung/-bezeichnung und ISO-Code ab Seite 22
Description/Designation of grades and ISO-Code starting page 22

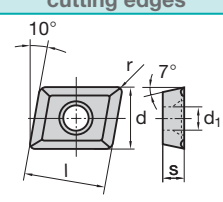
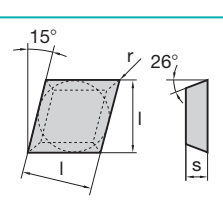
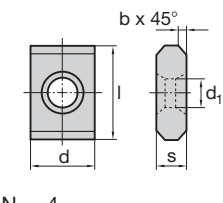
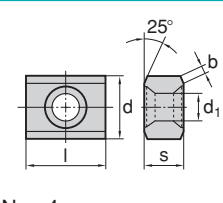
N = Anzahl der Schneidkanten N = Number of cutting edges							ISO-Code Cat-No.	Schneidstoffsorten Cutting materials Ident No.											Für Fräser For cutter Cat-No.						
	l	s	d	d ₁	b/r			LC240T	LC240S	LC230F	LC225T	LC225S	LC630T	LW240	LW225	LC440T	LC444W	LC610E		LC610T	LC610W	LC610A	LW610	LC603Z	
 <p>N = 2 s = ± 0,025 l = ± 0,01 d = ± 0,01</p>	14,3	3,97	9,52	4,4	0,5	1196-74					1069335			1069415											ESP90
 <p>N = 2</p>	12,7	3,18			0,4	EOHN 120304 1196-14 für Alu for Alu																1069240			
 <p>N = 4</p>	12,7	6,35	14,3	5,5	0,78	LNHX 1206 1185-11	2127693			2340217	2127688		1063104	1063102				2346055				1063111		2667 2695	
	19,05	6,35	14,3	5,5	0,78	LNHX 1906 1185-31			2306819	2127682			1063148	1063148				2346241				1063139			
	25,4	5	14,3	5,5	1,1	LNHX 2505 1185-32			4029351	2303419			2214362	2214362							4024397				
 <p>N = 4</p>	15,88	7,94	12,7	5,4	1,65	LNHX 1207 1185-15			2308646	1063115			2219236	2219236			1063118				1063116		2667 2695		

Sortenbeschreibung/-bezeichnung und ISO-Code ab Seite 22
Description/Designation of grades and ISO-Code starting page 22

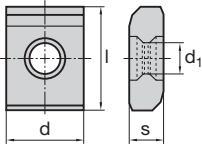
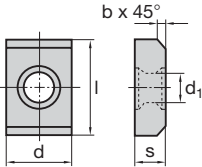
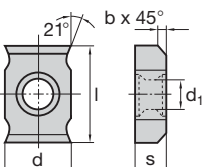
N = Anzahl der Schneidkanten N = Number of cutting edges						ISO-Code Cat-No.	Schneidstoffsorten Cutting materials Ident No.											Für Fräser For cutter Cat-No.							
	l	s	d	d ₁	b/r		LC240T	LC240S	LC230F	LC225T	LC225S	LC630T	LW240	LW225	LC440T	LC444W	LC610E		LC610T	LC610W	LC610A	LW610	LC603Z		
 N = 4	19,05	6,35	14,3	5,8		LNHX 1906 1185-35				1063136	1063135												2667 2695		
	25,4	5	14,3	5,5		LNHX 2505 1185-33				2345789	2306829			2289399											
 N = 4	15,88	4,15	9,52	4,5	1	LNHX 1504 1185-20																			
	14,29	2,8	11,11	4,5	0,25	LNHX 1402 1185-50				1061285				1061284										SMN90	
	14,29	3,3	11,11	4,5	0,3	LNHX 1403 1185-51				1061286	2275464			1061300											
	14,29	4,3	11,11	4,5	0,4	LNHX 1404 1185-52				1061287	2275582			1061328											
	14,29	5,3	11,11	4,5	0,5	LNHX 1405 1185-53				1061288				1061346											
	14,29	6,35	12,7	5,5	0,6	LNHX 1406 1185-54				1061289				1061364											
 N = 4	15,88	4,15	9,52	4,5	1	LNHX 1504 1185-21					2307079			1062844										SMN90	
	14,29	2,8	11,11	4,5	0,25	LNHX 1402 1185-55				1061297				1061382											
	14,29	3,3	11,11	4,5	0,3	LNHX 1403 1185-56				1061290	1061296			1061408											

Sortenbeschreibung/-bezeichnung und ISO-Code ab Seite 22
Description/Designation of grades and ISO-Code starting page 22

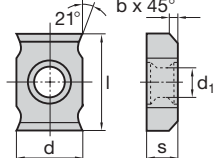
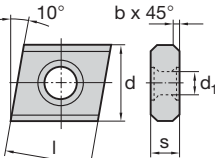
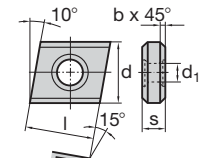
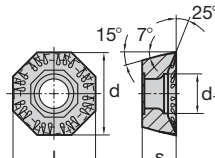
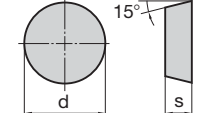
N = Anzahl der Schneidkanten N = Number of cutting edges						ISO-Code Cat-No.	Schneidstoffsorten Cutting materials Ident No.										Für Fräser For cutter Cat-No.							
	l	s	d	d ₁	b/r		LC240T	LC240S	LC230F	LC225T	LC225S	LC630T	LW240	LW225	LC440T	LC444W		LC610E	LC610T	LC610W	LC610A	LW610	LC603Z	
 N = 4	14,29	4,3	11,11	4,5	0,4	LNHX 1404 1185-57				1061291	1061295		1061426								1061417		SMN90	
	14,29	5,3	11,11	4,5	0,5	LNHX 1405 1185-58				1061292			1061444								1061435			
	14,29	6,35	12,7	5,5	0,6	LNHX 1406 1185-59				1061294			1061471								1061462			
 N = 4 s = ± 0,01 l = ± 0,015 d = ± 0,01	11,1	5,3	8	4,5	0,3	1186-21					1052206										1052207			
	11,1	5,3	9	4,5	0,3	1186-31					1052216		1052213								1052215			
	11,1	5,3	10	4,5	0,3	1186-41				1052224		1052221									1052223			
 N = 4 s = ± 0,01 l = ± 0,015 d = ± 0,01	11,1	5,3	8	4,5	0,3	1186-25					1052210		1052209								1052211			
	11,1	5,3	9	4,5	0,3	1186-35					1052220		1052217									1052219		
	11,1	5,3	10	4,5	0,3	1186-45				1052226		1052225										1052227		
 N = 8	16	6,35	16	5,8	0,5	OCKX 0606 AD-TR	1054003		1068004	1054001	1054002	1054000											FCT45 FCTXX MCT45	
	16	6,35	16	5,8	0,5	OCKX 0606 AD-TRT breite Schneidkantenfase wide land	1055731 ¹⁾			1054012						1055011								
		3,18	14			RDHN 1403 MO 1194-21				1068608	1068036	1068027									1068018			

¹⁾ LC280TT Schruppgeometrie mit 2-fach Beschichtung
Roughing geometry with double coating

Sortenbeschreibung/-bezeichnung und ISO-Code ab Seite 22
Description/Designation of grades and ISO-Code starting page 22

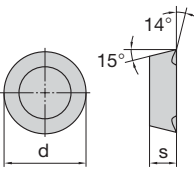
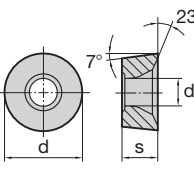
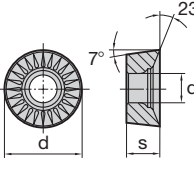
N = Anzahl der Schneidkanten N = Number of cutting edges						ISO-Code Cat-No.	Schneidstoffsorten Cutting materials Ident No.											Für Fräser For cutter Cat-No.						
	l	s	d	d ₁	b/r		LC240T	LC240S	LC230F	LC225T	LC225S	LC630T	LW240	LW225	LC440T	LC444W	LC610E		LC610T	LC610W	LC610A	LW610	LC603Z	
		3,18	14			RDHR 1403 MO 1194-22							1068116							1068107				
		1,98	5	2,1		RCHX 05T1 MO 1195-02	1055635			1068396			1055634	1055612			1055639			1055625	1055750		ECT	
		2,78	7	2,8		RCHX 0702 MO 1195-07	1068443			1068441			1068442	1068440			1068445			1068444	1055751	1055752		
		3,18	8	3,4		RCHX 0803 MO 1195-03	1068387	1068378			1068376			1068372	1068370			1068391			1068374	1055752		
		3,97	10	4,4		RCHX 10T3 MO 1195-04	1068393	1068388			1068386			1068382	1068380			1068395			1068384	1055753		ECT FCT
		5,56	12	5,2		RCHX 1205 MO 1195-13	1068375	1068406			1068405			1068403	1068402			1068377			1068404	1055754		
		6,35	16	5,8		RCHX 1606 MO 1195-14	1068379	1068415			1068414			1068411	1068407			1068383			1068413	1055755		ECT FCT MCT
		5,56	12	5,2		RCHX 1205 MO-TR 1195-13 TR	1069519	1069517		1069515			1069513	1069512			1069520			1069514			ECT FCT	
		6,35	12	5,2		RCHX 1606 MO-TR 1195-14 TR	1069506		1069501	1069503			1069505	1069502			1069509			1069508	1069504			ECT FCT MCT

Sortenbeschreibung/-bezeichnung und ISO-Code ab Seite 22
Description/Designation of grades and ISO-Code starting page 22

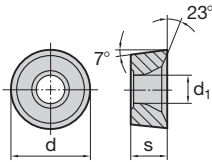
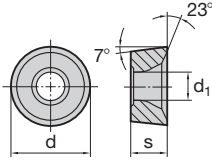
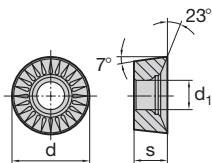
N = Anzahl der Schneidkanten N = Number of cutting edges						ISO-Code Cat-No.	Schneidstoffsorten Cutting materials Ident No.											Für Fräser For cutter Cat-No.						
	l	s	d	d ₁	b/r		LC240T	LC240S	LC230F	LC225T	LC225S	LC630T	LW240	LW225	LC440T	LC444W	LC610E		LC610T	LC610W	LC610A	LW610	LC603Z	
 <p>breite Schneidkantenfase wide land</p>	3,18	8	3,4			RCHX 0803 MO-T 1195-03 T											1068397						ECT	
	3,97	10	4,4			RCHX 10T3 MO-T 1195-04 T											1068398						ECT FCT	
	5,56	12	5,2			RCHX 1205 MO-T 1195-13 T											1068399							
	5,56	16	5,8			RCHX 1205 MO-T 1195-23	1068395	1068409			1068408		1068392	1068390							1068394			
	6,35	16	5,8			RCHX 1606 MO-T 1195-24	1068389	1068417			1068416		1068420	1068419				2345947			1068421			ECT FCT MCT
	5,56	12	5,2			RCMX 1205 MO-T 1195-27	1068425				1068423		1068424	1068422										ECT FCT
	6,35	16	5,8			RCMX 1606 MO-T 1195-28	1068429				1068427		1068428	1068426										ECT FCT MCT
 <p>breite Schneidkantenfase wide land</p>	3,18	8	3,4			RCKT 0803 MO-TT																	ECT	
	3,97	10	4,4			RCKT 10T3 MO-TT																		ECT FCT
	5,56	12	5,2			RCKT 1205 MO-TT																	ECT FCT	
	6,35	16	5,8			RCKT 1606 MO-TT																		ECT FCT MCT

¹⁾ LC280TT Schruppgeometrie mit 2-fach Beschichtung
Roughing geometry with double coating

Sortenbeschreibung/-bezeichnung und ISO-Code ab Seite 22
Description/Designation of grades and ISO-Code starting page 22

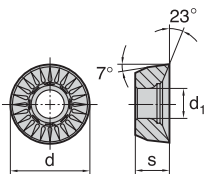
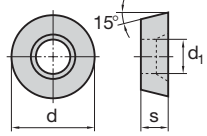
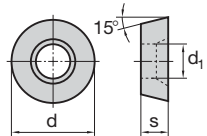
N = Anzahl der Schneidkanten N = Number of cutting edges						ISO-Code Cat-No.	Schneidstoffsorten Cutting materials Ident No.											Für Fräser For cutter Cat-No.							
	l	s	d	d ₁	b/r		LC240T	LC240S	LC230F	LC225T	LC225S	LC630T	LW240	LW225	LC440T	LC444W	LC610E		LC610T	LC610W	LC610A	LW610	LC603Z		
 N = 2	6,35	16	5,8			RCKX 1606 MO-TR	1068433																	FCT45 FCTXX MCT45	
	6,35	16	5,8			RCKX 1606 MO-TRT breite Schneidkantenfase wide land	1055730 ¹⁾				1068460						1068435					1068434			
	2,38	7,6	2,8			RDHX 0702 MO 1195-11	1068607	1068607	1070024																
	2,78	9,6	3,8			RDHX 0902 MO 1195-21	1068609	1068609	1070025																
	3,97	11,6	5			RDHX 11T3 MO 1195-31	1068610	1068610	1070026																
	4,76	15,6	5,2			RDHX 1504 MO 1195-41	1068611	1068611	1070027																
	1,5	5	2			RDHX 0501 MO 1195-01	1055505	1055505	1068369																ECZ
	2,38	7	2,7			RDHX 0702 MO 1195-09	1055617	1055617	1055616																
	2,38	8	2,8			RDHW 0802 MO 1195-15	1068612	1068612	1070129																ECZ
	3,18	10	3,8			RDHW 1003 MO 1195-25	1068613	1068613	1070137																
	3,97	12	5			RDHW 12T3 MO 1195-35	1068614	1068614	1070147																ECZ FCZ
	3,97	12	3,8			RDHX 12T3 MO 1195-36	1070156	1070156	1070156																
	4,76	16	5,2			RDHW 1604 MO 1195-45	1068616	1070167																	
								1070165																	

¹⁾ LC280TT Schruppgeometrie mit 2-fach Beschichtung
Roughing geometry with double coating

Sortenbeschreibung/-bezeichnung und ISO-Code ab Seite 22
Description/Designation of grades and ISO-Code starting page 22

N = Anzahl der Schneidkanten N = Number of cutting edges						ISO-Code Cat-No.	Schneidstoffsorten Cutting materials Ident No.											Für Fräser For cutter Cat-No.						
	l	s	d	d ₁	b/r		LC240T	LC240S	LC230F	LC225T	LC225S	LC630T	LW240	LW225	LC440T	LC444W	LC610E		LC610T	LC610W	LC610A	LW610	LC603Z	
	2,38	7,6	2,8			RDHX 0702 MO 1195-12																		
	2,87	9,6	3,8			RDHX 0902 MO 1195-22																		
	3,97	11,6	5			RDHX 11T3 MO 1195-32																1068465		
	4,76	15,6	5,2			RDHX 1504 MO 1195-42							1068492									1068483	1068465	
	2,38	7	2,7			RDKT 0702 MO-TT																		ECZ
	2,38	8	2,8			RDKT 0802 MO-TT																		
	3,18	10	3,8			RDKT 1003 MO-TT																		
	3,18	10	3,8			RDKT 1003 MO							1070170					1070173					1070172	
	3,97	12	5			RDKT 12T3 MO-TT																		ECZ FCZ
	3,97	12	3,8			RDKX 12T3 MO-TT																		
	3,97	12	3,8			RDKX 12T3 MO							1070176					1070179					1070178	
	4,76	16	5,2			RDKT 1604 MO-TT																		
	4,76	16	5,2			RDKT 1604 MO							1070180					1070183					1070182	

¹⁾ **LC280TT** Schruppgeometrie mit 2-fach Beschichtung
Roughing geometry with double coating

Sortenbeschreibung/-bezeichnung und ISO-Code ab Seite 22
Description/Designation of grades and ISO-Code starting page 22

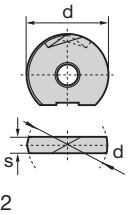
N = Anzahl der Schneidkanten N = Number of cutting edges						ISO-Code Cat-No.	Schneidstoffsorten Cutting materials Ident No.												Für Fräser For cutter Cat-No.						
	l	s	d	d ₁	r		LC225N	LC240N	LC240T	LC240S	LC230F	LC225T	LC225S	LC630T	LW240	LW225	LC440T	LC444W		LC610E	LC610T	LC610W	LC610A	LW610	LC603Z
			2	8				WPR 08-N																	
		2,5	10			WPR 10-N	K123158	K123050	K127908						K123058					K123048	K123049		K123047		
		2,5	12			WPR 12-N	K123139	K123138	K282696						K123159	K123162				K123154	K123137		K123153		
		3	16			WPR 16-N	K123121	K123120	K127665						K123140	K123144				K123136	K123119		K123135		
		3	20			WPR 20-N	K123108	K123107	K127911						K123122	K123126				K123118	K123106		K123117		
		4	25			WPR 25-N	K123085	K123084	K128448						K180175	K123104				K123100	K123083		K123099		
		5	30			WPR 30-N	K122679	K123072	K282697						K123065					K122678	K200390		K200388		
		5	32			WPR 32-N	K123080	K127953	K127562						K180254	K123090				K123077	K123078		K123076		

Alle WPR-, WPV- und WPB-Wendeplatten sind in der Sorte LC 610A (diamantbeschichtet) oder PKD/CBN-bestückt auf Anfrage lieferbar
All WPR, WPV and WPP inserts are available in grade LC 610A (diamond coated) or PCD/CBN tipped

Sortenbeschreibung/-bezeichnung und ISO-Code ab Seite 22
Description/Designation of grades and ISO-Code starting page 22

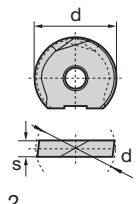
N = Anzahl der Schneidkanten N = Number of cutting edges						ISO-Code Cat-No.	Schneidstoffsorten Cutting materials Ident No.												Für Fräser For cutter Cat-No.								
	l	s	d	d ₁	r		LC225N	LC240N	LC240T	LC240S	LC230F	LC225T	LC225S	LC630T	LW240	LW225	LC440T	LC444W		LC610E	LC610T	LC610W	LC610A	LW610	LC603Z		
 <p>N = 2</p>		2	8			WPR 08-CF																				EBG R (GWR)	
		2,5	10			WPR 10-CF	K123038	K123046	K282700											K122964	K122949						
		2,5	12			WPR 12-CF	K123028	K123027	K282703											K123044	K123045						
		3	16			WPR 16-CF	K123010	K123009	K282705											K123007	K123008						
		3	20			WPR 20-CF	K122992	K122991	K282709											K123005	K122990						
		4	25			WPR 25-CF	K122988	K122987	K128868											K122985	K122986						
		5	30			WPR 30-CF		K122967	K282712											K200286	K122966						
		5	32			WPR 32-CF	K122971	K122970	K282714											K122980	K122981						

CF = Spanleitstufe für langspanende Eisenwerkstoffe
 CF = Chip Control Geometry for longchipping ferrous materials
 Alle WPR-, WPV- und WPB-Wendeplatten sind in der Sorte LC 610A (diamantbeschichtet) oder PKD/CBN-bestückt auf Anfrage lieferbar
 All WPR, WPV and WPP inserts are available in grade LC 610A (diamond coated) or PCD/CBN tipped

Sortenbeschreibung/-bezeichnung und ISO-Code ab Seite 22
 Description/Designation of grades and ISO-Code starting page 22

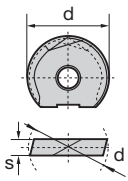
						Schneidstoffsorten Cutting materials											Für Fräser For cutter						
						Ident No.																	
N = Anzahl der Schneidkanten N = Number of cutting edges	l	s	d	d ₁	r	ISO-Code Cat-No.	LC240T	LC240S	LC230F	LC225T	LC225S	LC630T	LW240	LW225	LC440T	LC444W		LC610E	LC610T	LC610W	LC610A	LW610	LC603Z
 N = 2		2	8			WPR 08-CN												K200289	K122915			K122914	
		2,5	10			WPR 10-CN												K200292	K122954			K122953	
		2,5	12			WPR 12-CN												K200293	K122948			K122947	
		3	16			WPR 16-CN												K200294	K122934			K122933	
		3	20			WPR 20-CN												K200295	K122940			K122939	
		4	25			WPR 25-CN												K200296	K122929			K122928	
		5	30			WPR 30-CN												K122924	K122916			K122923	
		5	32			WPR 32-CN												K282722	K122918			K122917	

CN = Spanleitstufe für Nichteisenmetalle, Kunststoffe und Graphit
 CN = Chip Control Geometry for non-ferrous materials, plastics and graphite
 Alle WPR-, WPV- und WPB-Wendeplatten sind in der Sorte LC 610A
 (diamantbeschichtet) oder PKD/CBN-bestückt auf Anfrage lieferbar
 All WPR, WPV and WPP inserts are available in grade LC 610A
 (diamond coated) or PCD/CBN tipped

Sortenbeschreibung/-bezeichnung und ISO-Code ab Seite 22
 Description/Designation of grades and ISO-Code starting page 22

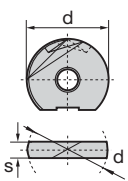
N = Anzahl der Schneidkanten N = Number of cutting edges						ISO-Code Cat-No.	Schneidstoffsorten Cutting materials Ident No.											Für Fräser For cutter Cat-No.				
	l	s	d	d ₁	r		LC240T	LC240S	LC230F	LC225T	LC225S	LC630T	LW240	LW225	LC440T	LC444W	LC610E		LC610T	LC610W	LC610A	LW610
 <p>N = 2</p>		1,6	6			WPR 06-F											K128480		K282818			EBG R (GWR)
		2	8			WPR 08-F											K128802		K282819			
		2,5	10			WPR 10-F											K128803		K282820			
		2,5	12			WPR 12-F											K128804		K282821			
		3	16			WPR 16-F											K128805		K282822			
		3	20			WPR 20-F											K128806		K282823			
		4	25			WPR 25-F											K128807					
		5	30			WPR 30-F											K282723					
		5	32			WPR 32-F											K282724					

F = Spanleitstufe für Feinbearbeitung
 F = Chip Control Geometry for finishing
 Alle WPR-, WPV- und WPB-Wendeplatten sind in der Sorte LC 610A
 (diamantbeschichtet) oder PKD/CBN-bestückt auf Anfrage lieferbar
 All WPR, WPV and WPP inserts are available in grade LC 610A
 (diamond coated) or PCD/CBN tipped

Sortenbeschreibung/-bezeichnung und ISO-Code ab Seite 22
 Description/Designation of grades and ISO-Code starting page 22

N = Anzahl der Schneidkanten N = Number of cutting edges						ISO-Code Cat-No.	Schneidstoffsorten Cutting materials Ident No.											Für Fräser For cutter Cat-No.									
	l	s	d	d ₁	r		LC225N	LC240N	LC240T	LC240S	LC230F	LC225T	LC225S	LC630T	LW240	LW225	LC440T		LC444W	LC610E	LC610T	LC610W	LC610A	LW610	LC603Z		
<p>N = 2</p>	9,5	2	8		0,6	WPV 08-N		K122597	K127913										K122595	K122596					K122594	EBG V (GWV)	
	11,5	2,5	10		0,8	WPV 10-N		K122671	K127912										K122669	K122670					K122668		
	14	2,5	12		1,0	WPV 12-N		K122649	K127331										K122665	K122648					K122664		
	16	3	16		1,3	WPV 16-N		K122643	K127310											K122641	K122642						K122640
	18	3	20		1,6	WPV 20-N		K122637	K127657											K122635	K122636						K122634
	23,5	4	25		2,0	WPV 25-N		K122613	K127914											K122629	K122612						K122628
	28	5	32		2,5	WPV 32-N		K122607	K127656											K122605	K122606						K122620

Alle WPR-, WPV- und WPB-Wendeplatten sind in der Sorte LC 610A (diamantbeschichtet) oder PKD/CBN-bestückt auf Anfrage lieferbar
All WPR, WPV and WPP inserts are available in grade LC 610A (diamond coated) or PCD/CBN tipped

Sortenbeschreibung/-bezeichnung und ISO-Code ab Seite 22
Description/Designation of grades and ISO-Code starting page 22

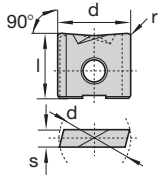
N = Anzahl der Schneidkanten N = Number of cutting edges							Schneidstoffsorten Cutting materials Ident No.													Für Fräser For cutter								
	l	s	d	d ₁	r	ISO-Code Cat-No.	LC225N	LC240N	LC240T	LC240S	LC230F	LC225T	LC225S	LC630T	LW240	LW225	LC440T	LC444W	LC610E	LC610T	LC610W	LC610A	LW610	LC603Z	Cat-No.			
 N = 2	9,5	2	8		0,6	WPV 08-N-CF		K122537	K282725						K122538											EBG V (GWV)		
	11,5	2,5	10		0,8	WPV 10-N-CF		K122589	K282727						K122598													
	14	2,5	12		1,0	WPV 12-N-CF		K122582	K282729						K122590													
	16	3	16		1,3	WPV 16-N-CF		K122575	K282731						K122583													
	18	3	20		1,6	WPV 20-N-CF		K122568	K282733						K122576													
	23,5	4	25		2,0	WPV 25-N-CF		K122561	K282735						K122569													
	28	5	32		2,5	WPV 32-N-CF		K122553	K282737						K122546													

CF = Spanleitstufe für langspanende Eisenwerkstoffe
 CF = Chip Control Geometry for longchipping ferrous materials
 Alle WPR-, WPV- und WPB-Wendeplatten sind in der Sorte LC 610A (diamantbeschichtet) oder PKD/CBN-bestückt auf Anfrage lieferbar
 All WPR, WPV and WPP inserts are available in grade LC 610A (diamond coated) or PCD/CBN tipped

Sortenbeschreibung/-bezeichnung und ISO-Code ab Seite 22
 Description/Designation of grades and ISO-Code starting page 22

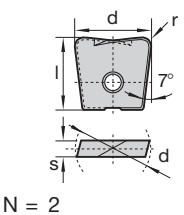
N = Anzahl der Schneidkanten N = Number of cutting edges						ISO-Code Cat-No.	Schneidstoffsorten Cutting materials Ident No.											Für Fräser For cutter Cat-No.					
	l	s	d	d ₁	r		LC240T	LC240S	LC230F	LC225T	LC225S	LC630T	LW240	LW225	LC440T	LC444W	LC610E		LC610T	LC610W	LC610A	LW610	LC603Z
 <p>N = 2</p>	9,5	2	8		0,6	WPB 08-N-06											K282927					K282921	EBG V (GWV)
	9,5	2	8		1,0	WPB 08-N-10											K282919					K282916	
	11,5	2,5	10		0,8	WPB 10-N-08											K282928					K282922	
	11,5	2,5	10		1,0	WPB 10-N-10											K282918					K282917	
	14	2,5	12		1,0	WPB 12-N-10											K129227					K129226	
	14	2,5	12		2,0	WPB 12-N-20											K128106					K128105	
	16	3	16		1,0	WPB 16-N-10											K129229					K129228	
	16	3	16		1,3	WPB 16-N-13											K282931					K282923	
	16	3	16		3,0	WPB 16-N-30											K128110					K128109	

Alle WPR-, WPV- und WPB-Wendeplatten sind in der Sorte LC 610A (diamantbeschichtet) oder PKD/CBN-bestückt auf Anfrage lieferbar
All WPR, WPV and WPP inserts are available in grade LC 610A (diamond coated) or PCD/CBN tipped

Sortenbeschreibung/-bezeichnung und ISO-Code ab Seite 22
Description/Designation of grades and ISO-Code starting page 22

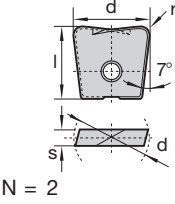
N = Anzahl der Schneidkanten N = Number of cutting edges						ISO-Code Cat-No.	Schneidstoffsorten Cutting materials Ident No.											Für Fräser For cutter Cat-No.						
	l	s	d	d ₁	r		LC240T	LC240S	LC230F	LC225T	LC225S	LC630T	LW240	LW225	LC440T	LC444W	LC610E		LC610T	LC610W	LC610A	LW610	LC603Z	
 <p>N = 2</p>	18	3	20		1,0	WPB 20-N-10												K129231				K129230		EBG (GWV)
	18	3	20		1,6	WPB 20-N-16												K282930				K282924		
	18	3	20		4,0	WPB 20-N-40												K128114				K128113		
	23,5	4	25		1,0	WPB 25-N-10												K129233				K129232		
	23,5	4	25		2,0	WPB 25-N-20												K282929				K282926		
	23,5	4	25		5,0	WPB 25-N-50												K128118				K128117		

Alle WPR-, WPV- und WPB-Wendeplatten sind in der Sorte LC 610A (diamantbeschichtet) oder PKD/CBN-bestückt auf Anfrage lieferbar
All WPR, WPV and WPP inserts are available in grade LC 610A (diamond coated) or PCD/CBN tipped

Sortenbeschreibung/-bezeichnung und ISO-Code ab Seite 22
Description/Designation of grades and ISO-Code starting page 22

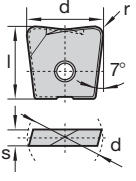
N = Anzahl der Schneidkanten N = Number of cutting edges						ISO-Code Cat-No.	Schneidstoffsorten Cutting materials Ident No.											Für Fräser For cutter Cat-No.							
	l	s	d	d ₁	r		LC240T	LC240S	LC230F	LC225T	LC225S	LC630T	LW240	LW225	LC440T	LC444W	LC610E		LC610T	LC610W	LC610A	LW610	LC603Z		
 N = 2	8	1,6	6		0,5	WPB 06-N-05-CF											K129235		K282824	K129234					
	9,5	2	8		1,0	WPB 08-N-10-CF											K129237		K282825	K129236					
	11,5	2,5	10		1,0	WPB 10-N-10-CF											K129239		K282826	K129238					
	14	2,5	12		1,0	WPB 12-N-10-CF											K282913		K282827	K282909					
	14	2,5	12		2,0	WPB 12-N-20-CF											K128108			K128107					
	16	3	16		1,0	WPB 16-N-10-CF											K282914		K282828	K282910					
	16	3	16		3,0	WPB 16-N-30-CF											K128112			K128111					
	18	3	20		1,0	WPB 20-N-10-CF											K129258			K282911					
	18	3	20		4,0	WPB 20-N-40-CF											K128116			K128115					
	23,5	4	25		1,0	WPB 25-N-10-CF											K282916			K282912					
	23,5	4	25		5,0	WPB 25-N-50-CF											K128120			K128119					

Alle WPR-, WPV- und WPB-Wendeplatten sind in der Sorte LC 610A (diamantbeschichtet) oder PKD/CBN-bestückt auf Anfrage lieferbar
All WPR, WPV and WPP inserts are available in grade LC 610A (diamond coated) or PCD/CBN tipped

Sortenbeschreibung/-bezeichnung und ISO-Code ab Seite 22
Description/Designation of grades and ISO-Code starting page 22

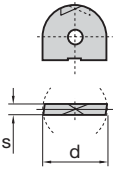
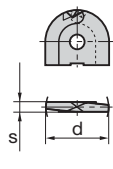
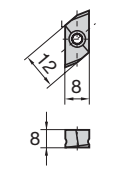
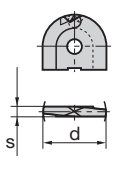
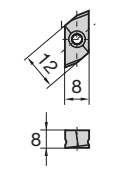
N = Anzahl der Schneidkanten N = Number of cutting edges							Schneidstoffsorten Cutting materials Ident No.												Für Fräser For cutter Cat-No.								
	l	s	d	d ₁	r	ISO-Code Cat-No.	LC225N	LC240N	LC240T	LC240S	LC230F	LC225T	LC225S	LC630T	LW240	LW225	LC440T	LC444W		LC610E	LC610T	LC610W	LC610A	LW610	LC603Z		
 N = 2		4	25			WRT 25		K122404							K200211						K122402	K122403		K122401			EBG T (GRT)
		5	32			WRT 32		K122389							K200213						K122387	K122388		K122400			
 N = 2		4	25			WRX 25		K122378							K122390						K122394	K122395		K122393			EBG T (GRT)
		5	32			WRX 32		K122385							K122379						K122383	K122384		K122382			
 N = 2	6	8	12			WPT-A		K122422							K122414						K122419	K122420		K122418			EBG T (GRT)
 N = 2		4	25			WRS 25 ¹⁾																K127533		K122407			EBG T (GRT)
		5	32			WRS 32 ¹⁾																K127329		K122409			
 N = 2	12	6				WPS-A ¹⁾																K127535		K122405			EBG T (GRT)

¹⁾ Für die Bearbeitung von Modellbauwerkstoffen

¹⁾ For machining materials in model making industry

Alle WPR-, WPV- und WPB-Wendeplatten sind in der Sorte LC 610A (diamantbeschichtet) auf Anfrage lieferbar

All WPR, WPV and WPP inserts are available in grade LC 610A (diamond coated)

Sortenbeschreibung/-bezeichnung und ISO-Code ab Seite 22

Description/Designation of grades and ISO-Code starting page 22

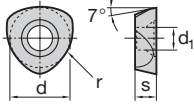
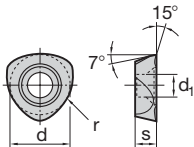
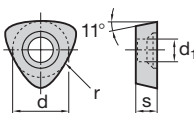
N = Anzahl der Schneidkanten N = Number of cutting edges						ISO-Code Cat-No.	Schneidstoffsorten Cutting materials Ident No.											Für Fräser For cutter Cat-No.					
	l	s	d	d ₁	b/r		LC240T	LC240S	LC230F	LC225T	LC225S	LC630T	LW240	LW225	LC440T	LC444W	LC610E		LC610T	LC610W	LC610A	LW610	LC603Z
 <p>N = 3 s = ± 0,02 d = ± 0,01</p>	2,78	9,52	3,9	6	1177-11				1058139	1058130				1058127							1058149	1058178	
	2,78	9,52	3,9	6	1177-11T	1058190 ¹⁾											1058191						ECPO5
	3,18	12,7	3,9	8	1177-31				1058153	1058138				1058136							1058148	1058179	
	3,97	15,88	5	10	1177-51				1058158	1058208				1058204							1058202	1058180	
	4,76	19,05	5,5	12,5	1177-71				1058160	1058216				1058212							1058210	1058181	
 <p>N = 3 s = ± 0,02 d = ± 0,01</p>	2,78	9,52	3,9	6	1177-16				1058162	1058167			1058159										
	3,18	12,7	3,9	8	1177-36				1058164	1058169			1058161										
	3,97	15,88	5	10	1177-56				1058166	1058171			1058163										
	4,76	19,05	5,5	12,5	1177-76				1058168	1058173			1058165										
 <p>N = 3 s = ± 0,025 d = ± 0,01</p>	3,97	9,52	3,9	12,5	1177-15	1058170	1058134			1058133		1058123	1058129								1058157		
	3,97	9,52	3,9	16	1177-25	1058172	1058135			1058094		1058124	1058092									1058460	
	3,97	9,52	3,9	20	1177-45	1058177	1058137			1058111		1058125	1058109									1058462	

¹⁾ LC280TT Schruppgeometrie mit 2-fach Beschichtung
Roughing geometry with double coating

Sortenbeschreibung/-bezeichnung und ISO-Code ab Seite 22
Description/Designation of grades and ISO-Code starting page 22

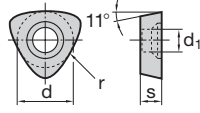
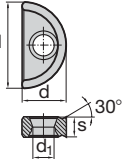
N = Anzahl der Schneidkanten N = Number of cutting edges						ISO-Code Cat-No.	Schneidstoffsorten Cutting materials Ident No.											Für Fräser For cutter Cat-No.						
	l	s	d	d ₁	b/r		LC240T	LC240S	LC230F	LC225T	LC225S	LC630T	LW240	LW225	LC440T	LC444W	LC610E		LC610T	LC610W	LC610A	LW610	LC603Z	
 N = 3 s = ± 0,025 d = ± 0,01		3,97	9,52	3,9	25	1177-65	1058174	1058126				1058120	1058119	1058118							1058465			
		3,97	9,52	3,9	25	1177-65T	1058187 ¹⁾										1058187							ECP05 FCP05
		4,76	12,7	5	31,5	1177-88	1058175	1058128				1058152	1058121	1058142										
		4,76	12,7	5,2	40	1177-98	1058176	1058132			1058155	1058122	1058144	1058142										
 N = 2 s = ± 0,01 l = ± 0,02 d = ± 0,01	15,191	3,18	7,04	3,4	8 ²⁾	1179-11	1069575	1069617		1069573	1069626	1069550	1069624				1069577				1069625			EBT R
	18,989	3,97	8,80	4,2	10 ²⁾	1179-21	1069581	1069619		1069579	1069629	1069540	1069627				1069583				1069628			
	23,736	4,76	11	5,2	12,5 ²⁾	1179-31	1069585	1069621		1069584	1069633	1069541	1069630				1069587				1069631			
	28,48	5,23	13,2	5,5	15 ²⁾	1179-40	1069641	1069557		1069559	1069556	1069554	1069553				1069642				1069555			
	30,382	5,56	14,08	5,8	16 ²⁾	1179-41	1069589	1069622		1069588	1069636		1069634				1069571				1069635			

¹⁾ LC280TT Schruppgeometrie mit 2-fach Beschichtung
Roughing geometry with double coating

²⁾ Radius am Werkstück Radius on workpiece

Sortenbeschreibung/-bezeichnung und ISO-Code ab Seite 22
Description/Designation of grades and ISO-Code starting page 22

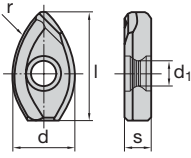
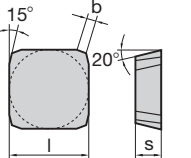
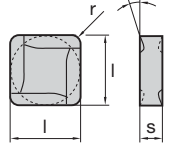
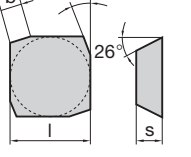
N = Anzahl der Schneidkanten N = Number of cutting edges						ISO-Code Cat-No.	Schneidstoffsorten Cutting materials Ident No.											Für Fräser For cutter Cat-No.					
	l	s	d	d ₁	b/r		LC240T	LC240S	LC230F	LC225T	LC225S	LC630T	LW240	LW225	LC440T	LC444W	LC610E		LC610T	LC610W	LC610A	LW610	LC603Z
							1069560	1069599			1069598		1069596	1069595									1069562
 <p>N = 2 s = ± 0,025 d = ± 0,01</p>	12,79	3,18	7,15	3,5	10	1179-25																	EBT X
	15,99	3,97	8,94	4,1	12,5	1179-35	1069563	1069594			1069593		1069591	1069590				1069564			1069592		
	20,47	5,08	11,44	4,5	16	1179-45	1069565	1069604			1069603		1069601	1069600				1069566			1069602		
	25,58	6,35	14,3	5,5	20	1179-55	1069567	1069610			1069609		1069607	1069606				1069568			1069608		
	21,55	6,35	14,3	5,5	25	1179-65	1069569	1069615			1069614		1069612	1069611				1069685			1069613		
 <p>N = 4</p>	12,7	3,18			1,4	SEAN 1203 EFR 1192-15				1066676											1066675		
 <p>N = 8</p>	12,7	4,76			1,2	SNEF 120412 R 1181-11				2216269										1063200	1059965		
	12,7	4,76			1,2	SNMF 120412 1181-10						1059956	1059947	1059992							1059910		
 <p>N = 4</p>	12,7	3,18			2,4	SOEN 1203 ZZR 1192-14 für Alu for Alu															1066671		

Sortenbeschreibung/-bezeichnung und ISO-Code ab Seite 22
Description/Designation of grades and ISO-Code starting page 22

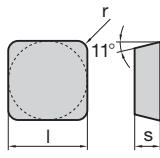
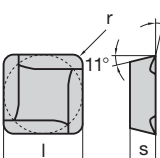
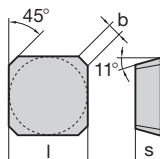
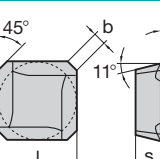
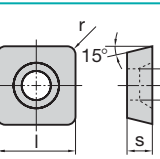
N = Anzahl der Schneidkanten N = Number of cutting edges						ISO-Code Cat-No.	Schneidstoffsorten Cutting materials Ident No.											Für Fräser For cutter Cat-No.																	
	l	s	d	d ₁	b/r		LC240T	LC240S	LC230F	LC225T	LC225S	LC630T	LW240	LW225	LC440T	LC444W	LC610E		LC610T	LC610W	LC610A	LW610	LC603Z												
 N = 4	12,7	3,18			1,2	SPEN 120312 1190-11																	2219428	1065306	1065299								1065262	1067455	MMP75
	12,7	3,18			1,2	SPEN 120312 1190-10																		1065244	1065244								1065217		
 N = 4	12,7	3,18			1,2	SPER 120312 R 1191-11																1065912	1065903	1065896								1065867	1065869	MMP75	
	12,7	3,18			1,2	SPMR 120312 R 1191-10																		1065841	1065841								1065814		
 N = 4	12,7	3,18			1,4	SPKN 1203 AE 1193-10																											1067206		
	15,88	4,76			2	SPAN 1504 AE 1193-21																	1067511	1067493	1067493								1067466	1067450	
	15,88	4,76			2	SPKN 1504 AE 1193-20																		1067488	1067488								1067411		
 N = 4	12,7	3,18			1,4	SPKX 1203 AER 1193-12																											1067279		
	15,88	4,76			2	SPAX 1504 AR 1193-31																		1067652	1067652								1067661		
	15,88	4,76			2	SPKX 1504 AER 1193-30																		1067607	1067607								1067616		
 N = 4	16	5		5,2	1	SDHX 160510 1196-21																1069438											1069277		FRP90

Sortenbeschreibung/-bezeichnung und ISO-Code ab Seite 22
Description/Designation of grades and ISO-Code starting page 22

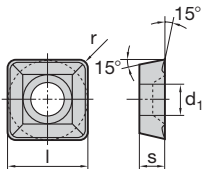
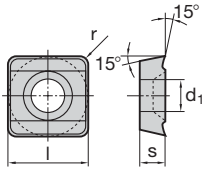
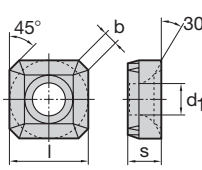
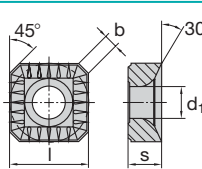
N = Anzahl der Schneidkanten N = Number of cutting edges						ISO-Code Cat-No.	Schneidstoffsorten Cutting materials Ident No.												Für Fräser For cutter Cat-No.				
	l	s	d	d ₁	b/r		LC240T	LC240S	LC230F	LC225T	LC225S	LC630T	LW240	LW225	LC440T	LC444W	LC610E	LC610T		LC610W	LC610A	LW610	LC603Z
 N = 4	16	5		5,3	1	SDMX 160510 1196-22		1069319					1069320							1069311			FRP90
 N = 2	9,52	3,18		3,9	0,8	SDMX 090308 1196-05														1069204			FRP90
 N = 4	9,52	4,76		4,4	1,5	SNKX 0904 AN 1187-00	1052316	1052294	1068006							1052234	1052339						FMT45 EBT X ERT90
	12,7	5,56		5,2	2	SNKX 1205 AN 1187-10	1052301	1052230	1068007	1052315	1052228					1052234	1052339			1052236			MMT45 MMT87 FMT45 FMT87 EBT X ERT90 FRT90
	19,05	7,94		6,5	3	SNEX 1907 AN 1187-30		1052364			1052362									1052356			
 N = 4	12,7	5,56		5,2	2	SNKX 1205 AN-TR 1187-10 TR	1052248	1052245		1052239	1052237						1052251			1052249			MMT45 MMT87 FMT45 FMT87 EBT X ERT90 FRT90

¹⁾ **LC280TT** Schruppgeometrie mit 2-fach Beschichtung
 Roughing geometry with double coating

Sortenbeschreibung/-bezeichnung und ISO-Code ab Seite 22
 Description/Designation of grades and ISO-Code starting page 22

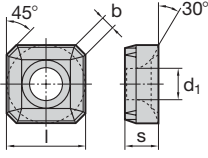
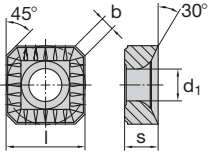
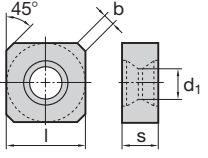
N = Anzahl der Schneidkanten N = Number of cutting edges						ISO-Code Cat-No.	Schneidstoffsorten Cutting materials Ident No.											Für Fräser For cutter Cat-No.					
	l	s	d	d ₁	b/r		LC240T	LC240S	LC230F	LC225T	LC225S	LC630T	LW240	LW225	LC440T	LC444W	LC610E		LC610T	LC610W	LC610A	LW610	LC603Z
 N = 4	9,52	4,76		4,4	1,5	SNKX 0904 AN-TT	1055743 ¹⁾																FMT45 EBT X ERT90
	12,7	5,44		5,2	2	SNKX 1205 AN-T 1187-12	1052303	1052258	1068008	1052314	1052256	1052252	1052250				1052309				1052254		MMT45 MMT87 FMT45 FMT87 EBT X ERT90 FRT90
 N = 4	12,7	5,56		5,2	2	SNKX 1205 AN-TT	1055742 ¹⁾																MMT45 MMT87 FMT45 FMT87 EBT X ERT90 FRT90
	12,7	5,56		5,2	2	SNKQ 1205 AN 1187-13		1052310													1052305		MMT45 MMT87 FMT45 FMT87 ERT90
 N = 8 Breitschichtplatte Wiper N = 1 s = ± 0,01 d = ± 0,015	19,05	5,56	12,7	5,2		1187-90				2305343		2304503											MMT45 FMT45
	12,7	5,56		5,2	2	SNHX 1205 AE 1187-18			1068005	1052306		1052300	1067543										FMV45

¹⁾ LC280TT Schruppgeometrie mit 2-fach Beschichtung
Roughing geometry with double coating

Sortenbeschreibung/-bezeichnung und ISO-Code ab Seite 22
Description/Designation of grades and ISO-Code starting page 22

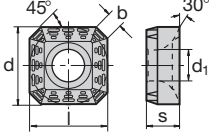
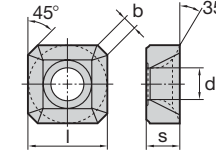
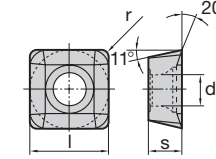
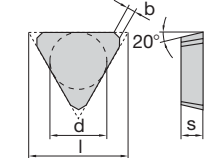
N = Anzahl der Schneidkanten N = Number of cutting edges						ISO-Code Cat-No.	Schneidstoffsorten Cutting materials Ident No.											Für Fräser For cutter Cat-No.						
	l	s	d	d ₁	b/r		LC240T	LC240S	LC230F	LC225T	LC225S	LC630T	LW240	LW225	LC440T	LC444W	LC610E		LC610T	LC610W	LC610A	LW610	LC6603Z	
 N = 4	12,7	5,56		5,2	2	SNHX 1205 AESN-BM									1067537									
 N = 4	12,7	5,56		5,2	2	SNHX 1205 AE-ALC 1187-18 ALC											1052255		1068030	1052235			FMV45	
 N = 4	9,52	4,76		4,4	0,6	SPKX 090406 1187-05	1055658			1069538		1055657	1069537			1069548				1069547			FMT90	
		12,7	5,56		5,2	0,8	SPKX 120508 1187-15	1052247 1052246			1052244			1052240			1052659				1052242			11260-12 FMT90 MMT90
 N = 3	22	4,76	12,7		1,6	TEAN 2204 ZZ 1172-25				1055405			1055401							1055403				

Sortenbeschreibung/-bezeichnung und ISO-Code ab Seite 22
Description/Designation of grades and ISO-Code starting page 22

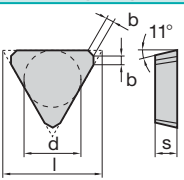
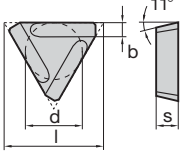
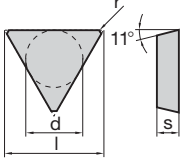
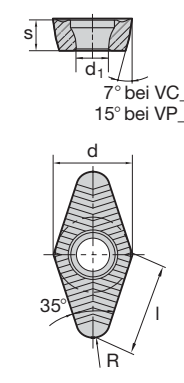
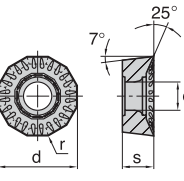
N = Anzahl der Schneidkanten N = Number of cutting edges						ISO-Code Cat-No.	Schneidstoffsorten Cutting materials Ident No.										Für Fräser For cutter Cat-No.								
	l	s	d	d ₁	b/r		LC240T	LC240S	LC230F	LC225T	LC225S	LC630T	LW240	LW225	LC440T	LC444W		LC610E	LC610T	LC610W	LC610A	LW610	LC603Z		
 <p>N = 3</p>	16,5	3,18	9,525		1,2	TPAN 1603 PP 1175-11							1056897												
 <p>N = 3</p>	16,5	3,18	9,525		1,2	TPAR 1603 PDR 1165-12							1052007						1051883	1052016				MMP90	
 <p>N = 3</p>	16,5	3,18	9,525		1,2	TPEN 160312 1170-11							1054390							1054363				MMP90	
		16,5	3,18	9,525		1,2	TPMN 160312 1170-10							1054345							1054218	1054363			
	11,61	3,18	6,35	2,8	0,4	VPGT110304-ALM																		EMZ90 FMZ90	
	16,6	4,76	9,52	4,4	1,2	VPGT160412-ALM												1069756			1069755				
	16,6	4,76	9,52	4,4		VPGT 1604PPFR-ALM												1068012			1068011				
	22,1	5,56	12,7	5,5	3	VCVT220530-ALM												1069760			1069759				
		6,35	16	5,8		XCKX1606ZDR-TR	1055677		1068010		1055676		1055674	1055673				1055678			1055675				FCT45 MCT45

Sortenbeschreibung/-bezeichnung und ISO-Code ab Seite 22
Description/Designation of grades and ISO-Code starting page 22

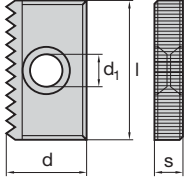
N = Anzahl der Schneidkanten N = Number of cutting edges							Cat-No.	Norm/ Gewindeart Thread standard	Teilung/Steigung mm bzw Gg/1" Pitch lead mm resp. tpi	Schneidstoffsorte Cutting material Ident No.	Für Fräser For cutter
	l	s	d	d ₁	b	r				LC225S ¹⁾	Cat-No.
 <p>N = 2 s = ± 0,01 l = ± 0,01</p>	25,4	5	14,3	5,5			1144-10	Metrisch ISO Innen	1	1041170	ETZ90
							1144-10	Metric ISO Internal	1,5	1041171	
							1144-12		2	1041172	
	25,4	5	15,35	5,5					3	1041173	
							1144-14		4	1041174	
	19,05	3,97	11,1	4,5					1	1041175	
							1144-70		1,5	1041176	
							1144-72		2	1041177	
							1144-74				
	14,3	3,30	11,1	4,5					1	1041178	
							1144-80				
							1144-82		1,5	1041179	
							1144-84		2	1041180	
	25,4	5	14,3	5,5				Metrisch ISO Außen	1,5	1041181	
								Metric ISO External	2	1041182	
	25,4	5	14,3	5,5				Whitworth-/ Whitworth-	11	1041183	
	19,05	3,97	11,1	4,5				Rohrgewinde Innen/Außen	11	1041184	
	14,3	3,3	10	4,5				BSW BSW BSP Internal/External	14	1041185	
	25,4	5	14,3	5,5				UN-Gewinde	16	1041186	
	19,05	3,97	11	4,5				ANSI B 1.1 Innen	20	1041187	
							ANSI B 1.1 Internal BS 1580	16	1041188		
								12	1041189		
14,3	3,3	10	4,5					20	1041190		
								16	1041191		
								12	1041192		

¹⁾ Auch geeignet für das Gewindefräsen von Guß und NE-Metallen
¹⁾ Also useable for thread milling of cast iron and non-ferrous metals
 Wendeplatten für andere Gewindearten und/oder Steigungen auf Anfrage
 Indexable inserts for other thread types and/or leads on request
 Andere Beschichtungen auf Anfrage
 Other coatings upon request

Sortenbeschreibung/-bezeichnung und ISO-Code ab Seite 22
 Description/Designation of grades and ISO-Code starting page 22

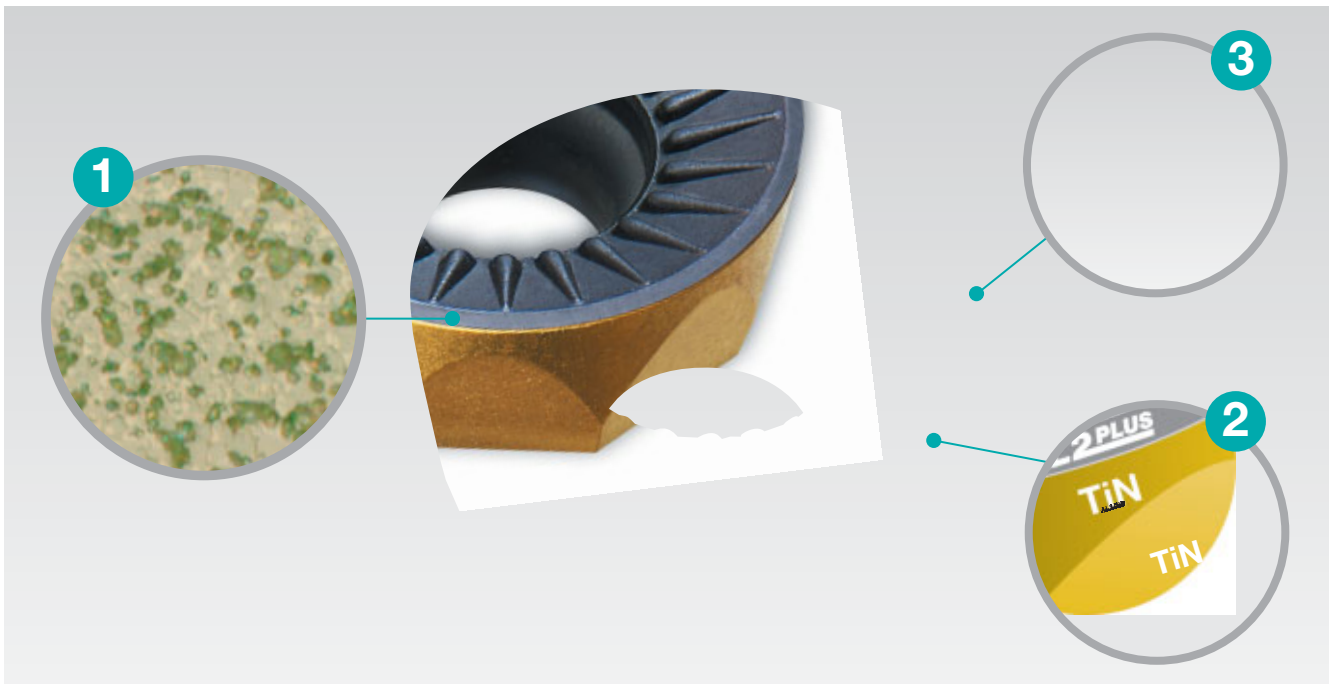

1 Besonders zähes Hartmetallssubstrat

- geringe Ausbruchsneigung
- besonders für lange Ausspannung
- bestens geeignet für stark unterbrochenen Schnitt
- unschlagbar bei stabilen Bedingungen und höchsten Vorschüben

1 Unusually tough carbide substrate

- low chipping tendency
- especially suited for unstable conditions
- particularly suitable for heavily interrupted cutting
- unbeatable under stable conditions and very high feed rates

2 2-fach PVD-Beschichtung AL2Plus und TiN-Schicht am Umfang

- erlaubt hohe Schnittgeschwindigkeiten und Vorschübe
- Reduzierung der Bearbeitungszeit und der Fertigungskosten
- bessere Verschleißerkennung
- eindeutiges Erkennungsmerkmal als Schrupp-Wendeplatte

2 Double PVD coating, AL2Plus and TiN layer at the perimeter

- allows high cutting speed and feed rates
- reduction of machining time and manufacturing costs
- improved wear detection
- clear identification feature as roughing indexable insert

3 Neuentwickelte besonders stabile Mikrogeometrie zum Schruppen

- sichere Bearbeitung auch bei schwierigen Bedingungen
- sicherer Einsatz
- verhindert Ausbrüche

3 Newly developed, particularly stable micro-geometry for roughing



- reliable machining even under difficult conditions
- long tool life through optimum micro-geometry
- averts chipping

Empfohlene maximale Zahnvorschübe f_z (mm) für Wendeplatten LC280TT

Zahnvorschub und Spantiefe sind abhängig von Werkzeug- \emptyset , WP- \emptyset und Ausspannlänge!

Recommended maximum feed per tooth f_z (mm) for inserts LC280TT



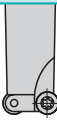
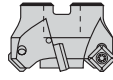
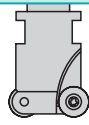
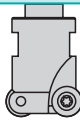



Feed per tooth and depth of cut tool-dia., indexable insert dia. and unclamped length!

Cat.-No.	FCZ 11350			FCT FCT45 FCTXX 11355			ECZ 11460			FMT45 11250-09 11250-12		ECZ 11465				ECT 11467		
																		
\emptyset mm	42-80			42-125			12-40			32-160		8-40				10-40		
ISO-Code	RDHW RDHX			RCKX, RCKT OCKX			RDKT			SNKX		RDKT				RCKT		
WP- \emptyset	10	12	16	10	12	16	8	10	12	9,52	12,7	7	8	10	12	8	10	12
max. a_p	2,5	3	5	2,5	3	5	2	2,5	3	5	7	1,5	2	2,5	3	2	2,5	3
	0,25	0,4	0,45	0,25	0,4	0,45	0,25	0,25	0,4	0,4	0,5	0,3	0,35	0,37	0,4	0,35	0,25	0,3
	0,12	0,15	0,2	0,12	0,15	0,2	0,1	0,12	0,15	0,15	0,15	0,1	0,12	0,12	0,15	0,12	0,12	0,15
	0,4	0,4	0,4	0,3	0,4	0,4	0,3	0,35	0,4	0,5	0,6	0,25	0,3	0,35	0,4	0,3	0,35	0,4
	0,3	0,3	0,3	0,25	0,3	0,3	0,2	0,25	0,3	0,25	0,3	0,15	0,2	0,25	0,3	0,2	0,25	0,3

Schnittwertempfehlungen für Kopierfräser zum Schruppen mit LC280TT







Cutting data recommendations for Copying-Cutters for roughing with LC280TT

Werkstoff	Material	Werkstoff-Nr. Material No.	DIN Bez. DIN Des.	Schnittgeschwindigkeit v_c m/min Cutting speed v_c m/min		
				HM-Sorte Carbide Grade	Schruppen Roughing LC280TT	
Unlegierter Baustahl	Unalloyed tool steel	1.1730	C45W	LC280TT	270	
		1.1545	C105W		270	
	Vergütbare Formenstähle	Heat-treatable die steels	1.2311		40CrMnMo7	250
			1.2312		40CrMnMoS8.6.	250
			1.2738		40CrMnNiMo8.6.4	250
			1.2711		54NiCrMoV6	225
	Einsatzstähle	Case hardening steels	1.2162		21MnCr5	270
			1.2764		X19NiCrMo4	250
	Durchhärtende Werkzeugstähle	Full hardening tool steels	1.2343		X38CrMoV5.1	225
			1.2344		X40CrMoV5.1	225
			1.2367		X38CrMoV5.3	210
			1.2080		X210Cr12	210
			1.2379		X155CrVMo12.1	210
			1.2767		X45NiCrMo4	200
1.2842			90MnCrV8	225		
Nitrierstähle	Nitriding steels	1.8550	34CrAlNi7	200		
		1.8519	31CrMoV9	180		
		1.7735	14CrMoV6.9	180		
		1.2344	X40CrMoV5.1	160		
Korrosionsbeständige Stähle	Stainless steels	1.2083	X42CrMo13	LC280TT	220	
		1.2316	X36CrMo17		220	
		1.4541	X6CrNiTi18.10		350	
		1.4571	X8CrNiMoTi17.12.2		250	
		1.4401	X5CrNiMo17.12.2		350	
		1.4521	X1CrMoTi18.2		250	
		1.4893	X8CrNiNb11		300	
		1.4313	(G-)X4CrNi13.4		300	
		1.2709	X3NiCrMoTi18.9.5		350	
Grauguss und legierter Grauguss	Grey cast iron and alloyed grey cast iron	0.6025	GG25	LC280TT	240	
			GG25CrMoV		240	
	Kugelgraphitguss und legierter Kugelgraphitguss	Nodular cast iron and alloyed nodular cast iron	0.7040		GGG40	225
			0.7070		GGG70	200
		GGG70 legiert alloyed	200			
Gehärteter Stahl Hartguss	Hardened steel	45-52HRC		LC280TT	150	
	Chilled cast iron				150	

Werkstoff Material	R _m /UTS (N/mm ²)	Schnittgeschwindigkeit Cutting speed v _c m/min für Vorschub/Zahn for feed/tooth						
		0,08 - 0,15		0,16 - 0,35		0,36 - 0,50		
								
Unlegierter Baustahl	Plain carbon steel	- 700	210	265	165	220	130	175
Automatenstahl	Free cutting steel	- 700	210	265	165	220	130	175
Baustahl	Structural alloy steel	500 - 950	210	265	165	220	130	175
Vergütungsstahl, mittelfest	Heat-treatment steel, medium strength	500 - 950	170	215	135	180	110	145
Stahlguss	Cast steel	- 950	170	215	135	180	110	145
Einsatzstahl	Case hardening steel	- 950	170	215	135	180	110	145
Rost- und säurebeständiger Stahl, ferritisch, martensitisch	Stainless steel, ferritic, martensitic	500 - 950	170	215	135	180	110	145
Vergütungsstahl, hochfest	Heat-treatment steel, high strength	950 - 1400	150	190	120	160	95	130
Nitrierstahl, vergütet	Nitriding steel	950 - 1400	150	190	120	160	95	130
Werkzeugstahl	Tool steel	950 - 1400	150	190	120	160	95	130
Rost- und säurebeständiger Stahl, austenitisch	Stainless steel, austenitic	500 - 950	230	290	180	240	145	190
Martensitaushärtbarer Stahl	Maraging steel		230	290	180	240	145	190
Grauguss	Grey cast iron	100 - 400 (120 - 260 HB)	210	265	165	220	130	175
Legierter Grauguss	Alloyed grey cast iron	150 - 250 (160 - 230 HB)	170	215	135	180	110	145
Sphäroguss	Nodular cast iron	400 - 800 (120 - 310 HB)	150	190	120	160	95	130
Temperguss	Malleable cast iron	350 - 700 (150 - 280 HB)	150	190	120	160	95	130
Rein-Metalle, weich	Pure metals, soft	- 500						
Aluminium-Legierungen, langspanend	Aluminium alloys, long chipping	- 550						
Aluminium-Legierungen, kurzspanend	Aluminium alloys, short chipping	- 400						
Kupfer-Legierungen, langspanend	Copper alloys, long chipping	300 - 700						
Kupfer-Legierungen, kurzspanend	Copper alloys, short chipping	- 500						
Magnesium-Legierungen	Magnesium alloys	160 - 300						
Thermoplaste	Thermoplastics	40 - 70						
Duroplaste	Duroplastics	20 - 40						
Graphit	Graphite							
Titan-Legierungen, mittelfest	Titanium alloys, medium strength	- 950						
Titan-Legierungen, hochfest	Titanium alloys, high strength	900 - 1400						
Nickelbasis-Legierungen, mittelfest	Nickel based alloys, medium strength	- 950	-	-	-	70	-	-
Nickel-Basis-Legierungen, hochwarmfest	Heat resistant nickel based alloys, high strength	900 - 1400	-	-	-	50	-	-
Hartguss	Chilled cast iron	300 - 600 HB	-	-	-	50	-	-
Gehärteter Stahl	Hardened steel	45 - 52 HRC 53 - 59 HRC 60 - 65 HRC	-	-	-	50	-	-







 Naßbearbeitung
Wet machining

 Trockenbearbeitung
Dry machining

Werkstoff	Material	R _m /UTS (N/mm ²)	Schnittgeschwindigkeit Cutting speed v _c m/min für Vorschub/Zahn for feed/tooth					
			0,08 - 0,15		0,16 - 0,35		0,36 - 0,50	
								
Unlegierter Baustahl	Plain carbon steel	- 700	140	230	120	200	110	160
Automatenstahl	Free cutting steel	- 700	140	230	120	200	110	160
Baustahl	Structural alloy steel	500 - 950	140	230	120	200	110	160
Vergütungsstahl, mittelfest	Heat-treatment steel, medium strength	500 - 950	120	170	120	150	90	120
Stahlguss	Cast steel	- 950	120	170	120	150	90	120
Einsatzstahl	Case hardening steel	- 950	120	170	120	150	90	120
Rost- und säurebeständiger Stahl, ferritisch, martensitisch	Stainless steel, ferritic, martensitic	500 - 950	150	160	130	170	100	140
Vergütungsstahl, hochfest	Heat-treatment steel, high strength	950 - 1400	110	160	100	140	80	110
Nitrierstahl, vergütet	Nitriding steel	950 - 1400	120	160	100	140	80	110
Werkzeugstahl	Tool steel	950 - 1400	120	160	100	140	80	110
Rost- und säurebeständiger Stahl, austenitisch	Stainless steel, austenitic	500 - 950	80	160	-	-	-	-
Martensitaushärtbarer Stahl	Maraging steel							
Grauguss	Grey cast iron	100 - 400 (120 - 260 HB)						
Legierter Grauguss	Alloyed grey cast iron	150 - 250 (160 - 230 HB)						
Sphäroguss	Nodular cast iron	400 - 800 (120 - 310 HB)	150	180	130	160	95	130
Temperguss	Malleable cast iron	350 - 700 (150 - 280 HB)						
Rein-Metalle, weich	Pure metals, soft	- 500						
Aluminium-Legierungen, langspanend	Aluminium alloys, long chipping	- 550						
Aluminium-Legierungen, kurzspanend	Aluminium alloys, short chipping	- 400						
Kupfer-Legierungen, langspanend	Copper alloys, long chipping	300 - 700						
Kupfer-Legierungen, kurzspanend	Copper alloys, short chipping	- 500						
Magnesium-Legierungen	Magnesium alloys	160 - 300						
Thermoplaste	Thermoplastics	40 - 70						
Duroplaste	Duroplastics	20 - 40						
Graphit	Graphite							
Titan-Legierungen, mittelfest	Titanium alloys, medium strength	- 950						
Titan-Legierungen, hochfest	Titanium alloys, high strength	900 - 1400						
Nickelbasis-Legierungen, mittelfest	Nickel based alloys, medium strength	- 950						
Nickel-Basis-Legierungen, hochwarmfest	Heat resistant nickel based alloys, high strength	900 - 1400						
Hartguss	Chilled cast iron	300 - 600 HB						
Gehärteter Stahl	Hardened steel	45 - 52 HRC 53 - 59 HRC 60 - 65 HRC						

 Naßbearbeitung
Wet machining

 Trockenbearbeitung
Dry machining

Werkstoff Material	R _m /UTS (N/mm ²)	Schnittgeschwindigkeit Cutting speed v _c m/min für Vorschub/Zahn for feed/tooth						
		0,08 - 0,15		0,16 - 0,35		0,36 - 0,50		
								
Unlegierter Baustahl	Plain carbon steel	- 700	160	240	150	220	120	160
Automatenstahl	Free cutting steel	- 700	160	240	150	220	120	160
Baustahl	Structural alloy steel	500 - 950	160	240	150	220	120	160
Vergütungsstahl, mittelfest	Heat-treatment steel, medium strength	500 - 950	150	190	130	160	110	140
Stahlguss	Cast steel	- 950	150	190	130	160	110	140
Einsatzstahl	Case hardening steel	- 950	150	190	130	160	110	140
Rost- und säurebeständiger Stahl, ferritisch, martensitisch	Stainless steel, ferritic, martensitic	500 - 950	160	220	130	180	100	140
Vergütungsstahl, hochfest	Heat-treatment steel, high strength	950 - 1400	120	160	90	130	70	100
Nitrierstahl, vergütet	Nitriding steel	950 - 1400	120	160	90	130	70	100
Werkzeugstahl	Tool steel	950 - 1400	120	160	90	130	70	100
Rost- und säurebeständiger Stahl, austenitisch	Stainless steel, austenitic	500 - 950	120	180	-	-	-	-
Martensitaushärtbarer Stahl	Maraging steel							
Grauguss	Grey cast iron	100 - 400 (120 - 260 HB)						
Legierter Grauguss	Alloyed grey cast iron	150 - 250 (160 - 230 HB)						
Sphäroguss	Nodular cast iron	400 - 800 (120 - 310 HB)	150	190	125	165	105	140
Temperguss	Malleable cast iron	350 - 700 (150 - 280 HB)						
Rein-Metalle, weich	Pure metals, soft	- 500						
Aluminium-Legierungen, langspanend	Aluminium alloys, long chipping	- 550						
Aluminium-Legierungen, kurzspanend	Aluminium alloys, short chipping	- 400						
Kupfer-Legierungen, langspanend	Copper alloys, long chipping	300 - 700						
Kupfer-Legierungen, kurzspanend	Copper alloys, short chipping	- 500						
Magnesium-Legierungen	Magnesium alloys	160 - 300						
Thermoplaste	Thermoplastics	40 - 70						
Duroplaste	Duroplastics	20 - 40						
Graphit	Graphite							
Titan-Legierungen, mittelfest	Titanium alloys, medium strength	- 950						
Titan-Legierungen, hochfest	Titanium alloys, high strength	900 - 1400						
Nickelbasis-Legierungen, mittelfest	Nickel based alloys, medium strength	- 950						
Nickel-Basis-Legierungen, hochwarmfest	Heat resistant nickel based alloys, high strength	900 - 1400						
Hartguss	Chilled cast iron	300 - 600 HB						
Gehärteter Stahl	Hardened steel	45 - 52 HRC 53 - 59 HRC 60 - 65 HRC						



 Naßbearbeitung
Wet machining

 Trockenbearbeitung
Dry machining

Werkstoff	Material	R _m /UTS (N/mm ²)	Schnittgeschwindigkeit Cutting speed v _c m/min für Vorschub/Zahn for feed/tooth					
			0,08 - 0,15		0,16 - 0,35		0,36 - 0,50	
								
Unlegierter Baustahl	Plain carbon steel	- 700		160		130		110
Automatenstahl	Free cutting steel	- 700		160		130		110
Baustahl	Structural alloy steel	500 - 950		160		130		110
Vergütungsstahl, mittelfest	Heat-treatment steel, medium strength	500 - 950		110		100		90
Stahlguss	Cast steel	- 950		110		100		90
Einsatzstahl	Case hardening steel	- 950		110		100		90
Rost- und säurebeständiger Stahl, ferritisch, martensitisch	Stainless steel, ferritic, martensitic	500 - 950						
Vergütungsstahl, hochfest	Heat-treatment steel, high strength	950 - 1400		90		80		70
Nitrierstahl, vergütet	Nitriding steel	950 - 1400		90		80		70
Werkzeugstahl	Tool steel	950 - 1400		80		60		
Rost- und säurebeständiger Stahl, austenitisch	Stainless steel, austenitic	500 - 950						
Martensitaushärtbarer Stahl	Maraging steel							
Grauguss	Grey cast iron	100 - 400 (120 - 260 HB)						
Legierter Grauguss	Alloyed grey cast iron	150 - 250 (160 - 230 HB)						
Sphäroguss	Nodular cast iron	400 - 800 (120 - 310 HB)						
Temperguss	Malleable cast iron	350 - 700 (150 - 280 HB)						
Rein-Metalle, weich	Pure metals, soft	- 500						
Aluminium-Legierungen, langspanend	Aluminium alloys, long chipping	- 550						
Aluminium-Legierungen, kurzspanend	Aluminium alloys, short chipping	- 400						
Kupfer-Legierungen, langspanend	Copper alloys, long chipping	300 - 700						
Kupfer-Legierungen, kurzspanend	Copper alloys, short chipping	- 500						
Magnesium-Legierungen	Magnesium alloys	160 - 300						
Thermoplaste	Thermoplastics	40 - 70						
Duroplaste	Duroplastics	20 - 40						
Graphit	Graphite							
Titan-Legierungen, mittelfest	Titanium alloys, medium strength	- 950						
Titan-Legierungen, hochfest	Titanium alloys, high strength	900 - 1400						
Nickelbasis-Legierungen, mittelfest	Nickel based alloys, medium strength	- 950						
Nickel-Basis-Legierungen, hochwarmfest	Heat resistant nickel based alloys, high strength	900 - 1400						
Hartguss	Chilled cast iron	300 - 600 HB						
Gehärteter Stahl	Hardened steel	45 - 52 HRC 53 - 59 HRC 60 - 65 HRC						

 Naßbearbeitung
Wet machining

 Trockenbearbeitung
Dry machining



Werkstoff	Material	Brinell Härte Hardness Brinell HB	Schnittgeschwindigkeit v_c m/min für f_z Cutting speed v_c m/min for feed/tooth f_z	
			0,08 - 0,15 	0,16 - 0,35 
Austenitisch: WNr. 1.4300, 1.4301, 1.4303, 1.4305, 1.4306, 1.4310, 1.4311, 1.4321, 1.4401, 1.4404, 1.4406, 1.4428, 1.4435, 1.4436, 1.4438, 1.4449	Austenitic: AISI 301, 303, 304, 304L, 304LN, 305, 308, 316, 316L, 316LN, 317L	180	250 - 320	200 - 280
1.4362, 1.4541, 1.4543, 1.4544, 1.4550, 1.4552, 1.4571, 1.4581, 1.4583, 1.4878	316Ti, 318, 321, 347, 348	180	250 - 320	200 - 280
Austenitisch gehärtet: WNr. 1.4504, 1.4534, 1.4542, 1.4548, 1.4828, 1.4845, 1.4871,	Austenitic hardened: AISI 309, 310S, 630, J775 (SAE)		200 - 280	
Duplex (austenitisch/ferritisch): WNr. 1.4417, 1.4460, 1.4462, 1.4463, 1.4467, 1.4468, 1.4515, 1.45151, .4582	Duplex (austenitic/ferritic): AISI 329		200 - 280	
Wärmefeste Legierungen; Ni- oder Co- Basis: Inconel 718, Incoloy 925	Heat resisting alloys: Ni- or Co-basis: Inconel 718, Incoloy 925	320-350		
Titanlegierungen; Alpha- + Beta-Legierungen: Ti -6Al-4V	Titanium alloys: Alpha- + Beta-alloys: Ti -6Al-4V	R _m 1050 N/mm ²		



Trockenbearbeitung
Dry machining

Für ferritische und martensitische rostbeständige Stähle empfehlen wir die Sorte LC230F (Vorzugsweise trocken).
For ferritic and martensitic stainless steels we recommend grade LC230F (preferably dry machining)







Schnittwertempfehlungen für LC444W
Cutting data recommendations for LC444W

Werkstoff	Material	Brinell Härte Hardness Brinell HB	Schnittgeschwindigkeit v_c m/min für f_z Cutting speed v_c m/min for feed/tooth f_z	
			0,08 - 0,20 	0,21 - 0,40 
Austenitisch: WNr. 1.4300, 1.4301, 1.4303, 1.4305, 1.4306, 1.4310, 1.4311, 1.4321, 1.4401, 1.4404, 1.4406, 1.4428, 1.4435, 1.4436, 1.4438, 1.4449	Austenitic: AISI 301, 303, 304, 304L, 304LN, 305, 308, 316, 316L, 316LN, 317L	180	80 - 160	70 - 140
1.4362, 1.4541, 1.4543, 1.4544, 1.4550, 1.4552, 1.4571, 1.4581, 1.4583, 1.4878	316Ti, 318, 321, 347, 348	180	70 - 125	50 - 120
Austenitisch gehärtet: WNr. 1.4504, 1.4534, 1.4542, 1.4548, 1.4828, 1.4845, 1.4871,	Austenitic hardened: AISI 309, 310S, 630, J775 (SAE)		70 - 100	
Duplex (austenitisch/ferritisch): WNr. 1.4417, 1.4460, 1.4462, 1.4463, 1.4467, 1.4468, 1.4515, 1.45151, .4582	Duplex (austenitic/ferritic): AISI 329		70 - 120	
Wärmefeste Legierungen; Ni- oder Co- Basis: Inconel 718, Incoloy 925	Heat resisting alloys: Ni- or Co-basis: Inconel 718, Incoloy 925	320-350	40 - 70	30 - 60
Titanlegierungen; Alpha- + Beta-Legierungen: Ti -6Al-4V	Titanium alloys: Alpha- + Beta-alloys: Ti -6Al-4V	R _m 1050 N/mm ²	45 - 60	40 - 55









Naßbearbeitung
Wet machining

Für ferritische und martensitische rostbeständige Stähle empfehlen wir die Sorte LC230F (Vorzugsweise trocken).
For ferritic and martensitic stainless steels we recommend grade LC230F (preferably dry machining)

Werkstoff	Material	R _m /UTS (N/mm ²)	Schnittgeschwindigkeit Cutting speed v _c m/min für Vorschub/Zahn for feed/tooth					
			0,08 - 0,15		0,16 - 0,35		0,36 - 0,50	
								
Unlegierter Baustahl	Plain carbon steel	- 700						
Automatenstahl	Free cutting steel	- 700						
Baustahl	Structural alloy steel	500 - 950						
Vergütungsstahl, mittelfest	Heat-treatment steel, medium strength	500 - 950						
Stahlguss	Cast steel	- 950						
Einsatzstahl	Case hardening steel	- 950						
Rost- und säurebeständiger Stahl, ferritisch, martensitisch	Stainless steel, ferritic, martensitic	500 - 950						
Vergütungsstahl, hochfest	Heat-treatment steel, high strength	950 - 1400						
Nitrierstahl, vergütet	Nitriding steel	950 - 1400						
Werkzeugstahl	Tool steel	950 - 1400						
Rost- und säurebeständiger Stahl, austenitisch	Stainless steel, austenitic	500 - 950						
Martensitaushärtbarer Stahl	Maraging steel							
Grauguss	Grey cast iron	100 - 400 (120-260 HB)	160	320	130	240	90	180
Legierter Grauguss	Alloyed grey cast iron	150 - 250 (160-230 HB)	130	250	100	200	80	150
Sphäroguss	Nodular cast iron	400 - 800 (120-310 HB)	150	180	120	150	90	130
Temperguss	Malleable cast iron	350 - 700 (150-280 HB)	150	280	120	210	90	150
Rein-Metalle, weich	Pure metals, soft	- 500						
Aluminium-Legierungen, langspanend	Aluminium alloys, long chipping	- 550						
Aluminium-Legierungen, kurzspanend	Aluminium alloys, short chipping	- 400						
Kupfer-Legierungen, langspanend	Copper alloys, long chipping	300 - 700						
Kupfer-Legierungen, kurzspanend	Copper alloys, short chipping	- 500						
Magnesium-Legierungen	Magnesium alloys	160 - 300						
Thermoplaste	Thermoplastics	40 - 70						
Duroplaste	Duroplastics	20 - 40						
Graphit	Graphite							
Titan-Legierungen, mittelfest	Titanium alloys, medium strength	- 950						
Titan-Legierungen, hochfest	Titanium alloys, high strength	900 - 1400						
Nickelbasis-Legierungen, mittelfest	Nickel based alloys, medium strength	- 950						
Nickel-Basis-Legierungen, hochwarmfest	Heat resistant nickel based alloys, high strength	900 - 1400						
Hartguss	Chilled cast iron	300 - 600 HB						
Gehärteter Stahl	Hardened steel	45 - 52 HRC 53 - 59 HRC 60 - 65 HRC						







 Naßbearbeitung
Wet machining

 Trockenbearbeitung
Dry machining

Werkstoff	Material	R _m /UTS (N/mm ²)	Schnittgeschwindigkeit Cutting speed v _c m/min für Vorschub/Zahn for feed/tooth					
			0,08 - 0,15		0,16 - 0,35		0,36 - 0,50	
								
Unlegierter Baustahl	Plain carbon steel	- 700	285	360	225	300	180	240
Automatenstahl	Free cutting steel	- 700	285	360	225	300	180	240
Baustahl	Structural alloy steel	500 - 950	285	360	225	300	180	240
Vergütungsstahl, mittelfest	Heat-treatment steel, medium strength	500 - 950	235	300	225	250	150	200
Stahlguss	Cast steel	- 950	235	300	225	250	150	200
Einsatzstahl	Case hardening steel	- 950	235	300	225	250	150	200
Rost- und säurebeständiger Stahl, ferritisch, martensitisch	Stainless steel, ferritic, martensitic	500 - 950	235	300	225	250	150	200
Vergütungsstahl, hochfest	Heat-treatment steel, high strength	950 - 1400	190	240	150	200	120	160
Nitrierstahl, vergütet	Nitriding steel	950 - 1400	190	240	150	200	120	160
Werkzeugstahl	Tool steel	950 - 1400	190	240	150	200	120	160
Rost- und säurebeständiger Stahl, austenitisch	Stainless steel, austenitic	500 - 950						
Martensitaushärtbarer Stahl	Maraging steel							
Grauguss	Grey cast iron	100 - 400 (120 - 260 HB)	285	360	225	300	180	240
Legierter Grauguss	Alloyed grey cast iron	150 - 250 (160 - 230 HB)	220	276	170	230	140	185
Sphäroguss	Nodular cast iron	400 - 800 (120 - 310 HB)	200	250	160	210	125	170
Temperguss	Malleable cast iron	350 - 700 (150 - 280 HB)	200	250	160	210	125	170
Rein-Metalle, weich	Pure metals, soft	- 500	665	840	525	700	420	560
Aluminium-Legierungen, langspanend	Aluminium alloys, long chipping	- 550	950	1000	750	1000	600	800
Aluminium-Legierungen, kurzspanend	Aluminium alloys, short chipping	- 400	380	480	300	400	240	320
Kupfer-Legierungen, langspanend	Copper alloys, long chipping	300 - 700	950	1000	750	1000	600	800
Kupfer-Legierungen, kurzspanend	Copper alloys, short chipping	- 500	380	480	300	400	240	320
Magnesium-Legierungen	Magnesium alloys	160 - 300	-	600	-	500	-	400
Thermoplaste	Thermoplastics	40 - 70	-	600	-	500	-	400
Duroplaste	Duroplastics	20 - 40	-	600	-	500	-	400
Graphit	Graphite		-	600	-	500	-	400
Titan-Legierungen, mittelfest	Titanium alloys, medium strength	- 950						
Titan-Legierungen, hochfest	Titanium alloys, high strength	900 - 1400						
Nickelbasis-Legierungen, mittelfest	Nickel based alloys, medium strength	- 950	80	90	-	-	-	-
Nickel-Basis-Legierungen, hochwarmfest	Heat resistant nickel based alloys, high strength	900 - 1400	60	70	-	-	-	-
Hartguss	Chilled cast iron	300 - 600 HB	60	70	-	-	-	-
Gehärteter Stahl	Hardened steel	45 - 52 HRC	80	90				
		53 - 59 HRC	60	70				
		60 - 65 HRC	40	50				







 Naßbearbeitung
Wet machining

 Trockenbearbeitung
Dry machining

Werkstoff	Material	R _m /UTS (N/mm ²)	Schnittgeschwindigkeit Cutting speed v _c m/min für Vorschub/Zahn for feed/tooth						
			0,08 - 0,15		0,16 - 0,35		0,36 - 0,50		
									
Unlegierter Baustahl	Plain carbon steel	- 700							
Automatenstahl	Free cutting steel	- 700							
Baustahl	Structural alloy steel	500 - 950							
Vergütungsstahl, mittelfest	Heat-treatment steel, medium strength	500 - 950							
Stahlguss	Cast steel	- 950							
Einsatzstahl	Case hardening steel	- 950							
Rost- und säurebeständiger Stahl, ferritisch, martensitisch	Stainless steel, ferritic, martensitic	500 - 950							
Vergütungsstahl, hochfest	Heat-treatment steel, high strength	950 - 1400							
Nitrierstahl, vergütet	Nitriding steel	950 - 1400							
Werkzeugstahl	Tool steel	950 - 1400							
Rost- und säurebeständiger Stahl, austenitisch	Stainless steel, austenitic	500 - 950							
Martensitaushärtbarer Stahl	Maraging steel	-							
Grauguss	Grey cast iron	100 - 400 (120 - 260 HB)							
Legierter Grauguss	Alloyed grey cast iron	150 - 250 (160 - 230 HB)							
Sphäroguss	Nodular cast iron	400 - 800 (120 - 310 HB)							
Temperguss	Malleable cast iron	350 - 700 (150 - 280 HB)							
Rein-Metalle, weich	Pure metals, soft	- 500							
Aluminium-Legierungen, langspanend	Aluminium alloys, long chipping	- 550	500	2500	400	2000			
Aluminium-Legierungen, kurzspanend	Aluminium alloys, short chipping	- 400	500	2000	400	1800			
Kupfer-Legierungen, langspanend	Copper alloys, long chipping	300 - 700							
Kupfer-Legierungen, kurzspanend	Copper alloys, short chipping	- 500							
Magnesium-Legierungen	Magnesium alloys	160 - 300							
Thermoplaste	Thermoplastics	40 - 70	80	120	70	100			
Duroplaste	Duroplastics	20 - 40	80	120	70	100			
Graphit	Graphite								
Titan-Legierungen, mittelfest	Titanium alloys, medium strength	- 950							
Titan-Legierungen, hochfest	Titanium alloys, high strength	900 - 1400							
Nickelbasis-Legierungen, mittelfest	Nickel based alloys, medium strength	- 950							
Nickel-Basis-Legierungen, hochwarmfest	Heat resistant nickel based alloys, high strength	900 - 1400							
Hartguss	Chilled cast iron	300 - 600 HB							
Gehärteter Stahl	Hardened steel	45 - 52 HRC 53 - 59 HRC 60 - 65 HRC							

 Naßbearbeitung
Wet machining

 Trockenbearbeitung
Dry machining

	Werkstoff	Material	R _m /UTS (N/mm ²)	Schnittgeschwindigkeit Cutting speed v _c m/min für Vorschub/Zahn for feed/tooth					
				0,08 - 0,15		0,16 - 0,35		0,36 - 0,50	
									
	Unlegierter Baustahl	Plain carbon steel	- 700						
	Automatenstahl	Free cutting steel	- 700						
	Baustahl	Structural alloy steel	500 - 950						
	Vergütungsstahl, mittelfest	Heat-treatment steel, medium strength	500 - 950						
	Stahlguss	Cast steel	- 950						
	Einsatzstahl	Case hardening steel	- 950						
	Rost- und säurebeständiger Stahl, ferritisch, martensitisch	Stainless steel, ferritic, martensitic	500 - 950						
	Vergütungsstahl, hochfest	Heat-treatment steel, high strength	950 - 1400						
	Nitrierstahl, vergütet	Nitriding steel	950 - 1400						
	Werkzeugstahl	Tool steel	950 - 1400						
	Rost- und säurebeständiger Stahl, austenitisch	Stainless steel, austenitic	500 - 950						
	Martensitaushärtbarer Stahl	Maraging steel	-						
	Grauguss	Grey cast iron	100 - 400 (120 - 260 HB)	80	140	70	110	60	80
	Legierter Grauguss	Alloyed grey cast iron	150 - 250 (160 - 230 HB)	80	120	70	90	60	70
	Sphäroguss	Nodular cast iron	400 - 800 (120 - 310 HB)	90	110	80	90	-	-
	Temperguss	Malleable cast iron	350 - 700 (150 - 280 HB)	60	70	50	60	-	-
	Rein-Metalle, weich	Pure metals, soft	- 500	500	700	400	600	-	-
	Aluminium-Legierungen, langspanend	Aluminium alloys, long chipping	- 550	500	700	400	600	-	-
	Aluminium-Legierungen, kurzspanend	Aluminium alloys, short chipping	- 400	400	600	300	500	-	-
	Kupfer-Legierungen, langspanend	Copper alloys, long chipping	300 - 700	300	400	200	300	-	-
	Kupfer-Legierungen, kurzspanend	Copper alloys, short chipping	- 500	200	300	150	200	-	-
	Magnesium-Legierungen	Magnesium alloys	160 - 300	80	120	70	100	-	-
	Thermoplaste	Thermoplastics	40 - 70	70	80	50	60	-	-
	Duroplaste	Duroplastics	20 - 40	70	80	50	60	-	-
	Graphit	Graphite							
	Titan-Legierungen, mittelfest	Titanium alloys, medium strength	- 950						
	Titan-Legierungen, hochfest	Titanium alloys, high strength	900 - 1400						
	Nickelbasis-Legierungen, mittelfest	Nickel based alloys, medium strength	- 950						
	Nickel-Basis-Legierungen, hochwarmfest	Heat resistant nickel based alloys, high strength	900 - 1400						
	Hartguss	Chilled cast iron	300 - 600 HB						
	Gehärteter Stahl	Hardened steel	45 - 52 HRC 53 - 59 HRC 60 - 65 HRC						

 Naßbearbeitung
Wet machining

 Trockenbearbeitung
Dry machining

Das LMT-Farbleitsystem LMT Colour Identification System

Steigern Sie Ihre Effizienz mit colorguide, dem perfekten Farbleitsystem zur Auswahl der richtigen Wendschneidplatte. Dieser Wegweiser durch die Vielfalt, den Sie auf dem Etikett jeder LMT-Wendschneidplattenschachtel finden, gibt Ihnen rasch und verlässlich Auskunft über die Eignung einer bestimmten Wendeplatte für den jeweiligen Bearbeitungsfall. Colorguide spart Zeit und hilft Fehlanwendungen zu vermeiden.

Increase your efficiency with colorguide, the perfect colour identification system for finding the right indexable insert.

This guide through the variety which you will find on the label of each LMT indexable inserts box informs you quickly and reliably about the suitability of this indexable insert for the intended machining operation. Colorguide saves time and helps to avoid wrong applications.

In einem Raster, der senkrecht in sechs mit Farben gekennzeichnete Materialhauptgruppen (nach VDI 3323) und waagrecht in drei Bearbeitungsstufen (von grob ROUGH über mittel MEDIUM nach fein FINE) geteilt ist, geben die aufgedruckten Symbole Auskunft über den oder die Anwendungsbereiche einer bestimmten Wendeplatte.

Am oben gezeigten Beispiel:

APKT 15T3PDTR-BP in der Sorte LC230F ist hauptsächlich für die mittlere Bearbeitung von Stahl und daneben auch für die mittlere Bearbeitung von nichtrostendem Stahl im kontinuierlichen Schnitt geeignet.

Symbols printed in a grid which is vertically organized into six main material groups represented by colours (acc. to VDI 3323) and horizontally by three levels of machining (ROUGH - MEDIUM - FINE) define the field(s) of application of the indexable insert.

For example, the above label tells you:

APKT 15T3PDTR-BP in grade LC230F is primarily suitable for medium turning of steels but also for turning of stainless steels, both in continuous cut.

In die Materialhauptgruppen fallen die nachstehend angeführten Werkstoffgruppen:

- Stahl: Automaten-, Einsatz-, Vergütungs- und Baustähle, weißer Temperguss
- Nichtrostender Stahl: Ferritische Cr-Stähle, martensitische CrNi-Stähle, austenitische CrNi-Stähle
- Eisenguss: Grauguss, Temperguss, Sphäroguss, Sintereisen
- Nichteisen-Metalle: Al-Knet- und Al-Gusslegierungen, auch Weichkunststoffe, faserverstärkte Kunststoffe
- Hochwarmfeste Legierungen: Hitzebeständige Stähle, Ni-/Co-Basis-Legierungen, Ti-Legierungen
- Gehärtete Werkstoffe: Gehärtete Stähle (45 HRC), Einsatzstähle, Schalenhartguss

The main material groups include the following materials:

- Steel: Free cutting steels, case hardening steels, heat treatment steels, constructional steels, white malleable cast iron
- Stainless steels: Ferritic Cr-steels, martensitic CrNi-steels, austenitic CrNi-steels
- Cast iron: Grey cast iron, malleable cast iron, spheroidal cast iron, sintered iron
- Non-ferrous metal: Al wrought and Al cast alloys, also soft plastics and fiber-reinforced plastics
- High-temperature alloys: Heat resistant steels, alloys on Ni/Co basis, Ti alloys
- Hardened materials: Hardened steels (≥ 45 HRC), case hardened steels, clear chill castings.



Werkstoffgruppen Material groups			
	Rough	Medium	Fine
Stahl Steel	Blue	Light Blue	Very Light Blue
Nichtrostender Stahl Stainless steel	Yellow	Light Yellow	Very Light Yellow
Eisenguss Iron casting	Red	Light Red	Very Light Red
Nichteisen-Metalle Non-ferrous metals	Green	Light Green	Very Light Green
Hochwarmfeste Legierungen High temperature alloys	Orange	Light Orange	Very Light Orange
Gehärtete Werkstoffe Hardened materials	Grey	Light Grey	Very Light Grey

Bearbeitungsarten Machining mode			
	Rough	Medium	Fine
Vorschub f (mm) Feed f (mm)	0,6 – 1,2	0,25 – 0,6	0,05 – 0,25
Schnitttiefe a _p (mm) Depth of cut a _p (mm)	5 – 15	1,5 – 5	0,1 – 1,5

Anwendungsbereiche Application area		
	kontinuierlicher Schnitt Continuous cut	unterbrochener Schnitt Interrupted cut
Hauptanwendung Main application	●	▶
Nebenanwendung Other application	○	▷



Multi-Mill Fräser-System

Multi-Mill Milling Cutter System

Besondere Merkmale Special features	75
Planfräsköpfe 45° Face Milling Cutters 45°	76
Planfräsköpfe 75° Face Milling Cutters 75°	82
Eckfräsköpfe 87°/88° Face Milling Cutters 87°/88°	83
Eckfräsköpfe 90° Face Milling Cutters 90°	86
Kopierfräsköpfe Copy Milling Cutters	90
Grundkörper Basic cutter bodies	91
Kassetten Cartridges	92
Montage- und Einstellanleitung Assembly and adjustment instructions	93
Schnittwertempfehlungen Cutting data recommendations	94

Multi-Mill

Flexibel zu hochpräzisen Ergebnissen
Flexibility for high precise results

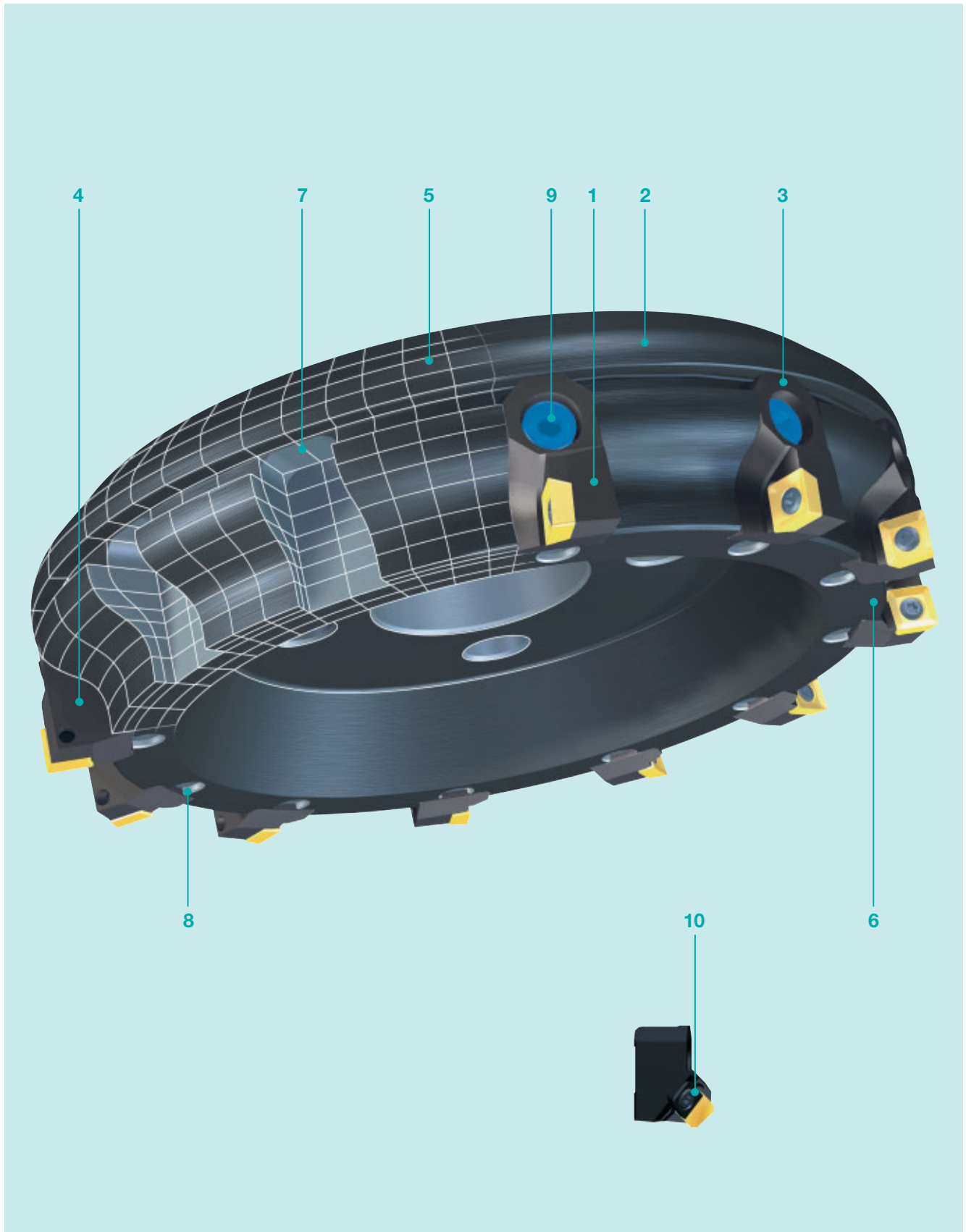

1 Eine Kassettengröße für den gesamten Durchmesser-Bereich.
One cartridge size for all diameters.



3 Breites Einsatzgebiet durch große Bestückungsvielfalt.
Wide tooling diversity for an extensive field of application.



5 Optimale Stabilität durch Einsatz von FEM-Berechnungen bei der Entwicklung.
Optimized stability through development work backed by FEM-computations.



7 Geschliffener Festanschlag für das Fräsen ohne vorherige Feineinstellung (Auslieferungszustand).
Fixed back stop for roughing without previous fine adjustment (as delivered).



9 Eine Klemmschraube für alle Kassetten!
Hochfeste Klemmschraube für hohe Sicherheit bis maximal $v_c = 2000$ m/min.
One clamping screw for all cartridges!
Highly secure clamping screw for maximum safety up to $v_c = 2000$ m/min.



Maximale Zähnezahzahl für das Fräsen mit hohen Vorschubgeschwindigkeiten.
Maximum number of teeth for roughing at high cutting speeds.



2 Zwei Grundvarianten mit Standardteilung und enger Teilung.
Two basic versions with standard and fine pitch.



4 Links- oder rechtsschneidende Kassetten passen in den gleichen Grundkörper.
Use is possible with left- or right-hand cutting cartridges in the same basic cutter body.



6 Ungleichteilung gegen Vibrationen.
Non-symmetrical pitch on all versions against vibrations.



8 Eine Einstellschraube für alle Kassetten!
Hochgenaue Einstellung des Planlaufes, einfach und schnell in beide Richtungen.
One setting screw for all variants!
Precise setting of the runout in all directions.

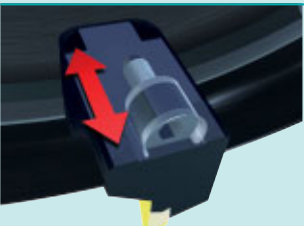

10 Eine Klemmpratze für alle Kassettentypen!
Axial einstellbar, auch mit geklemmten Wendepplatten.
One clamp for all versions!
Axial adjustable also with clamped indexable inserts.



Einstellplatz.
Axialeinstellung, sehr bedienerfreundlich!
Setting area.
Simple setting procedure!



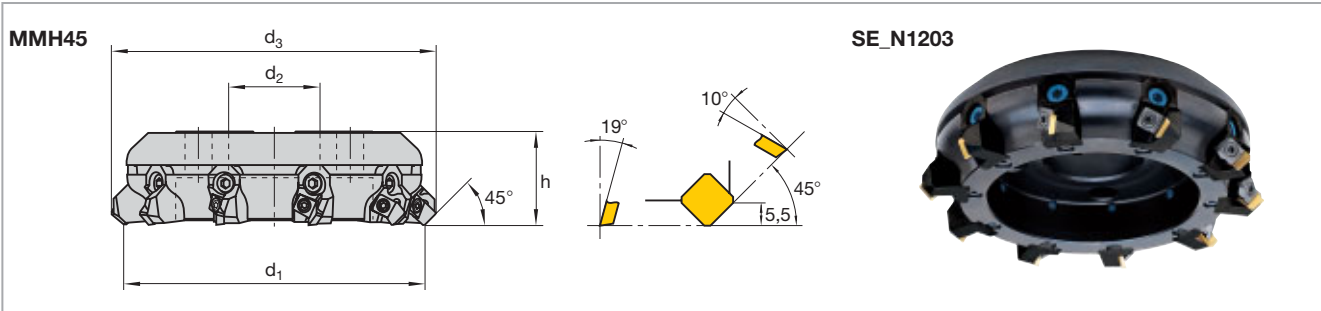

d ₁	d ₃	h	d ₂	Standard		LMT-Code	Eng fine		LMT-Code
				z	Ident No.		z	Ident No.	
100	113	63	32	6	1028100	MMH45 S12.100AN	8	1028111	MMH45 S12.125AN-F
125	138	63	40	6	1028101	MMH45 S12.125AN	12	1028112	MMH45 S12.160AN-F
160	173	63	40	8	1028102	MMH45 S12.160AN	14	1028113	MMH45 S12.200AN-F
200	213	63	60	10	1028103	MMH45 S12.200AN	18	1028114	MMH45 S12.250AN-F
250	263	63	60	12	1028104	MMH45 S12.250AN	22	1028115	MMH45 S12.315AN-F
315	328	80	60	16	1028105	MMH45 S12.315AN	26	1028116	MMH45 S12.400AN-F
400	413	80	60	18	1028106	MMH45 S12.400AN	32	1028117	MMH45 S12.500AN-F
500	513	80	60	22	1028107	MMH45 S12.500AN			

SE_N1203							
Ident No.							
1028072	2337584	1045181	1048427	2141985	2146544	1045713	2147491

N = Anzahl der Schneidkanten N = Number of cutting edges							Schneidstoffsorten Cutting materials										Für Fräser For cutter Cat-No.		
	l	s	d	d ₁	b/r	ISO-Code	LC240T	LC230F	LC225T	LC225S	LW225	LC440T	LC444W	LC610E	LC610T	LC610T		LC610A	LW610
 N = 4	12,7	3,18	12,7		1,4	SEKN 1203AFEN					●	●							MMH45 S12
	12,7	3,18	12,7		1,4	SEAN 1203AFSN	●			●	●								
	12,7	3,18	12,7		1,4	SEKN 1203AFSN	●	●	●	●	●	●			●	●			
 N = 4	12,7	3,18	12,7		1,4	SEKR 1203AFSN	●	●	●	●	●	●							MMH45 S12
 N = 4	12,7	3,18	12,7		1,4	SEKR 1203AFSN-BM						●							MMH45 S12

Sortenbeschreibung/-bezeichnung und ISO-Code ab Seite 22
Description/Designation of grades and ISO-Code starting page 22

Schnittwertempfehlungen ab Seite 94
Cutting data recommendations starting page 94

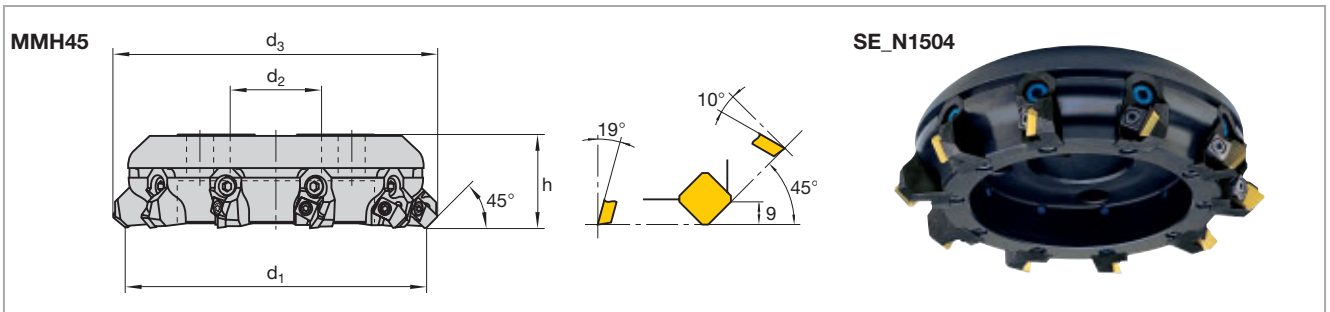

d ₁	d ₃	h	d ₂	z	Standard		Eng fine		LMT-Code
					Ident No.	LMT-Code	z	Ident No.	
100	118	63	32	6	1028140	MMH45 S15.100AN			
125	143	63	40	6	1028141	MMH45 S15.125AN	8	1028151	MMH45 S15.125AN-F
160	178	63	40	8	1028142	MMH45 S15.160AN	12	1028152	MMH45 S15.160AN-F
200	218	63	60	10	1028143	MMH45 S15.200AN	14	1028153	MMH45 S15.200AN-F
250	268	63	60	12	1028144	MMH45 S15.250AN	18	1028154	MMH45 S15.250AN-F
315	333	80	60	16	1028145	MMH45 S15.315AN	22	1028155	MMH45 S15.315AN-F
400	418	80	60	18	1028146	MMH45 S15.400AN	26	1028156	MMH45 S15.400AN-F
500	518	80	60	22	1028147	MMH45 S15.500AN	32	1028157	MMH45 S15.500AN-F

SE_N1504							
Ident No.							
1028041	2337584	1045181	1048427	2141985	2146544	1045713	2147491

N = Anzahl der Schneidkanten N = Number of cutting edges							Schneidstoffsorten Cutting materials										Für Fräser For cutter Cat-No.		
	l	s	d	d ₁	b/r	ISO-Code	LC240T	LC230F	LC225T	LC225S	LW225	LC440T	LC444W	LC610E	LC610T	LC610A		LW610	
 N = 4	15,88	4,76	15,88			SEKN 1504AFEN								●					MMH45 S15
	15,88	4,76	15,88			SEAN 1504AFSN	●			●	●								
	15,88	4,76	15,88			SEKN 1504AFSN	●	●	●	●					●				

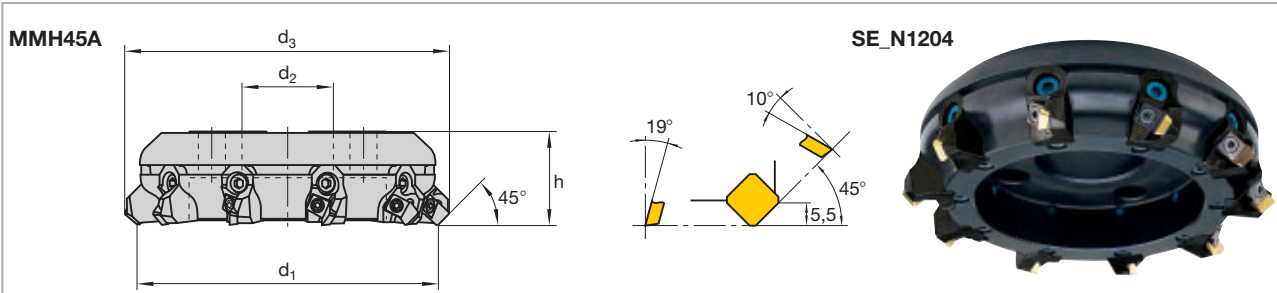

d ₁	d ₃	h	d ₂	Standard		LMT-Code	Eng fine		LMT-Code
				z	Ident.No.		z	Ident.No.	
100	113	63	32	6	1028120	MMH45A S12.100AN	8	1028131	MMH45A S12.125AN-F
125	138	63	40	6	1028121	MMH45A S12.125AN	12	1028132	MMH45A S12.160AN-F
160	173	63	40	8	1028122	MMH45A S12.160AN	14	1028133	MMH45A S12.200AN-F
200	213	63	60	10	1028123	MMH45A S12.200AN	18	1028134	MMH45A S12.250AN-F
250	263	63	60	12	1028124	MMH45A S12.250AN	22	1028135	MMH45A S12.315AN-F
315	328	80	60	16	1028125	MMH45A S12.315AN	26	1028136	MMH45A S12.400AN-F
400	413	80	60	18	1028126	MMH45A S12.400AN	32	1028137	MMH45A S12.500AN-F
500	513	80	60	22	1028127	MMH45A S12.500AN			

SE_N1204							
Ident No.							
1028040	2337584	1045181	1048427	2141985	2146544	1045713	2147491

N = Anzahl der Schneidkanten N = Number of cutting edges							Schneidstoffsorten Cutting materials										Für Fräser For cutter	
	l	s	d	d ₁	b/r	ISO-Code	LC240T	LC230F	LC225T	LC225S	LW225	LC440T	LC444W	LC610E	LC610T	LC610A	LW610	Cat-No.
 N = 4	12,7	4,76	12,7		1,4	SEKN 1204AFEN								●				MMH45A S12
	12,7	4,76	12,7		1,4	SEKN 1204AFSN	●	●	●	●	●			●	●			
 N = 4	12,7	4,76	12,7		1,4	SEKR 1204AFSN	●	●	●	●	●	●						MMH45A S12
 N = 4	12,7	4,76	12,7		1,4	SEKR 1204AFSN-BM								●				MMH45A S12

Sortenbeschreibung/-bezeichnung und ISO-Code ab Seite 22
Description/Designation of grades and ISO-Code starting page 22

Schnittwertempfehlungen ab Seite 94
Cutting data recommendations starting page 94

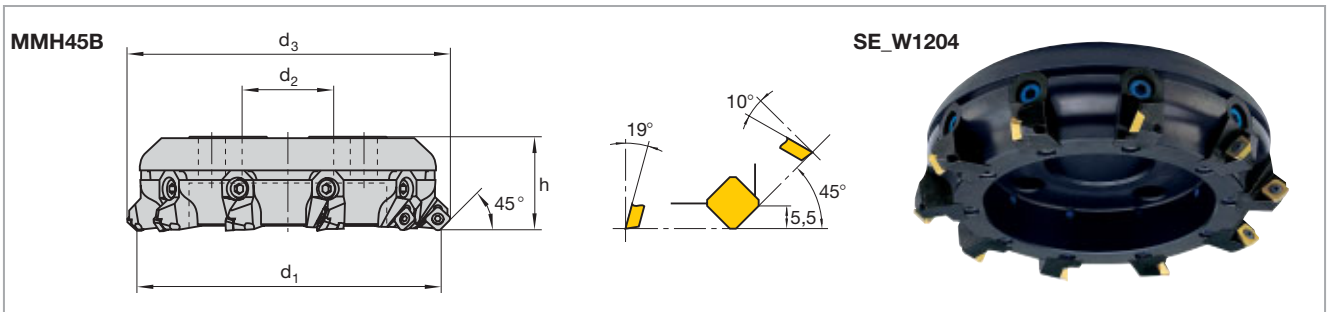

d ₁	d ₃	h	d ₂	Standard		Eng fine	LMT-Code
				z	Ident No.		
100	113	63	32	6	1028360		MMH45B S12.100AN
125	138	63	40	6	1028361	8	MMH45B S12.125AN
160	173	63	40	8	1028362	12	MMH45B S12.160AN
200	213	63	60	10	1028363	14	MMH45B S12.200AN
250	263	63	60	12	1028364	18	MMH45B S12.250AN
315	328	80	60	16	1028365	22	MMH45B S12.315AN
400	413	80	60	18	1028366	26	MMH45B S12.400AN
500	513	80	60	22	1028367	32	MMH45B S12.500AN

SE_W1204						
Ident No.						
1028051	1045777	1048344	2141985	2146544	1045713	2147491

N = Anzahl der Schneidkanten N = Number of cutting edges	Schneidstoffsorten Cutting materials											Für Fräser For cutter Cat-No.							
	l	s	d	d ₁	b/r	ISO-Code	LC240T	LC230F	LC225T	LC225S	LW225		LC440T	LC444W	LC610E	LC610T	LC610A	LW610	
 N = 4	12,7	4,76	12,7	5,5		SEHT 1204AFEN						●							MMH45B S12
	12,7	4,76	12,7	5,5		SEKT 1204AFSN	●	●		●	●								
 N = 4	12,7	4,76	12,7	5,5		SEKW 1204AFEN								●	●				MMH45B S12
	12,7	4,76	12,7	5,5		SEKW 1204AFSN	●	●	●	●	●				●				
 N = 4	12,7	4,76	12,7	5,5		SEHT 1204AFFN-ALC										●	●	●	MMH45B S12
	12,7	4,76	12,7	5,5		SEHT 1204AFSN-BM							●						

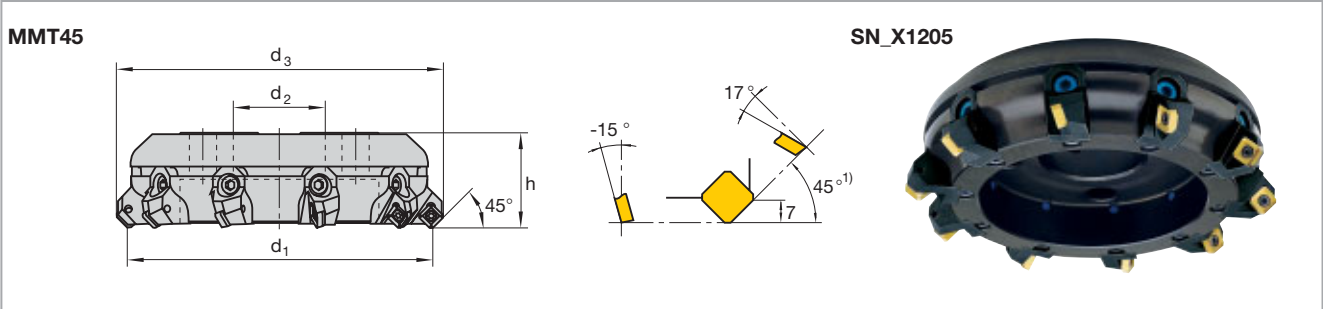

d ₁	d ₃	h	d ₂	Standard		LMT-Code	Eng fine		LMT-Code
				z	Ident No.		z	Ident No.	
100	114	63	32	6	1028160	MMT45 S12.100AN			
125	139	63	40	6	1028161	MMT45 S12.125AN	8	1028171	MMT45 S12.125AN-F
160	174	63	40	8	1028162	MMT45 S12.160AN	12	1028172	MMT45 S12.160AN-F
200	214	63	60	10	1028163	MMT45 S12.200AN	14	1028173	MMT45 S12.200AN-F
250	264	63	60	12	1028164	MMT45 S12.250AN	18	1028174	MMT45 S12.250AN-F
315	329	80	60	16	1028165	MMT45 S12.315AN	22	1028175	MMT45 S12.315AN-F
400	414	80	60	18	1028166	MMT45 S12.400AN	26	1028176	MMT45 S12.400AN-F
500	514	80	60	22	1028167	MMT45 S12.500AN	32	1028177	MMT45 S12.500AN-F

SN_X1205					
Ident No.					
1028050	1045123	1048344	2141985	2146544	1045713 2147491

N = Anzahl der Schneidkanten N = Number of cutting edges	l	s	d	d ₁	b/r	ISO-Code Cat-No.	Schneidstoffsorten Cutting materials Ident No.											Für Fräser For cutter Cat-No.				
							LC240T	LC240S	LC230F	LC225T	LC225S	LC630T	LW240	LW225	LC440T	LC444W	LC610E		LC610T	LC610W	LC610A	LW610
N = 4 	12,7	5,56		5,2	2	SNKX 1205 AN 1187-10	1052301	1052230	1068007	1052315	1052228						1052234	1052339			1052236	MMT45 MMT87 FMT45 FMT87 EBTX ERT90 FRT90
N = 4 	12,7	5,56		5,2	2	SNKX 1205 AN-TR 1187-10 TR	1052248	1052245		1052239	1052237							1052251			1052249	
N = 4 	12,7	5,44		5,2	2	SNKX 1205 AN-T 1187-12	1052303	1052258	1068008	1052314	1052256							1052309			1052254	MMT45 MMT87 FMT45 FMT87 EBTX ERT90 FRT90
N = 8 	12,7	5,56		5,2	2	SNKQ 1205 AN 1187-13		1052310													1052305	MMT45 MMT87 FMT45 FMT87 ERT90
N = 1 	19,05	5,56	12,7	5,2		1187-90					2305343				2304503							MMT45 FMT45

¹⁾ Winkel am Werkstück = 43,5° ²⁾ Schruppgeometrie mit 2-fach Beschichtung
¹⁾ Angle on workpiece = 43,5° **LC280TT** Roughing geometry with double coating
 Sortenbeschreibung/-bezeichnung und ISO-Code ab Seite 22
 Description/Designation of grades and ISO-Code starting page 22

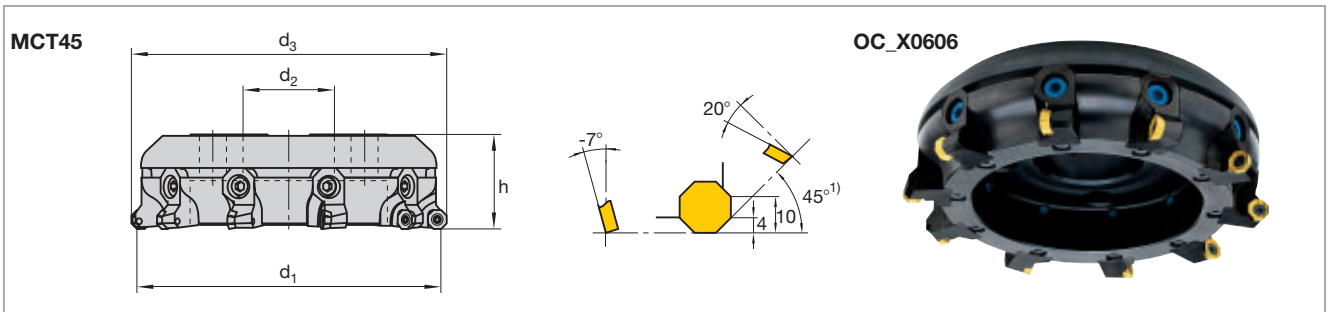

d ₁	d ₃	h	d ₂	z	Standard Ident No.	LMT-Code	Eng fine z	Eng fine Ident No.	LMT-Code
100	108	63	32	6	1028400				
125	133	63	40	6	1028401		8	1028411	
160	168	63	40	8	1028402		12	1028412	
200	208	63	60	10	1028403		14	1028413	
250	258	63	60	12	1028404		18	1028414	
315	323	80	60	16	1028405		22	1028415	
400	408	80	60	18	1028406		26	1028416	
500	508	80	60	22	1028407		32	1028417	

OC_X0606						
Ident No.						
1028077	1045777	1048344	2141985	2146544	1045713	2147491

N = Anzahl der Schneidkanten N = Number of cutting edges							Schneidstoffsorten Cutting materials											Für Fräser For cutter						
	l	s	d	d ₁	b/r	ISO-Code Cat-No.	LC240T	LC240S	LC230F	LC225T	LC225S	LC630T	LW240	LW225	LC440T	LC444W	LC610E		LC610T	LC610W	LC610A	LW610	LC603Z	Cat-No.
 N = 8	16	6,35	16	5,8	0,5	OCKX 0606 AD-TR	1054003		1068004		1054001			1054002	1054000									FCT45 FCTXX MCT45
	16	6,35	16	5,8	0,5	OCKX 0606 AD-TRT breite Schneidkantenfase wide land	1055731 ²⁾				1054012							1055011						
 N = 2		6,35	16	5,8		RCKX 1606 MO-TR	1068433				1068431		1068432	1068430				1068435				1068434		FCT45 FCTXX MCT45
		6,35	16	5,8		RCKX 1606 MO-TRT breite Schneidkantenfase wide land	1055730 ²⁾				1068460							1068464						
 N = 2		6,35	16	5,8		XCKX1606ZDR-TR	1055677	1068010			1055676		1055674	1055673				1055678				1055675		FCT45 MCT45

¹⁾ Winkel am Werkstück = 43°
¹⁾ Angle on workpiece = 43°

²⁾ **LC280TT** Schruppgeometrie mit 2-fach Beschichtung
Roughing geometry with double coating

Schnittwertempfehlungen ab Seite 94
Cutting data recommendations starting page 94

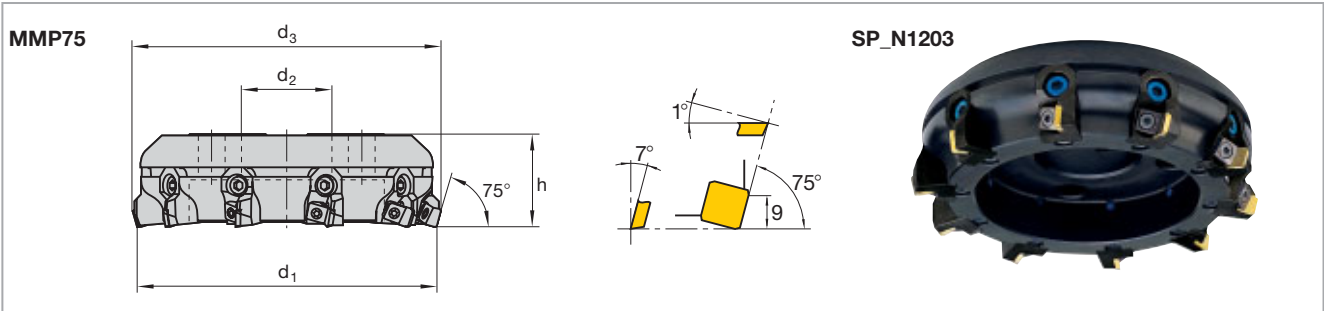

d ₁	d ₃	h	d ₂	Standard		LMT-Code	Eng fine		LMT-Code
				z	Ident No.		z	Ident No.	
100	105	63	32	6	1028180	MMP75 S12.100AN			
125	130	63	40	6	1028181	MMP75 S12.125AN	8	1028191	MMP75 S12.125AN-F
160	165	63	40	8	1028182	MMP75 S12.160AN	12	1028192	MMP75 S12.160AN-F
200	205	63	60	10	1028183	MMP75 S12.200AN	14	1028193	MMP75 S12.200AN-F
250	255	63	60	12	1028184	MMP75 S12.250AN	18	1028194	MMP75 S12.250AN-F
315	320	80	60	16	1028185	MMP75 S12.315AN	22	1028195	MMP75 S12.315AN-F
400	405	80	60	18	1028186	MMP75 S12.400AN	26	1028196	MMP75 S12.400AN-F
500	505	80	60	22	1028187	MMP75 S12.500AN	32	1028197	MMP75 S12.500AN-F

SP_N1203							
Ident No.							
1028042	2337584	1045181	1048427	2141985	2146544	1045713	2147491

N = Anzahl der Schneidkanten N = Number of cutting edges							Schneidstoffsorten Cutting materials										Für Fräser For cutter Cat-No.		
	l	s	d	d ₁	b/r	ISO-Code	LC240T	LC230F	LC225T	LC225S	LW225	LC440T	LC444W	LC610E	LC610T	LC610T		LC610A	LW610
 N = 4	12,7	3,18	12,7			SPAN 1203EDSR				●	●								
	12,7	3,18	12,7			SPKN 1203EDER								●					
	12,7	3,18	12,7			SPKN 1203EDSR	●	●	●	●	●				●				
 N = 4	12,7	3,18	12,7			SPKR 1203EDSR	●	●		●									

Sortenbeschreibung/-bezeichnung und ISO-Code ab Seite 22
Description/Designation of grades and ISO-Code starting page 22

Schnittwertempfehlungen ab Seite 94
Cutting data recommendations starting page 94

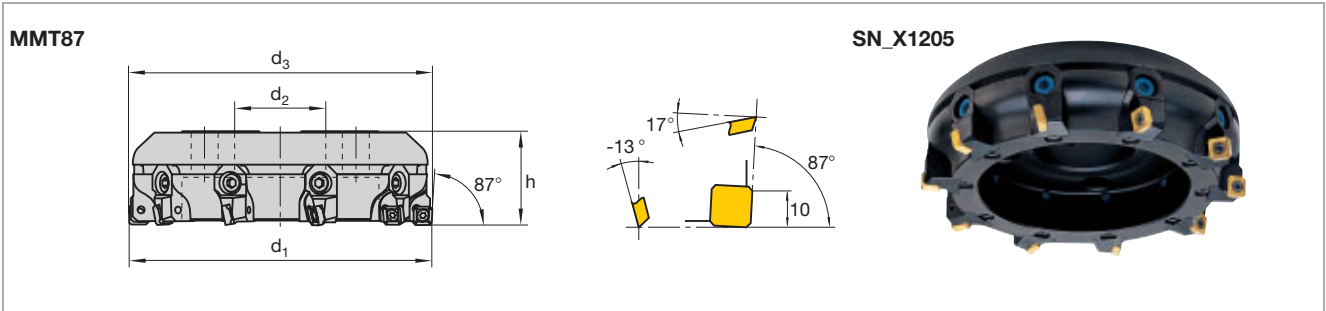

d ₁	d ₃	h	d ₂	Standard		LMT-Code	Eng fine		LMT-Code
				z	Ident No.		z	Ident No.	
100	101	63	32	6	1028220	MMT87 S12.100AN			
125	126	63	40	6	1028221	MMT87 S12.125AN	8	1028231	MMT87 S12.125AN-F
160	161	63	40	8	1028222	MMT87 S12.160AN	12	1028232	MMT87 S12.160AN-F
200	201	63	60	10	1028223	MMT87 S12.200AN	14	1028233	MMT87 S12.200AN-F
250	251	63	60	12	1028224	MMT87 S12.250AN	18	1028234	MMT87 S12.250AN-F
315	316	80	60	16	1028225	MMT87 S12.315AN	22	1028235	MMT87 S12.315AN-F
400	401	80	60	18	1028226	MMT87 S12.400AN	26	1028236	MMT87 S12.400AN-F
500	501	80	60	22	1028227	MMT87 S12.500AN	32	1028237	MMT87 S12.500AN-F

SN_X1205						
Ident No.						
1028052	1045123	1048344	2141985	2146544	1045713	2147491

N = Anzahl der Schneidkanten N = Number of cutting edges	Schneidstoffsorten Cutting materials											Für Fräser For cutter											
	l	s	d	d ₁	b/r	ISO-Code Cat-No.	LC240T	LC240S	LC230F	LC225T	LC225S		LC630T	LW240	LW225	LC440T	LC444W	LC610E	LC610T	LC610W	LC610A	LW610	LC603Z
 N = 4	12,7	5,56		5,2	2	SNKX 1205 AN 1187-10	1052301	1052230	1068007	1052315	1052228		1052238	1052232			1052234	1052339			1052236		MMT45 MMT87 FMT45 FMT87 EBTX ERT90 FRT90
 N = 4	12,7	5,56		5,2	2	SNKX 1205 AN-TR 1187-10 TR SNKX 1205 AN-TT	1052248	1052245		1052239	1052237		1052243	1052241			1052251				1052249		MMT45 MMT87 FMT45 FMT87 EBTX ERT90 FRT90
 N = 4	12,7	5,44		5,2	2	SNKX 1205 AN-T 1187-12 breite Schneidkantenfase wide land	1052303	1052258	1068008	1052314	1052256		1052252	1052250			1052309				1052254		MMT45 MMT87 FMT45 FMT87 EBTX ERT90 FRT90
 N = 8	12,7	5,56		5,2	2	SNKQ 1205 AN 1187-13		1052310													1052305		MMT45 MMT87 FMT45 FMT87 ERT90

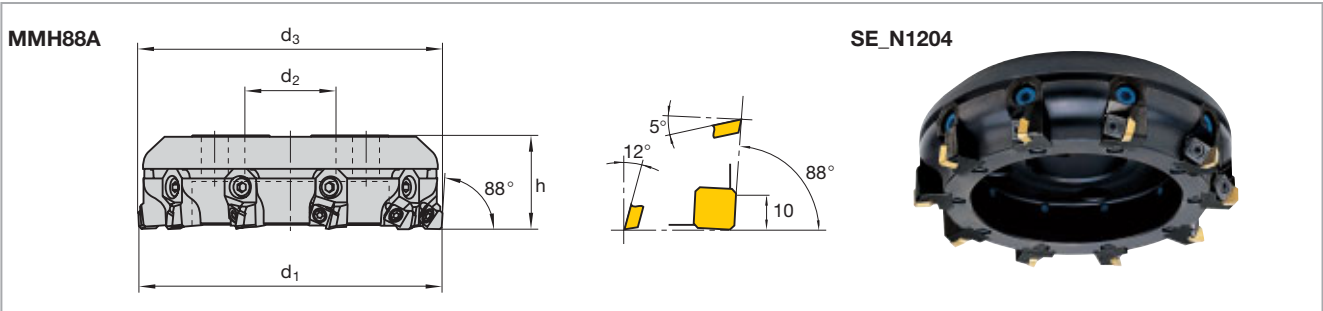

d ₁	d ₃	h	d ₂	Standard		LMT-Code	Eng fine		LMT-Code
				z	Ident No.		z	Ident No.	
100	101	63	32	6	1028200	MMH88A S12.100AN			
125	126	63	40	6	1028201	MMH88A S12.125AN	8	1028211	MMH88A S12.125AN-F
160	161	63	40	8	1028202	MMH88A S12.160AN	12	1028212	MMH88A S12.160AN-F
200	201	63	60	10	1028203	MMH88A S12.200AN	14	1028213	MMH88A S12.200AN-F
250	251	63	60	12	1028204	MMH88A S12.250AN	18	1028214	MMH88A S12.250AN-F
315	316	80	60	16	1028205	MMH88A S12.315AN	22	1028215	MMH88A S12.315AN-F
400	401	80	60	18	1028206	MMH88A S12.400AN	26	1028216	MMH88A S12.400AN-F
500	501	80	60	22	1028207	MMH88A S12.500AN	32	1028217	MMH88A S12.500AN-F

SE_N1204							
Ident No.							
1028073	2337584	1045181	1048427	2141985	2146544	1045713	2147491

N = Anzahl der Schneidkanten N = Number of cutting edges							Schneidstoffsorten Cutting materials										Für Fräser For cutter		
	l	s	d	d ₁	b/r	ISO-Code	LC240T	LC230F	LC225T	LC225S	LW225	LC440T	LC444W	LC610E	LC610T	LC610T	LC610A	LW610	Cat-No.
 N = 4	12,7	4,76	12,7		1,4	SEKN 1204AFEN								●					MMH45A S12
	12,7	4,76	12,7		1,4	SEKN 1204AFSN	●	●	●	●	●			●	●				
 N = 4	12,7	4,76	12,7		1,4	SEKR 1204AFSN	●	●	●	●	●	●							MMH45A S12
 N = 4	12,7	4,76	12,7		1,4	SEKR 1204AFSN-BM							●						MMH45A S12

Sortenbeschreibung/-bezeichnung und ISO-Code ab Seite 22
Description/Designation of grades and ISO-Code starting page 22

Schnittwertempfehlungen ab Seite 94
Cutting data recommendations starting page 94

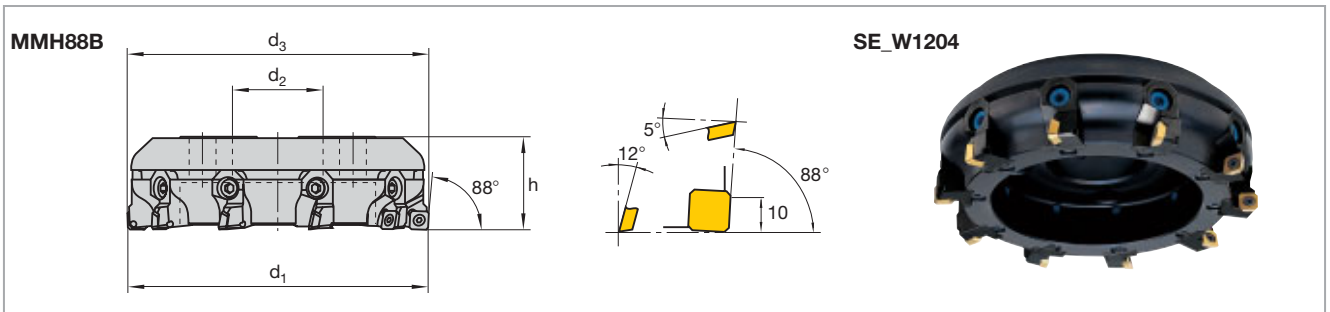

d ₁	d ₃	h	d ₂	z	Standard Ident No.	LMT-Code	Eng fine z	Eng fine Ident No.	LMT-Code
100	101	63	32	6	1028370	MMH88B S12.100AN			
125	126	63	40	6	1028371	MMH88B S12.125AN	8	1028381	MMH88B S12.125AN-F
160	161	63	40	8	1028372	MMH88B S12.160AN	12	1028382	MMH88B S12.160AN-F
200	201	63	60	10	1028373	MMH88B S12.200AN	14	1028383	MMH88B S12.200AN-F
250	251	63	60	12	1028374	MMH88B S12.250AN	18	1028384	MMH88B S12.250AN-F
315	316	80	60	16	1028375	MMH88B S12.315AN	22	1028385	MMH88B S12.315AN-F
400	401	80	60	18	1028376	MMH88B S12.400AN	26	1028386	MMH88B S12.400AN-F
500	501	80	60	22	1028377	MMH88B S12.500AN	32	1028387	MMH88B S12.500AN-F

SE_W1204						
Ident No.						
1028053	1045777	1048344	2141985	2146544	1045713	2147491

N = Anzahl der Schneidkanten N = Number of cutting edges	Schneidstoffsorten Cutting materials											Für Fräser For cutter Cat-No.							
	l	s	d	d ₁	b/r	ISO-Code	LC240T	LC230F	LC225T	LC225S	LW225		LC440T	LC444W	LC610E	LC610T	LC610A	LW610	
 N = 4	12,7	4,76	12,7	5,5		SEHT 1204AFEN						●							MMH45B S12
	12,7	4,76	12,7	5,5		SEKT 1204AFSN	●	●		●	●								
 N = 4	12,7	4,76	12,7	5,5		SEKW 1204AFEN								●	●				MMH45B S12
	12,7	4,76	12,7	5,5		SEKW 1204AFSN	●	●	●	●	●				●				
 N = 4	12,7	4,76	12,7	5,5		SEHT 1204AFFN-ALC										●	●	●	MMH45B S12
 N = 4	12,7	4,76	12,7	5,5		SEHT 1204AFSN-BM							●						MMH45B S12

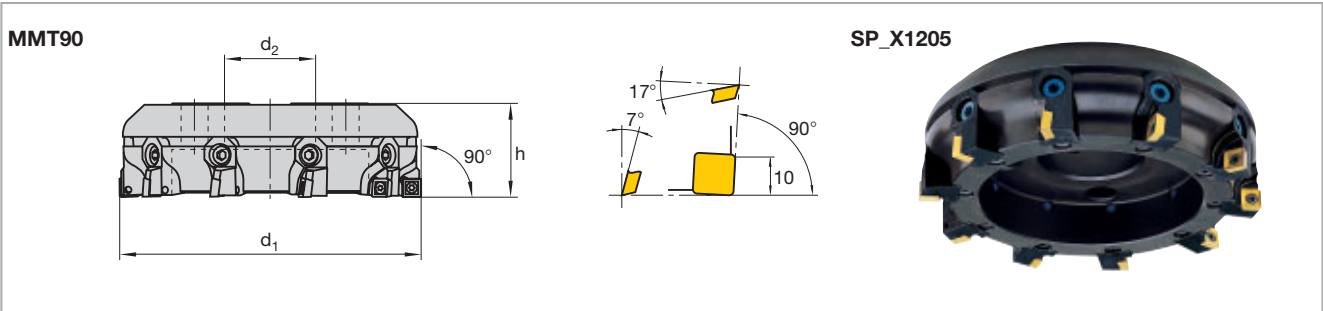

d ₁	h	d ₂	z	Standard Ident No.	LMT-Code	z	Eng fine Ident No.	LMT-Code
100	63	32	6	1028280	MMT90 S12.100AN			
125	63	40	6	1028281	MMT90 S12.125AN	8	1028291	MMT90 S12.125AN-F
160	63	40	8	1028282	MMT90 S12.160AN	12	1028292	MMT90 S12.160AN-F
200	63	60	10	1028283	MMT90 S12.200AN	14	1028293	MMT90 S12.200AN-F
250	63	60	12	1028284	MMT90 S12.250AN	18	1028294	MMT90 S12.250AN-F
315	80	60	16	1028285	MMT90 S12.315AN	22	1028295	MMT90 S12.315AN-F
400	80	60	18	1028286	MMT90 S12.400AN	26	1028296	MMT90 S12.400AN-F
500	80	60	22	1028287	MMT90 S12.500AN	32	1028297	MMT90 S12.500AN-F

SP_X1205					
Ident No.					
1028055	1045123	1048344	2141985	2146544	1045713 2147491

N = Anzahl der Schneidkanten N = Number of cutting edges	Schneidstoffsorten Cutting materials										Für Fräser For cutter												
	l	s	d	d ₁	b/r	ISO-Code Cat-No.	LC240T	LC240S	LC230F	LC225T		LC225S	LC630T	LW240	LW225	LC440T	LC444W	LC610E	LC610T	LC610W	LC610A	LW610	LC603Z
 N = 4	12,7	5,56		5,2	0,8	SPKX 120508 1187-15	1052247	1052246			1052244			1052240					1052659			1052242	

Sortenbeschreibung/-bezeichnung und ISO-Code ab Seite 22
Description/Designation of grades and ISO-Code starting page 22

Schnittwertempfehlungen ab Seite 94
Cutting data recommendations starting page 94

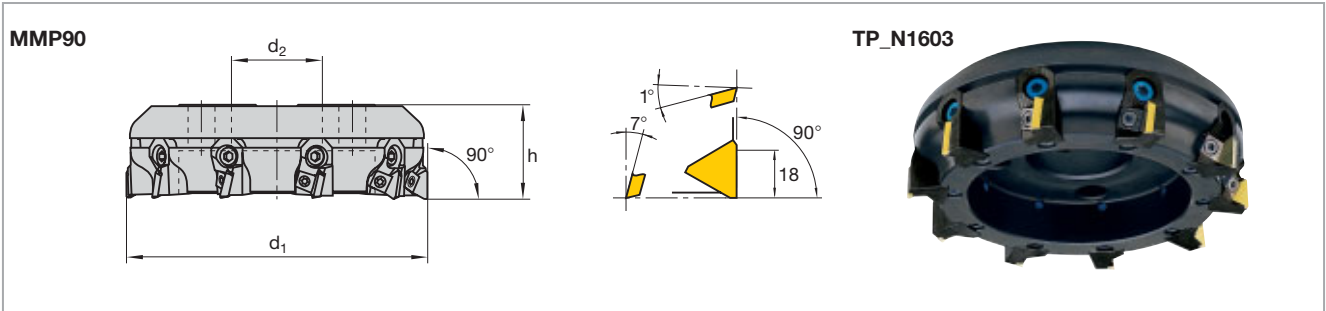

d ₁	h	d ₂	Standard		LMT-Code	Eng fine		LMT-Code
			z	Ident No.		z	Ident No.	
100	63	32	6	1028240	MMP90 T16.100AN	8	1028251	MMP90 T16.125AN-F
125	63	40	6	1028241	MMP90 T16.125AN	12	1028252	MMP90 T16.160AN-F
160	63	40	8	1028242	MMP90 T16.160AN	14	1028253	MMP90 T16.200AN-F
200	63	60	10	1028243	MMP90 T16.200AN	18	1028254	MMP90 T16.250AN-F
250	63	60	12	1028244	MMP90 T16.250AN	22	1028255	MMP90 T16.315AN-F
315	80	60	16	1028245	MMP90 T16.315AN	26	1028256	MMP90 T16.400AN-F
400	80	60	18	1028246	MMP90 T16.400AN	32	1028257	MMP90 T16.500AN-F
500	80	60	22	1028247	MMP90 T16.500AN			

TP_N1603							
Ident No.							
1028046	2337584	1045181	1048427	2141985	2146544	1045713	2147491

N = Anzahl der Schneidkanten N = Number of cutting edges							Schneidstoffsorten Cutting materials										Für Fräser For cutter Cat-No.				
	l	s	d	d ₁	b/r	ISO-Code	LC240T	LC230F	LC225T	LC225S	LW225	LC440T	LC444W	LC610E	LC610T	LC610A		LW610			
 N = 3	16,5	3,18	9,52			TPKN 1603PDER									●						MMP90 T16
	16,5	3,18	9,52			TPKN 1603PDSR	●	●	●	●	●										

Sortenbeschreibung/-bezeichnung und ISO-Code ab Seite 22
 Description/Designation of grades and ISO-Code starting page 22

Schnittwertempfehlungen ab Seite 94
 Cutting data recommendations starting page 94

MMP90

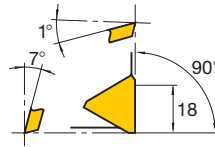
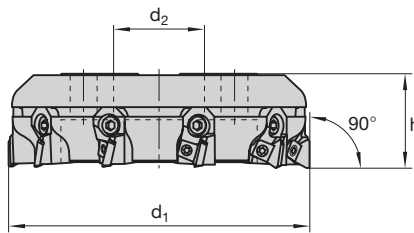

TP_N2204



d ₁	h	d ₂	Standard		LMT-Code	Eng fine		LMT-Code
			z	Ident No.		z	Ident No.	
100	63	32	6	1028260	MMP90 T22.100AN			
125	63	40	6	1028261	MMP90 T22.125AN	8	1028271	MMP90 T22.125AN-F
160	63	40	8	1028262	MMP90 T22.160AN	12	1028272	MMP90 T22.160AN-F
200	63	60	10	1028263	MMP90 T22.200AN	14	1028273	MMP90 T22.200AN-F
250	63	60	12	1028264	MMP90 T22.250AN	18	1028274	MMP90 T22.250AN-F
315	80	60	16	1028265	MMP90 T22.315AN	22	1028275	MMP90 T22.315AN-F
400	80	60	18	1028266	MMP90 T22.400AN	26	1028276	MMP90 T22.400AN-F
500	80	60	22	1028267	MMP90 T22.500AN	32	1028277	MMP90 T22.500AN-F

TP_N2204

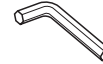
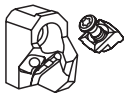

Ident No.

1028047 2337584 1045181 1048427 2141985 2146544 1045713 2147491





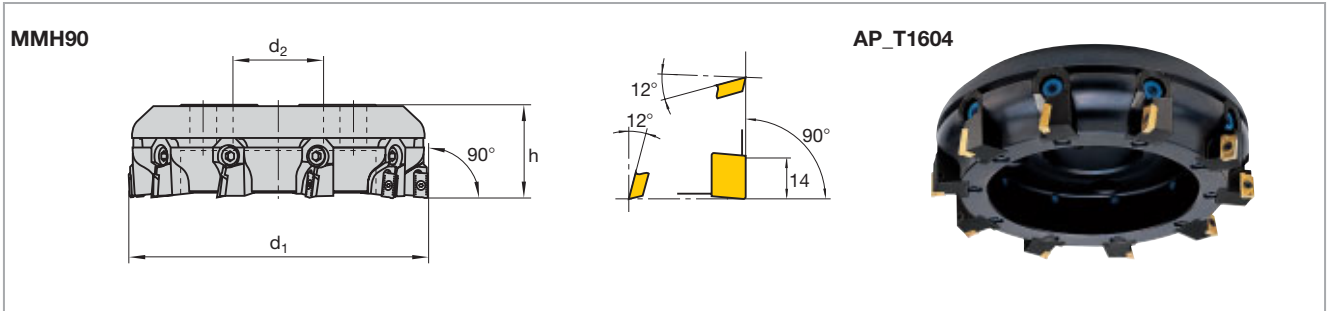

N = Anzahl der Schneidkanten N = Number of cutting edges						ISO-Code	Schneidstoffsorten Cutting materials										Für Fräser For cutter	Cat-No.	
	l	s	d	d ₁	b/r		LC240T	LC230F	LC225T	LC225S	LW225	LC440T	LC444W	LC610E	LC610T	LC610T			LC610A
 N = 3	22	4,76	12,7			TPKN 2204PDER													MMP90 T22
	22	4,76	12,7			TPKN 2204PDSR	●	●	●	●	●			●					

Sortenbeschreibung/-bezeichnung und ISO-Code ab Seite 22
Description/Designation of grades and ISO-Code starting page 22

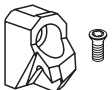
Schnittwertempfehlungen ab Seite 94
Cutting data recommendations starting page 94



d ₁	h	d ₂	Standard		LMT-Code	Eng fine		LMT-Code
			z	Ident No.		z	Ident No.	
100	63	32	6	1028320	MMH90 A16.100AN			
125	63	40	6	1028321	MMH90 A16.125AN	8	1028331	MMH90 A16.125AN-F
160	63	40	8	1028322	MMH90 A16.160AN	12	1028332	MMH90 A16.160AN-F
200	63	60	10	1028323	MMH90 A16.200AN	14	1028333	MMH90 A16.200AN-F
250	63	60	12	1028324	MMH90 A16.250AN	18	1028334	MMH90 A16.250AN-F
315	80	60	16	1028325	MMH90 A16.315AN	22	1028335	MMH90 A16.315AN-F
400	80	60	18	1028326	MMH90 A16.400AN	26	1028336	MMH90 A16.400AN-F
500	80	60	22	1028327	MMH90 A16.500AN	32	1028337	MMH90 A16.500AN-F

AP_T1604						
Ident No.						
						
1028054	1045131	1048335	2141985	2146544	1045713	2147491

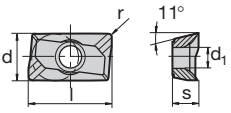
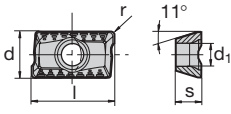
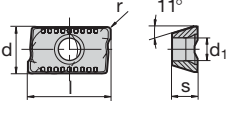



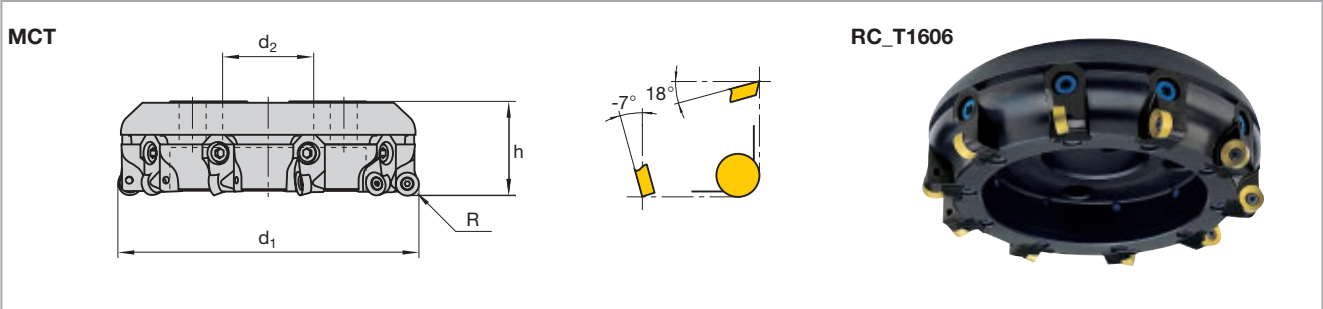

N = Anzahl der Schneidkanten N = Number of cutting edges							Schneidstoffsorten Cutting materials										Für Fräser For cutter Cat-No.			
	l	s	d	d ₁	b/r	ISO-Code	LC240T	LC230F	LC225T	LC225S	LW225	LC440T	LC444W	LC610E	LC610T	LC610T		LC610A	LW610	
 N = 2	17,3	5,26	9,52	4,5	0,8	APHT 1604PDRF-ALC														MMH90 A16
 N = 2	17,3	5,26	9,52	4,5	0,8	APKT 1604PDSR-BM								●						MMH90 A16
 N = 2	17,3	5,26	9,52	4,5	0,8	APKT 1604PDSR-BP	●	●	●	●	●	●			●					MMH90 A16
	17,3	5,26	9,52	4,5	1,6	APKT 160416SR-BP					●									
	17,3	5,26	9,52	4,5	2,4	APKT 160424SR-BP					●									
	17,3	5,26	9,52	4,5	3,2	APKT 160432SR-BP					●									

Sortenbeschreibung/-bezeichnung und ISO-Code ab Seite 22
Description/Designation of grades and ISO-Code starting page 22

Schnittwertempfehlungen ab Seite 94
Cutting data recommendations starting page 94



d ₁	h	d ₂	Standard		LMT-Code	Eng fine		LMT-Code
			z	Ident No.		z	Ident No.	
100	63	32	6	1028340	MCT R16.100AN			
125	63	40	6	1028341	MCT R16.125AN	8	1028351	MCT R16.125AN-F
160	63	40	8	1028342	MCT R16.160AN	12	1028352	MCT R16.160AN-F
200	63	60	10	1028343	MCT R16.200AN	14	1028353	MCT R16.200AN-F
250	63	60	12	1028344	MCT R16.250AN	18	1028354	MCT R16.250AN-F
315	80	60	16	1028345	MCT R16.315AN	22	1028355	MCT R16.315AN-F
400	80	60	18	1028346	MCT R16.400AN	26	1028356	MCT R16.400AN-F
500	80	60	22	1028347	MCT R16.500AN	32	1028357	MCT R16.500AN-F

RC_T1606					
Ident No.					
					
1028056	1045177	1048344	2141985	2146544	1045713

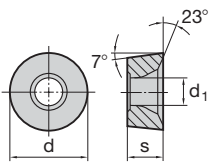
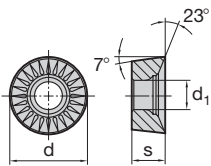
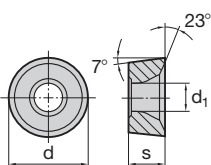
N = Anzahl der Schneidkanten N = Number of cutting edges						ISO-Code Cat-No.	Schneidstoffsorten Cutting materials Ident No.										Für Fräser For cutter Cat-No.						
	l	s	d	d ₁	b/r		LC240T	LC240S	LC230F	LC225T	LC225S	LC630T	LW240	LW225	LC440T	LC444W		LC610E	LC610T	LC610W	LC610A	LW610	LC603Z
		6,35	16	5,8		RCHX 1606 MO 1195-14	1068379	1068415		1068414		1068411	1068407				1068383			1068413	1055755		ECT FCT MCT
		6,35	12	5,2		RCHX 1606 MO-TR 1195-14 TR	1069506		1069501	1069503		1069505	1069502				1069509			1069508	1069504		ECT FCT MCT
		6,35	16	5,8		RCHX 1606 MO-T 1195-24 breite Schneidkantenfase wide land	1068389	1068417		1068416		1068420	1068419				2345947			1068421			ECT FCT MCT

Sortenbeschreibung/-bezeichnung und ISO-Code ab Seite 22
Description/Designation of grades and ISO-Code starting page 22

Schnittwertempfehlungen ab Seite 94
Cutting data recommendations starting page 94



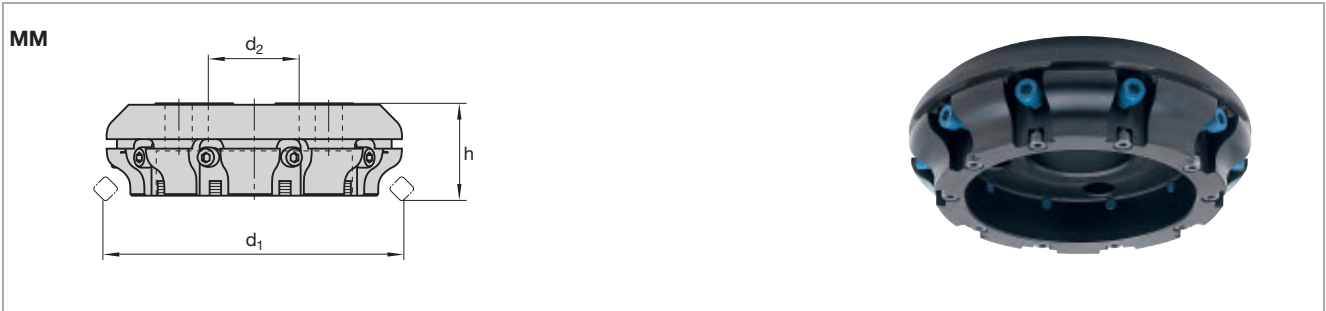

d ₁	h	d ₂	Standard		Eng fine		max.		LMT-Code
			z	Ident No.	LMT-Code	z	Ident No.	LMT-Code	
100	63	32	6	1028001	MM 100AN				
125	63	40	6	1028002	MM 125AN	8	1028010	MM 125AN-F	9 1028060 MM 125AN-EF
160	63	40	8	1028003	MM 160AN	12	1028011	MM 160AN-F	13 1028061 MM 160AN-EF
200	63	60	10	1028004	MM 200AN	14	1028012	MM 200AN-F	18 1028062 MM 200AN-EF
250	63	60	12	1028005	MM 250AN	18	1028013	MM 250AN-F	24 1028063 MM 250AN-EF
315	80	60	16	1028006	MM 315AN	22	1028014	MM 315AN-F	32 1028064 MM 315AN-EF
400	80	60	18	1028007	MM 400AN	26	1028015	MM 400AN-F	40 1028065 MM 400AN-EF
500	80	60	22	1028008	MM 500AN	32	1028016	MM 500AN-F	52 1028066 MM 500AN-EF

Ident No.			
2141985	2146544	1045713	2147491

N = Anzahl der Schneidkanten N = Number of cutting edges							Schneidstoffsorten Cutting materials											Für Fräser For cutter						
	l	s	d	d ₁	b/r	ISO-Code Cat-No.	LC240T	LC240S	LC230F	LC225T	LC225S	LC630T	LW240	LW225	LC440T	LC444W	LC610E		LC610T	LC610W	LC610A	LW610	LC603Z	Cat-No.
		6,35	16	5,8		RCMX 1606 MO-T 1195-28 breite Schneidkantenfase wide land	1068429				1068427		1068428	1068426										ECT FCT MCT
		6,35	16	5,8		RCKT 1606 MO-TT	1055732 ¹⁾																	ECT FCT MCT

¹⁾ LC280TT Schruppgeometrie mit 2-fach Beschichtung
Roughing geometry with double coating

Technische Hinweise Technical hints

Multi-Mill Kassetten Multi-Mill cartridges

Spannhebelklemmung Lever clamping system							
45°			75°	88°	90°		75°
SE_N1203 45°	SE_N1204 45°	SE_N1504 45°	SP_N1203 75°	SE_N1204 88°	TP_N1603 90°	TP_N2204 90°	SP_W1204 75°
Ident No.							
1028072	1028040	1028041	1028042	1028073	1028046	1028047	1028075

Ident No.			
2337584	1045181	1048427	1045777 1045123

Lochklemmung Centre screw clamping							
45°			87°	88°	90°		rund round
SE_W1204 45°	SN_X1205 45°	OC_X0606 45°	SN_X1205 87°	SE_W1204 88°	SP_X1205 90°	AP_T1604 90°	RC_T1606
Ident No.							
1028051	1028050	1028077	1028052	1028053	1028055	1028054	1028056

Ident No.	
1 1045777	1045123
2 1045123	1048344

Auswahl weiterer Formen und Geometrien auf Anfrage
Selection of other geometries upon request

Technische Hinweise Technical hints

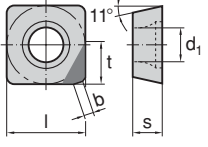
N = Anzahl der Schneidkanten N = Number of cutting edges	l	s	d	d ₁	b	t	ISO-Code Cat.-No.	PKD 1 PKD 2 CBN				
 <p>N = 4</p>	12,7	4,76		5,5	1,4	2,5	SPGW 1204 EDR	1055021				
						5		1055022				
						2,5		1055023				

Multi-Mill Montage- und Einstellanleitung des Fräses Multi-Mill assembly and adjustment instructions for the cutters

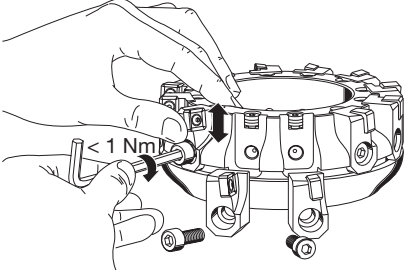
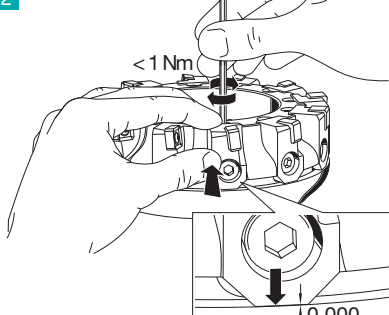
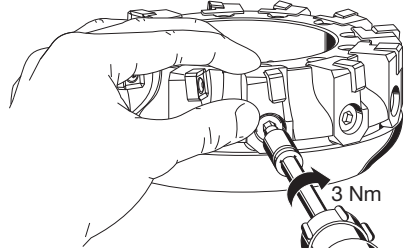
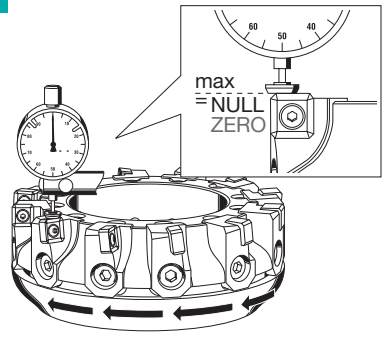
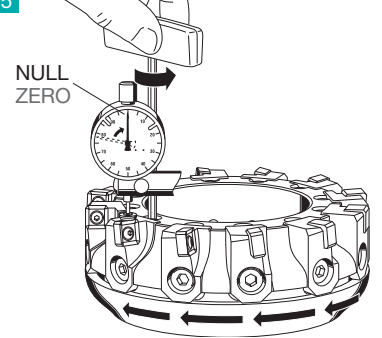
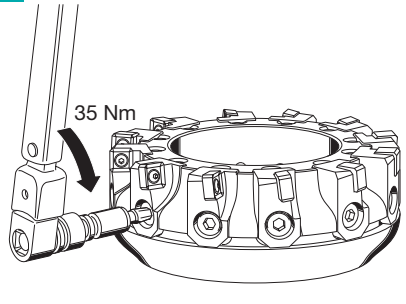
<p>1</p>  <p>< 1 Nm</p>	<p>2</p>  <p>< 1 Nm</p> <p>0,000</p>	<p>3</p>  <p>3 Nm</p>
<p>Kassetten einsetzen Insert cartridge</p>	<p>Kassetten auf Festanschlag bringen Cartridge to fixed back stop</p>	<p>Vorspannen Pre-load</p>
<p>4</p>  <p>max = NULL ZERO</p>	<p>5</p>  <p>NULL ZERO</p>	<p>6</p>  <p>35 Nm</p>
<p>Messen aller Schneiden (höchste Schneide = 0) Measure all inserts (highest = zero)</p>	<p>Einstellen Adjust</p>	<p>Festschrauben Clamp</p>

Werkstoff	Material	Rm/UTS (N/mm ²)	HM-Sorten ¹⁾ Carbide Grade	Vorschub pro Zahn Feed per tooth mm			Leistungsfaktor Efficiency factor LF cm ³ /min · kW
				0,1	0,3	0,5	
				Schnittgeschwindigkeit Cutting speed v _c = m/min			
Unlegierter Baustahl	Plain carbon steel	≤ 700	LC225S	220	180	140	24
Automatenstahl	Free cutting steel	≤ 700	LC225S	220	180	140	22
Baustahl	Structural alloy steel	500 – 950	LC225S	180	150	120	20
Vergütungsstahl, mittelfest	Heat-treatable steel, medium strength	500 – 950	LC225S	160	130	100	18
Stahlguss	Cast steel	≤ 950	LC225S	160	130	100	18
Einsatzstahl	Case hardening steel	≤ 950	LC225S	160	130	100	18
Rost- und säurebeständiger Stahl, ferritisch, martensitisch	Stainless steel, ferritic, martensitic	500 – 950	LC225S	170	140	–	16
Vergütungsstahl, hochfest	Heat-treatable steel, high strength	950 – 1400	LC240T (LC225S)	150	120	–	16
Nitrierstahl, vergütet	Nitriding steel	950 – 1400	LC240T (LC225S)	150	120	–	16
Werkzeugstahl	Tool steel	950 – 1400	LC240T (LC225S) CBN	150 500	120	–	14
Rost- und säurebeständiger Stahl, austenitisch	Stainless steel, austenitic	500 – 950	LC440T	250–350 60 ²⁾	250–350 60 ²⁾	–	18
Grauguss	Grey cast iron	100 – 400 (120 – 260 HB)	LC610T	210	160	130	30
Legierter Grauguss	Alloyed grey cast iron	150 – 250 (160 – 230 HB)	LC610T CBN	160 1200	130	100	22
Sphäroguss	Nodular cast iron	400 – 800 (120 – 310 HB)	LC610T	160	130	100	24
Temperguss	Malleable cast iron	350 – 700 (150 – 280 HB)	LC610T	210	160	120	24
Rein-Metalle, weich	Pure metals, soft	≤ 500	LC225S	500	350	250	50
Aluminium-Legierungen, langspanend	Aluminium alloys, long chipping	≤ 550	LW610 PKD	1200 2000	900	700	60
Aluminium-Legierungen, kurzspanend	Aluminium alloys, short chipping	≤ 400	LW610 PKD	400 1500	250	200	55
Kupfer-Legierungen, langspanend	Copper alloys, long chipping	300 – 700	LC225S	500	350	250	50
Kupfer-Legierungen, kurzspanend	Copper alloys, short chipping	≤ 500	LC225S	300	250	200	35
Magnesium-Legierungen	Magnesium alloys	150 – 300	LW610	400	300	200	50
Thermoplaste	Thermoplastics	40 – 70	LW610	250	250	250	70
Duroplaste	Duroplastics	20 – 40	LW610	200	200	200	35
Titan-Legierungen, mittelfest	Titanium alloys, medium strength	≤ 950	LW610	100	80	–	20
Titan-Legierungen, hochfest	Titanium alloys, high strength	900 – 1400	LW610 LW630	60	40	–	16
Nickelbasis-Legierungen, mittelfest	Nickel based alloys, medium strength	≤ 950	LC225S	80	60	–	18
Hochwarmfeste Nickel-Basis-Legierungen	Heat resistant nickel based alloys, high strength	900 – 1400	LC240T	50	30	–	15
Hartguss	Chilled cast iron	300 – 600 HB	LC240T CBN	40 500	30	–	24

¹⁾ Weitere HM-Sortenempfehlungen Seite XX

¹⁾ Further carbide recommendations page XX

²⁾ Beim Fräsen mit Kühlschmiermittel

²⁾ When milling with coolant

Technische Hinweise Technical hints

Empfohlene maximale Zahnvorschübe f_z (mm) bei
 $a_e = 0,75 \times d_1$ (Gleichlaufräsen)
 Recommended maximum feed per tooth rates f_z (mm) for
 $a_e = 0,75 \times d_1$ (Climb milling)

	SE_N1203	SE_N1204	SE_W1204	SE_N1504	SN_X1205	OC_X0606	SP_N1203	SN_X1205
	45°	45°	45°	45°	45°	45°	75°	87°
a_p max	5,5	5,5	5,5	9	7	3/8	9	10
	0,25 – 0,3	0,3 – 0,4	0,3 – 0,4	0,3 – 0,4	0,4 – 0,5	0,4 – 0,45	0,25 – 0,3	0,3 – 0,35
	0,15	0,15	0,15	0,15	0,15	0,2	0,15	0,15
	0,4	0,5	0,5	0,5	0,6	0,6	0,4	0,4
	0,3	0,4	0,4	0,4	0,5	0,5	0,3	0,3
	0,2	0,25	0,25	0,25	0,3	0,3	0,2	–
	SE_N1204	SE_W1204	SP_X1205	TP_N1603	TP_N2204	AP_T1604	RC_T1606	
	88°	88°	90°	90°	90°	90°	rund round shape	
a_p max	10	10	10	14	20	14	8	
	0,2 – 0,3	0,2 – 0,3	0,2 – 0,3	0,15 – 0,2	0,2 – 0,3	0,2 – 0,25	0,4 – 0,5	
	0,15	0,15	–	–	–	0,15	0,2	
	0,4	0,4	0,35	0,3	0,4	0,4	0,6	
	0,3	0,3	0,3	0,25	0,3	0,3	0,5	
	–	–	–	–	–	–	0,3	

Formeln Formulas

Drehzahl Speed n (min⁻¹):

$$n = \frac{v_c \cdot 1000}{\pi \cdot d_1}$$

Schnittgeschwindigkeit Cutting speed

$$v_c \text{ (m/min): } v_c = \frac{n \cdot \pi \cdot d_1}{1000}$$

v_c = Schnittgeschwindigkeit Cutting speed (m/min)

n = Drehzahl (min⁻¹) Speed (min⁻¹)

d_1 = Fräser-Durchmesser (mm) Cutter dia. (mm)

v_f = Vorschubgeschwindigkeit Feed rate (mm/min)

f_z = Vorschub pro Zahn Feed per tooth (mm)

P_e = Antriebsleistung Drive power

Z_{eff} = effektive Zähnezahl Effective number of teeth

Q = Spanvolumen Chip volume (cm³/min)

a_e = Schnittbreite Width of cut (mm)

a_p = Schnitttiefe Depth of cut (mm)

LF = Leistungsfaktor Efficiency factor (cm³/min/kW)

Vorschubgeschwindigkeit Feed rate

v_f (mm/min):

$$v_f = f_z \cdot Z_{eff} \cdot n$$

Vorschub pro Zahn Feed per tooth

$$f_z \text{ (mm): } f_z = \frac{v_f}{Z_{eff} \cdot n}$$

Spanvolumen Chip volume Q (cm³/min):

$$Q = \frac{a_e \cdot a_p \cdot v_f}{1000}$$

Antriebsleistung Drive power

$$P_e \text{ (kW): } P_e = \frac{Q}{LF}$$



KIENINGER 3D HSC MK 125 10 R-D

Messerkopfsysteme

Milling Cutter Systems

1D-System	
1D-System	
1D-Plan- und Eckfräser	98
1D Face and Angle Milling Cutter	
Schneidplatten	100
Inserts	
Ersatzteile und Zubehör	101
Accessories and Spares	
Einstellanweisungen	102
Setting Instructions	
2D-Mini-System	
2D-Mini-System	
2D-Mini-Plan- und Eckfräser	104
2D-Mini Face and Angle Milling Cutter	
Schneidplatten	104
Inserts	
Ersatzteile und Zubehör	105
Accessories and Spares	
Einstellanweisungen	105
Setting Instructions	
2D/3D-System	
2D/3D-System	
2D/3D Planfräser	106
2D/3D Face Milling Cutter	
2D/3D Eckfräser	108
2D/3D Angle Milling Cutter	
Schneidplatten	110
Inserts	
Ersatzteile und Zubehör	111
Accessories and Spares	
Einstellanweisungen	114
Setting Instructions	
Werkzeugservice	116
Tooling Service	
Sonderlösungen, Anwendungsbeispiele	117
Special solutions, Application Examples	



**1D-Einstellung
der Schneiden axial**

**1D-insert
adjustment axial**

	d_1	z	h	d_2	IKZ	LMT-Code	Ident. No.
Ø 63-80 	63	4	102	–	–	1D-MK 063 04 R HSK-A63	K200463
	63	4	102	–	x	1D-MK 063 04 R HSK-A63 IK	K200464
	80	6	102	–	–	1D-MK 080 06 R HSK-A63	K200460
	80	6	102	–	x	1D-MK 080 06 R HSK-A63 IK	K200459
Ø 80-125 	80	4	52	27	x	1D-MK 080 06 R DIN 6358 IK	K280824
	100	6	52	32	x	1D-MK 100 06 R DIN 6358 IK	K280825
	100	8	52	32	x	1D-MK 100 08 R DIN 6358 IK	K200465
	125	8	65	40	x	1D-MK 125 08 R DIN 6358 IK	K280803
	125	10	65	40	x	1D-MK 125 10 R DIN 6358 IK	K280823
Ø 160-250 	160	10	63	40	–	1D-MK 160 10 R DIN 2079	K280819
	160	10	63	40	x	1D-MK 160 10 R DIN 2079 IK	K280820
	160	12	63	40	–	1D-MK 160 12 R DIN 2079	K200461
	160	12	63	40	x	1D-MK 160 12 R DIN 2079 IK	K200462
	200	12	63	60	–	1D-MK 200 12 R DIN 2079	K280821
	200	12	63	60	x	1D-MK 200 12 R DIN 2079 IK	K280822
	200	16	63	60	–	1D-MK 200 16 R DIN 2079	K280810
	200	16	63	60	x	1D-MK 200 16 R DIN 2079 IK	K280811
	250	16	63	60	–	1D-MK 250 16 R DIN 2079	K280817
	250	16	63	60	x	1D-MK 250 16 R DIN 2079 IK	K280818
	250	20	63	60	–	1D-MK 250 20 R DIN 2079	K280812
	250	20	63	60	x	1D-MK 250 20 R DIN 2079 IK	K280813

Linksausführung und weitere Werkzeugaufnahmen auf Anfrage
L/h version and additional tool arbors on request

Wendeschneidplatten siehe Seite 100
Indexable Inserts see page 100

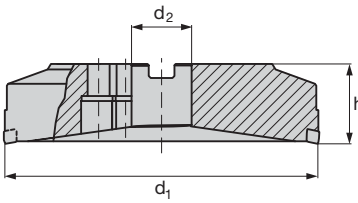
	d ₁	z	h	d ₂	IKZ	LMT-Code	Ident. No.
	315	20	80	60	–	1D-MK 315 20 R DIN 2079	K280815
	315	24	80	60	–	1D-MK 315 24 R DIN 2079	K280806
	400	24	80	60	–	1D-MK 400 24 R DIN 2079	K280809
	400	32	80	60	–	1D-MK 400 32 R DIN 2079	K280805

Alle Abbildungen zeigen Planausführung
All images in face milling version

Linksausführung und weitere Werkzeugaufnahmen auf Anfrage
L/h version and additional tool arbors on request

Wendeschneidplatten siehe Seite 100
Indexable Inserts see page 100

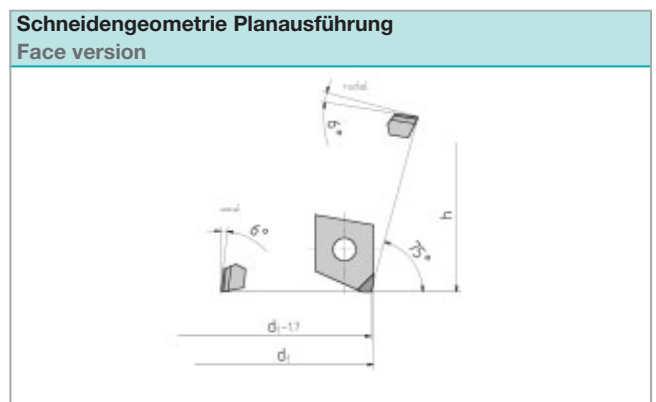
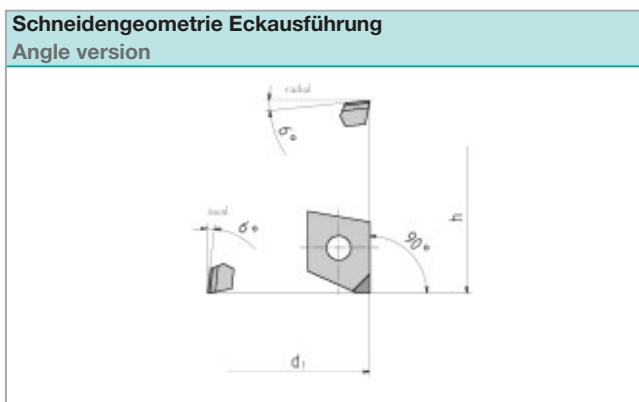

Einsatz als Plan- oder Eckfräser wird durch Auswahl der Schneidplatte bestimmt
Eighter contour or face milling just by selecting the requested geometry

Kühlmittelzufuhr (IKZ) – Grundkörper Aluminium Coolant Supply (IKZ) – Body material aluminium

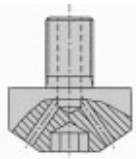
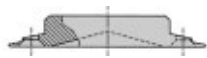
	MK-Durchmesser d [mm] MC diameter d [mm]		Innere Kühlmittelzufuhr, IKZ Internal coolant supply, IKZ	Ident. No.
	80	●	Fräseranzugsschraube FAS 080 27 A pull-stud FAS 080 27 A	K119384
	100	●	Fräseranzugsschraube FAS 100 32 A pull-stud FAS 100 32 A	K119385
	125	●	Fräseranzugsschraube FAS 125 40 A pull-stud FAS 125 40 A	K119386
	160	●	Kühlmittelscheibe KVD 160 40 A coolant disk KVD 160 40 A	K119398
	200	●	Kühlmittelscheibe KVD 200 60 A coolant disk KVD 200 60 A	K119381
	250		Kühlmittelscheibe KVD 200 60 A coolant disk KVD 200 60 A	
	315	○	Kühlmittelscheibe KVD 315 60 A coolant disk KVD 315 60 A	K203857
	400	○	Kühlmittelscheibe KVD 400 60 A coolant disk KVD 400 60 A	K203858

● = im Lieferumfang enthalten ○ = auf Anfrage
included in delivery on request

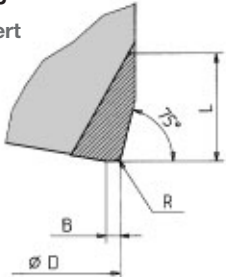
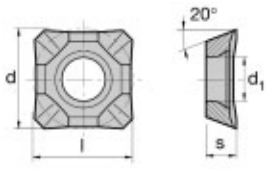
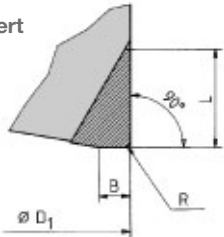
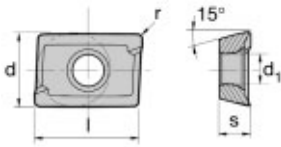
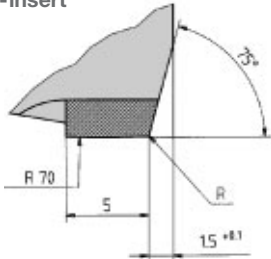









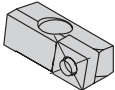

	B	t	y	r	LMT-Code	Ident. No.
Plan-WSP Face-insert 	1,0	3,0	6°	0,2	IT 01 RP DP*	K126192
	1,0	6,0	6°	0,4	IT 02 RP DP*	K126191
	0,7	–	6°	0,2	IT 03 RP LW 610*	K126189
	1,0	6,0	6°	0,4	IT 04 RP DP	K126193
	0,7	–	6°	0,2	IT 05 RP LW 610	K280903
	1,0	3,0	6°	0,4	IT 06 RP DP	K281173
	l	d	d₁	s	LMT-Code	Ident. No.
	12,7	12,7	5,5	4,76	SEHT 12 04 AFFN-ALC VA819	K203838
	12,7	12,7	5,5	4,76	SEHT 12 04 AFFN HB10F	K203695
Eck-WSP Angle-insert 	B	t	y	r	LMT-Code	Ident. No.
	1,6	3,0	6°	0,2	IT 01 RE DP*	K126205
	1,6	6,0	6°	0,4	IT 02 RE DP*	K126204
	1,6	–	6°	0,2	IT 03 RE LW 610*	K126202
	1,6	6,0	6°	0,4	IT 04 RE DP	K126188
	1,6	–	6°	0,2	IT 05 RE LW 610	K260134
	1,6	3,0	6°	0,4	IT 06 RE DP	K281170
	l	d	d₁	s	LMT-Code	Ident. No.
	12,7	9,52	4,0	3,97	ADHT 12 T3 06 FR-ALC VA819	K203837
	12,7	9,52	4,0	3,97	ADHT 12 T3 06 FR HB10F	K203694
Schlicht-WSP Wiper-insert 	B	t	y	r	LMT-Code	Ident. No.
	–	5,0	6	0,2	IT 01 RV DP*	K126201
	–	5,0	6	0,2	IT 02 RV DP	K201952

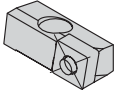

* Auslaufprodukt, Klemmhalter für kurze Schneidplatten wird durch optimierte lange Ausführung ersetzt.

* Phase-out product, short style cartridge will be replaced by the optimized long style.

Weitere Schneidstoffe auf Anfrage
Additional qualities on request

Sortenbeschreibung/-bezeichnung ab Seite 22
Description/Designation of grades starting page 22

Halter/Klemmstück/Schraube Schneidplatte Insert-Holder/clamping piece/fixing screw/insert			
Halter Insert-Holder	Klemmstück Clamping piece	Schraube Klemmstück Fixing screw	WSP insert
K 119392 MKH 1 NR 01 1D-WSP-Halter (kurz*), radial 0° x axial 0° 1D-Insert-Holder (short), radial 0° x axial 0° 	K119407 MKL 1 R 01 Klemmstück (kurz) clamping piece (short) 	K119393 BS 5 R 02 Befestigungsschraube M 5 fixing screw M 5  K119319 4 x 100 Sechskantschlüssel mit Quergriff Hexagon service wrench with T-handle 	Plan-WSP Face insert: IT 01 RP IT 02 RP IT 03 RP Eck-WSP Angle insert: IT 01 RE IT 02 RE IT 03 RE Schlicht-WSP Wiper insert: IT 01 RV
K 119397 MKH 1 NR 02 1D-WSP-Halter (lang*), radial 0° x axial 0° 1D-Insert-Holder (long), radial 0° x axial 0° 	K280576 MKL 1 R 02 Klemmstück (lang) clamping piece (long) 	K280711 BS 5 R 03 Befestigungsschraube M 5 fixing screw M 5  K119319 4 x 100 Sechskantschlüssel mit Quergriff Hexagon service wrench with T-handle 	Plan-WSP Face insert: IT 04 RP IT 05 RP IT 06 RP Eck-WSP Angle insert: IT 04 RE IT 05 RE IT 06 RE Schlicht-WSP Wiper insert: IT 02 RV
K202578 MKH 1 PR 01 (45°) 1D-WSP-Halter, radial -3° x axial 15° 1D-Insert-Holder, radial -3° x axial 15°  Halter für ISO-WSP Insert-Holder for ISO-inserts	K202587 MKL 1 R 03 Klemmstück (ISO) clamping piece (ISO) 	K280711 BS 5 R 03 Befestigungsschraube M 5 fixing screw M 5  K119319 4 x 100 Sechskantschlüssel mit Quergriff Hexagon service wrench with T-handle 	Plan-WSP Face insert: SEHT 12 04 AFFN SEHT 12 04 AFFN
K202904 MKH 1 ER 01 (90°) 1D-WSP-Halter, radial -3° x axial 13° 1D-Insert-Holder, radial -3° x axial 13°  Halter für ISO-WSP Insert-Holder for ISO-inserts			Eck-WSP Angle insert: ADHT 12 T3 06 FR ADHT 12 T3 06 FR

Zubehör für 1D-WSP-Halter Accessoires for 1D-Insert-Holder	
 K119391 ST 5 R 01B Stellschraube axial setting screw axial	 K119394 BS 6 R 01 Befestigungsschraube M 6 fixing screw M 6

Wendeschneidplatten siehe Seite 100
Indexable Inserts see page 100

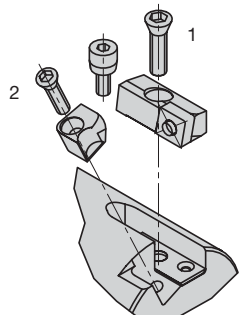
Schrauben-Anzugsmomente [Nm] Recommended torque [Nm]	Schraube Screw	Schraubendreher Screwdriver	Anzugsmoment Torques setting
	1	SW 4	Voreinstellung pre-adjustment 4,0 Nm
	2	SW 4	Feineinstellung fine-tuning 10,0 Nm
			4,0 Nm

Optimierung der Oberfläche durch Schrupp/Schlicht-Einstellung mit Standard-Wechselplatten Optimize of the surface through roughing/finishing adjustment with standard inserts

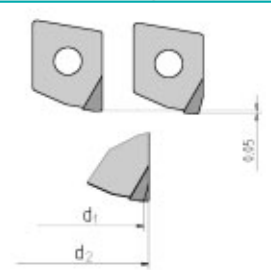
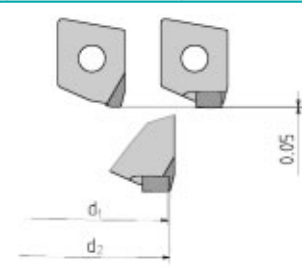
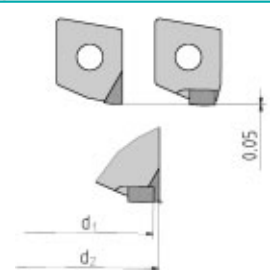
mit Wechselplatten Eck-Plan exchangeable inserts angle-face	mit Wechselplatten Eck-Breitschicht exchangeable inserts angle-wiper blade	mit Wechselplatten Plan-Breitschicht exchangeable inserts face-wiper blade
		

Verstellbereich in einer Dimension Adjustable in axial direction only

	<p>Axial einstellbar auf Nennmaß. Nachschliff nicht kompensierbar. Einstellung nur auf Planlauf möglich. Der Rundlauf über die Schneide beträgt 0,05 mm. Die Werkzeuge werden werkseitig eingestellt und ausgewuchtet.</p> <p>Axial adjustable to nom. measure. Regrinding cannot be compensated. Runout = 0.05 mm. Tools are shipped adjusted and balanced.</p>
---	--

MK-Durchmesser MC diameter d [mm]	Grundkörper Body	Zähnezahl No. of teeth z	Gewicht Weight [kg]	Max. Schnittgeschwindigkeit cutting speed v _c [m/min]	Drehzahl speed n [1/min]
63	Stahl steel	4	2.1	6283	20000
80	Stahl steel	6	2.7	6283	20000
80	Aluminium aluminium	6	0.7	6283	20000
100	Aluminium aluminium	6	1.0	6283	20000
100	Aluminium aluminium	8	1.1	6283	20000
125	Aluminium aluminium	8	1.8	6283	16000
125	Aluminium aluminium	10	1.9	6283	16000
160*	Aluminium aluminium	10	2.9	6283	12500
160*	Aluminium aluminium	12	3.0	6283	12500
200*	Aluminium aluminium	12	4.4	6283	10000
200*	Aluminium aluminium	16	4.6	6283	10000
250*	Aluminium aluminium	16	6.9	6283	8000
250*	Aluminium aluminium	20	7.1	6283	8000
315*	Aluminium aluminium	20	13.0	6283	6350
315*	Aluminium aluminium	24	13.2	6283	6350
400*	Aluminium aluminium	24	21.5	6283	5000
400*	Aluminium aluminium	32	21.9	6283	5000

* Gewichtsangaben ohne Kühlmittelscheibe
Weight without coolant disc



Die 1D (1-dimensionale) Einstellbarkeit bei Messerköpfen für die HSC-Bearbeitung (High Speed Cutting) heißt, dass der Planlauf (axial) der Schneidplatten zueinander einstellbar ist. Der Rundlauf (radial) und die Planfase sind voreingestellt und nicht justierbar. Bei der Einstellung sind die Grundkörpermaterialien des Messerkopfes zu beachten (Aluminium – oder Stahlausführung). Die Messerköpfe werden bei Auslieferung von KIENINGER in Rund- und Planlauf eingestellt und ausgewuchtet.

The 1D (1-dimensional) adjustability on milling cutters for HSC-operations (HSC-High Speed Cutting) means, that the inserts' axial run-out can be individually adjusted and set. The radial insert run-out and the wiper-edge are preset and cannot be adjusted. When adjusting the milling cutter, the basic cutter materials have to be taken into consideration (aluminium – or steel type). KIENINGER supplies the milling cutters balanced, preadjusted and set in both axial and radial directions.

Grundeinstellung der Schneiden:

1. Einschrauben des Wechselplattenhalters (2) mit der zuvor montierten Schneidplatte (1). Die Befestigungsschraube (3) mit einem Drehmoment von 4 Nm anziehen (Bild 1)
2. Klemmstück (5) einschrauben und mit einem Drehmoment von 4 Nm anziehen (Bild 2)
3. Die Axialstellschraube (4) in den MK-Grundkörper eindrehen, bis sie am Wechselplattenhalter (2) anliegt (Bild 3)
4. Die zuvor genannten Arbeitsschritte wiederholen, bis der Grundkörper komplett bestückt ist.

Feineinstellung der Schneiden:

1. Alle Schneiden durch Eindrehen der Axial-Stellschraube (4) bis auf ca. 0,02 mm vor das Nennmaß einstellen (2)
2. Die Befestigungsschraube (3) des Wechselplattenhalters mit einem Drehmoment von 10 Nm festziehen (Bild 1)
3. Die Feineinstellung wird mit der Axial-Stellschraube (4) vorgenommen (Bild 3)

Wichtig: Hierzu keine Schraube mehr lösen

4. Nochmalige Kontrolle der Einstellung

Bitte beachten Sie, dass keine einzelnen Schneiden nachträglich gewechselt werden können. Sollte dies jedoch erforderlich sein, so ist der Messerkopf zu demontieren, zu reinigen und wieder neu einzustellen.

Beim Lösen der Befestigungsschraube (4 + 7) bitte Drehmomentschlüssel verwenden.

4 Nm = 35 in. lb.
10 Nm = 88 in. Lb.

Basic setting:

1. The cartridge (2) together with the previously installed insert (1) has to be screwed into the cutter body. Tighten the cartridge locking screw (3) with a torque of 4Nm (35 in. Lb), (picture 1).
2. Screw in the insert wedge (5) and tighten it with with 4 Nm torque (picture 2).
3. Screw in the axial adjusting screw (4) into the cutter body, until it touches the insert cartridge (2), (picture 3)
4. Continue the previously mentioned process steps, until the cutter body is completely loaded with inserts.

Fine tuning:

1. Tuning the axial adjusting screw (4) until all inserts have to been adjusted to approximately 0,02 mm (.0008“) below the nominal required setting height (picture 3). This provides for additional axial adjusting travel height if required.
2. The locking screw (4) for the insert cartridge has to be tightened with a 10 Nm (88 in. Lb.) torque (picture 1).
3. For fine tuning, use axial adjusting screw (4), (see picture 3).
4. Check the settings once again.

Important: Do not loosen screws again

Please note, inserts cannot be changed individually without adjustment. Should this still be necessary, the hardware has to be dismantled, cleaned and readjusted.

Use torque wrench when loosening the cartridge locking screws (4 + 7).

4 Nm = 35 in. lb.
10 Nm = 88 in. Lb.

2D-Einstellung der Schneiden: 2D-insert adjustment:		Eck-Einstellung Angle-adjustment		Plan-Einstellung Face-adjustment	
axial	axial				
radial	radial				

	d ₁	z	h	d ₂	LMT-Code	Ident. No.
Planfräser Ø 40 - 50 Face milling cutter 	40	3	40	44,8	2D-MINI P 040 03 R DIN 1835-25	K119777
	40	3	80	44,8	2D-MINI P 040 03 R HSK-A63	K119779
	50	4	40	54,8	2D-MINI P 050 04 R DIN 1835-25	K119763
	50	4	80	54,8	2D-MINI P 050 04 R HSK-A63	K119765
Eckfräser Ø 40 - 50 Angle milling cutter 	40	3	40	–	2D-MINI E 040 03 R DIN 1835-25	K119728
	40	3	80	–	2D-MINI E 040 03 R HSK-A63	K119730
	50	4	40	–	2D-MINI E 050 04 R DIN 1835-25	K119733
	50	4	80	–	2D-MINI E 050 04 R HSK-A63	K119735

2D-MINI-HSC-Messerkopf – Wendeschneidplatten 2D-MINI-HSC-Milling Cutter – Indexable Inserts

	d	t	y	r	LMT-Code	Ident. No.
	9,525	3,0	0	0,4	SDGW 09 T3 04 DP	K125016
	9,525	–	–	0,4	SDGW 09 T3 04 LW 610	K125015
	9,525	2,5	0	–	SDGW T3 EDR 1 DP	K125009
	9,525	–	–	–	SDGW T3 EDR LW 610	K201060
	9,525	3,5	0	0,4	CDGW 09 T3 04 DP	K123872
	9,525	–	–	0,4	CDGW 09 T3 04 LW 610	K180281
	9,525	3,0	0	–	CDGW 09 T3 PDR 1 DP	K123874
	9,525	–	–	–	CDGW 09 T3 PDR LW 610	K200536

Linksausführung und weitere Werkzeugaufnahmen auf Anfrage
L/h version and additional tool arbors on request

Weitere Schneidstoffe auf Anfrage
Additional qualities on request

Sortenbeschreibung/-bezeichnung ab Seite 22
Description/Designation of grades starting page 22

	Pos	LMT-Code	Ident. No.
	2	MKH 2 PR 02 2D-Käfigträger Plan (75°), radial 0° x axial 0° 2D-seat support (75°), radial 0° x axial 0°	K119402
	2	MKH 2 ER 02 2D-Käfigträger Eck (90°), radial 0° x axial 0° 2D-seat support (90°), radial 0° x axial 0°	K119405
	4	S 40 76 60 T 15, TORX-Befestigungsschraube für WSP T 15, TORX-fixing screw for Insert	K119602
	5	M 6 x 8, DIN 913 Stellschraube Radial setting screw radial	K103911
	6	ST 8 R 02C Stellschraube setting screw	K119411
	7	ST 8 R 01C Stellschraube Axial setting screw axial	K119412
	8	ST 5 R 02B Stellschraube Radial setting screw radial	K119413
		SW-SET-2D-MINI Schraubendreher-Set für 2D-MINI-HSC-MK screwdriver set for 2Dx-HSC-MK	K119332

Beschreibung der Schneideneinstellung Description of insert adjustment				
<p>Montage: Stellschraube (7) in den Grundkörper bis Zapfenanfang drehen. Stellschraube (8) in den Grundkörper ganz nach unten drehen. WSP-Träger mit montierter WSP in den Grundkörper montieren und Stellschraube (6) eindrehen.</p> <p>Voreinstellung: Durch Eindrehen von Stellschraube (5) und Ausdrehen von Stellschraube (8) Planfase und Durchmesser bis 0,02 mm unter Sollmaß einstellen. Durch Eindrehen von Stellschraube (7) Axialmaß bis 0,02 mm unter Sollmaß einstellen. Spannschraube (6) anlegen.</p> <p>Feineinstellung: Rundlauf durch Eindrehen von Stellschraube (5) und Ausdrehen von Stellschraube (8) einstellen. Planlauf durch Eindrehen Stellschraube (7) einstellen. Spannschraube (6) mit Drehmoment 10 Nm anziehen. Maße kontrollieren.</p>	<p>Mounting: Twist setting screw (7) up until start of pin into cutter body. Twist setting screw (8) down all the way to bottom of cutter body. Install seat support with mounted insert into cutter body. Screw-in setting screw (6).</p> <p>Pre-Adjustment: Wiper-edge and diameter adjustment up until 0,02 mm below nominal size by screwing-in setting screw (5) and screwing-out setting screw (8). Adjusting axial size up until 0,02 mm below nominal size by screwing-in setting screw (7). Position clamping screw (6).</p> <p>Fine-Tuning: Adjust concentricity by screwing-in setting screw (5) and screwing-out setting screw (8). Adjust axial runout by screwing-in setting screw (7). Tighten clamping screw (6) with a 10 Nm torque. Check measures.</p>			

Schneideneinstellung Insert adjustment	Verstellbereich in zwei Dimensionen Adjustably in two dimensions
	<p>1 axial (h) ±0,5 mm</p> <p>2 radial (d_r) ±1,0 mm</p> <p>Einstellgenauigkeit: ±0,003 mm</p> <p>Setting accuracy</p>

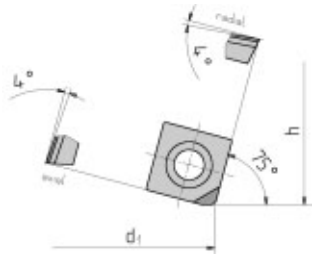
		
2D-Einstellung der Schneiden 2D-insert adjustment	3D-Einstellung der Schneiden 3D-insert adjustment	Schneidengeometrie für 2D/3D-Planfräser Cutting geometry for 2D/3D face milling cutter
axial axial	axial axial	
radial radial	radial radial	
	Planfase wiper edge	

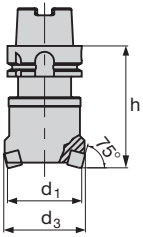
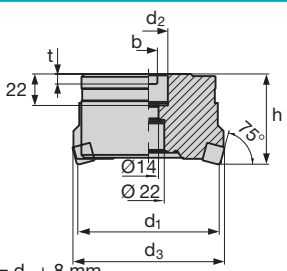
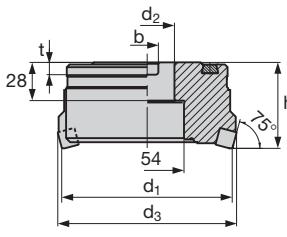
	d_1	z	h	d_2	d_4	b^{H11}	t^{H12}	LMT-Code	Ident. No.
Ø 63 - 80  Maß $d_3 = d_1 + 8 \text{ mm}$ Dimension $d_3 = d_1 + 8 \text{ mm}$	63	3	105,0	-	-	-	-	2D-MK-P 063 03 R HSK-A63	K119813
	63	3	105,0	-	-	-	-	3D-MK-P 063 03 R HSK-A63	K119701
	80	4	105,0	-	-	-	-	2D-MK-P 080 04 R HSK-A63	K119799
	80	4	105,0	-	-	-	-	3D-MK-P 080 04 R HSK-A63	K119705
Ø 100  Maß $d_3 = d_1 + 8 \text{ mm}$ Dimension $d_3 = d_1 + 8 \text{ mm}$	100	5	63,0	27	-	12,4	7,0	2D-MK-P 100 05 R DIN 6358	K119802
	100	5	63,0	27	-	12,4	7,0	3D-MK-P 100 05 R DIN 6358	K119693
	100	7	63,0	40	-	12,4	7,0	2D-MK-P 100 07 R DIN 6358	K119804
	100	7	63,0	27	-	12,4	7,0	3D-MK-P 100 07 R DIN 6358	K119695
Ø 125  Maß $d_3 = d_1 + 8 \text{ mm}$ Dimension $d_3 = d_1 + 8 \text{ mm}$	125	6	63,0	40	-	16,4	9,0	2D-MK-P 125 06 R DIN 6358	K119806
	125	6	63,0	40	-	16,4	9,0	3D-MK-P 125 06 R DIN 6358	K119697
	125	10	63,0	40	-	16,4	9,0	2D-MK-P 125 10 R DIN 6358	K119790
	125	10	63,0	40	-	16,4	9,0	3D-MK-P 125 10 R DIN 6358	K119699

Linksausführung und weitere Werkzeugaufnahmen auf Anfrage
L/h version and additional tool arbors on request

Innere Kühlmittelzufuhr (IKZ) auf Anfrage
Internal coolant supply on request

Wendeschneidplatten siehe Seite 110
Indexable Inserts see page 110

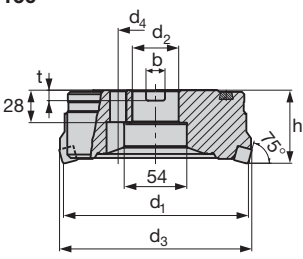
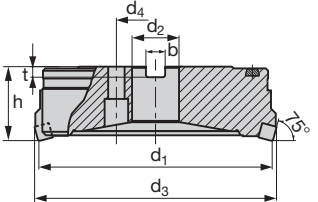
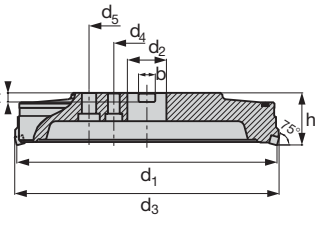
	d_1	z	h	d_2	d_4	b^{H11}	t^{H12}	LMT-Code	Ident. No.
Ø 160  <p>Maß $d_3 = d_1 + 8$ mm Dimension $d_3 = d_1 + 8$ mm</p>	160	8	63,0	40	66,7	16,4	9,0	2D-MK-P 160 08 R DIN 2079-40/6358	K119791
	160	8	63,0	40	66,7	16,4	9,0	3D-MK-P 160 08 R DIN 2079-40/6358	K119682
	160	12	63,0	40	66,7	16,4	9,0	2D-MK-P 160 12 R DIN 2079-40/6358	K119793
	160	12	63,0	40	66,7	16,4	9,0	3D-MK-P 160 12 R DIN 2079-40/6358	K119684
Ø 200 - 250  <p>Maß $d_3 = d_1 + 8$ mm Dimension $d_3 = d_1 + 8$ mm</p>	200	10	63,0	60	101,6	25,7	14,0	2D-MK-P 200 10 R DIN 2079-50	K119795
	200	10	63,0	60	101,6	25,7	14,0	3D-MK-P 200 10 R DIN 2079-50	K119686
	200	16	63,0	40	66,7	25,7	14,0	2D-MK-P 200 16 R DIN 2079-40	K119797
	200	16	63,0	40	66,7	25,7	14,0	3D-MK-P 200 16 R DIN 2079-40	K119688
	250	12	63,0	60	101,6	25,7	14,0	2D-MK-P 250 12 R DIN 2079-50	K119781
	250	12	63,0	60	101,6	25,7	14,0	3D-MK-P 250 12 R DIN 2079-50	K119681
	250	20	63,0	60	101,6	25,7	14,0	2D-MK-P 250 20 R DIN 2079-50	K119783
	250	20	63,0	60	101,6	25,7	14,0	3D-MK-P 250 20 R DIN 2079-50	K119674
Ø 315 - 400  <p>Maß $d_3 = d_1 + 8$ mm Dimension $d_3 = d_1 + 8$ mm</p>	315	18	80,0	60	101,6	25,7	14,0	2D-MK-P 315 18 R DIN 2079-50/60	K119785
	315	18	80,0	60	101,6	25,7	14,0	3D-MK-P 315 18 R DIN 2079-50/60	K119676
	315	24	80,0	60	101,6	25,7	14,0	2D-MK-P 315 24 R DIN 2079-50	K119787
	315	24	80,0	60	101,6	25,7	14,0	3D-MK-P 315 24 R DIN 2079-50	K119678
	400	24	80,0	60	101,6	25,7	14,0	2D-MK-P 400 24 R DIN 2079-50	K119789
	400	24	80,0	60	101,6	25,7	14,0	3D-MK-P 400 24 R DIN 2079-50/60	K119680

Linksausführung und weitere Werkzeugaufnahmen auf Anfrage
L/h version and additional tool arbors on request

Innere Kühlmittelzufuhr (IKZ) auf Anfrage
Internal coolant supply on request

Wendeschneidplatten siehe Seite 110
Indexable Inserts see page 110

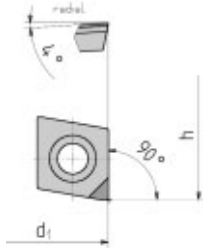
		
2D-Einstellung der Schneiden 2D-insert adjustment	3D-Einstellung der Schneiden 3D-insert adjustment	Schneidengeometrie für 2D/3D-Planfräser Cutting geometry for 2D/3D face milling cutter
axial axial	axial axial	
radial radial	radial radial	
	Planfase wiper edge	

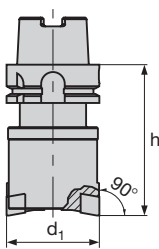
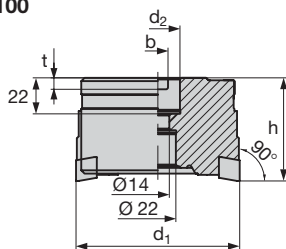
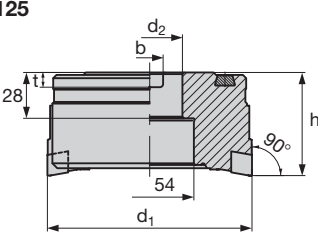
	d ₁	z	h	d ₂	d ₄	b ^{H11}	t ^{H12}	LMT-Code	Ident. No.
Ø 63 - 80 	63	3	96,5	-	-	-	-	2D-MK-E 063 03 R-DIN 69871-A40	K119768
	63	3	96,5	-	-	-	-	3D-MK-E 063 03 R DIN 69871-A40	K119666
	63	3	105,0	-	-	-	-	2D-MK-E 063 03 R HSK-A63	K119769
	63	3	105,0	-	-	-	-	3D-MK-E 063 03 R HSK-A63	K119667
	80	4	96,5	-	-	-	-	2D-MK-E 080 04 R DIN 69871-A40	K119754
	80	4	96,5	-	-	-	-	3D-MK-E 080 04 R DIN 69871-A40	K119670
	80	4	105,0	-	-	-	-	2D-MK-E 080 04 R HSK-A63	K119755
	80	4	105,0	-	-	-	-	3D-MK-E 080 04 R HSK-A63	K119671
Ø 100 	100	5	63,0	27	-	12,4	7,0	2D-MK-E 100 05 R DIN 6358	K119758
	100	5	63,0	27	-	12,4	7,0	3D-MK-E 100 05 R DIN 6358	K119656
	100	7	63,0	40	-	12,4	7,0	2D-MK-E 100 07 R DIN 6358	K119760
	100	7	63,0	27	-	12,4	7,0	3D-MK-E 100 07 R DIN 6358	K119658
Ø 125 	125	6	63,0	40	-	16,4	9,0	2D-MK-E 125 06 R DIN 6358	K119762
	125	6	63,0	40	-	16,4	9,0	3D-MK-E 125 06 R DIN 6358	K119660
	125	10	63,0	40	-	16,4	9,0	2D-MK-E 125 10 R DIN 6358	K119750
	125	10	63,0	40	-	16,4	9,0	3D-MK-E 125 10 R DIN 6358	K119662

Linksausführung und weitere Werkzeugaufnahmen auf Anfrage
L/h version and additional tool arbors on request

Innere Kühlmittelzufuhr (IKZ) auf Anfrage
Internal coolant supply on request

Wendeschneidplatten siehe Seite 110
Indexable Inserts see page 110

	d_1	z	h	d_2	d_4	b^{H11}	t^{H12}	LMT-Code	Ident. No.
Ø 160 	160	8	63,0	40	66,7	16,4	9,0	2D-MK-E 160 08 R DIN 2079-40/6358	K119752
	160	8	63,0	40	66,7	16,4	9,0	3D-MK-E 160 08 R DIN 2079-40/6358	K119663
	160	12	63,0	40	66,7	16,4	9,0	2D-MK-E 160 12 R DIN 2079-40/6358	K119745
	160	12	63,0	40	66,7	16,4	9,0	3D-MK-E 160 12 R DIN 2079-40/6358	K119647
Ø 200 - 250 	200	10	63,0	60	101,6	25,7	14,0	2D-MK-E 200 10 R DIN 2079-50	K119747
	200	10	63,0	60	101,6	25,7	14,0	3D-MK-E 200 10 R DIN 2079-50	K119649
	200	16	63,0	40	66,7	25,7	14,0	2D-MK-E 200 16 R DIN 2079-40	K119736
	200	16	63,0	40	66,7	25,7	14,0	3D-MK-E 200 16 R DIN 2079-40	K119651
	250	12	63,0	60	101,6	25,7	14,0	2D-MK-E 250 12 R DIN 2079-50	K119738
	250	12	63,0	60	101,6	25,7	14,0	3D-MK-E 250 12 R DIN 2079-50	K119653
	250	20	63,0	60	101,6	25,7	14,0	2D-MK-E 250 20 R DIN 2079-50	K119740
	250	20	63,0	60	101,6	25,7	14,0	3D-MK-E 250 20 R DIN 2079-50	K119638
Ø 315 - 400 	315	18	80,0	60	101,6	25,7	14,0	2D-MK-E 315 18 R DIN 2079-50/60	K119742
	315	18	80,0	60	101,6	25,7	14,0	3D-MK-E 315 18 R DIN 2079-50/60	K119640
	315	24	80,0	60	101,6	25,7	14,0	2D-MK-E 315 24 R DIN 2079-50	K200141
	315	24	80,0	60	101,6	25,7	14,0	3D-MK-E 315 24 R DIN 2079-50	K119642
	400	24	80,0	60	101,6	25,7	14,0	2D-MK-E 400 24 R DIN 2079-50/60	K119744
	400	24	80,0	60	101,6	25,7	14,0	3D-MK-E 400 24 R DIN 2079-50/60	K119643

Linksausführung und weitere Werkzeugaufnahmen auf Anfrage
L/h version and additional tool arbors on request

Innere Kühlmittelzufuhr (IKZ) auf Anfrage
Internal coolant supply on request

Wendeschneidplatten siehe Seite 110
Indexable Inserts see page 110

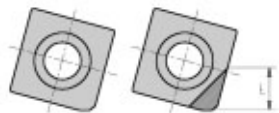
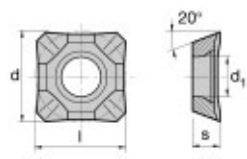
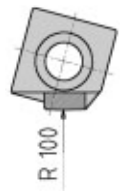
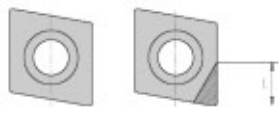
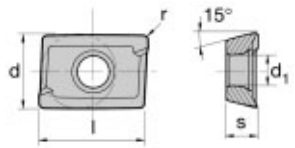
	d	t	y	r	LMT-Code	Ident. No.
Plan-WSP Face-insert 	12,7	2,5	0	–	SPGW 12 04 EDR1 DP	K123471
	12,7	5,0	0	–	SPGW 12 04 EDR2 DP	K123473
	12,7	5,0	8	–	SPGT 12 04 EDR2 DP	K123478
	12,7	10,5	0	–	SPGW 12 04 EDR3 DP	K123475
	12,7	2,5	0	–	SPGW 12 04 EDR1 BN	K123472
	12,7	–	0	–	SPGW 12 04 EDR LW 610	K123486
	12,7	2,5	0	–	SPGW 12 04 EDL1 DP	K123483
	12,7	5,0	0	–	SPGW 12 04 EDL2 DP	K123484
	12,7	–	0	–	SPGW 12 04 EDL LW 610	K123482
 <p>Plan-WSP (ISO), speziell für die Aluminiumbearbeitung. ISO-insert, especially for face milling of aluminium.</p>	l	d	d ₁	s	LMT-Code	Ident. No.
	12,7	12,7	5,5	4,76	SEHT 12 04 AFFN - ALC VA819	K203838
	12,7	12,7	5,5	4,76	SEHT 12 04 AFFN - HB10F	K203695
Schlicht-WSP Wiper insert 	d	t	y	r	LMT-Code	Ident. No.
	12,7	–	–	–	SPGW 12 04 R100 DP	K201446
Eck-WSP Angle insert 	d	t	y	r	LMT-Code	Ident. No.
	12,7	3,0	0	–	CPGW 12 04 PDR1 DP	K123455
	12,7	3,0	8	–	CPGT 12 04 PDR1 DP	K123460
	12,7	5,5	0	–	CPGW 12 04 PDR2 DP	K123457
	12,7	11,5	0	–	CPGW 12 04 PDR3 DP	K123459
	12,7	3,0	0	–	CPGW 12 04 PDR BN	K123456
	12,7	–	0	–	CPGW 12 04 PDR LW 610	K123452
	12,7	3,0	0	–	CPGW 12 04 PDL1 DP	K123467
	12,7	5,5	0	–	CPGW 12 04 PDL2 DP	K123468
	12,7	–	0	–	CPGW 12 04 PDL LW 610	K123466
 <p>Eck-WSP (ISO), speziell für die Aluminiumbearbeitung. ISO-insert, especially for contour milling aluminium.</p>	l	d	d ₁	s	LMT-Code	Ident. No.
	12,7	9,52	4,0	3,97	ADHT 12 T3 06 FR - ALC VA819	K203837
	12,7	9,52	4,0	3,97	ADHT 12 T3 06 FR - HB10F	K203694

PKD- und CBN-Wechselplatten sind um maximal 0,5 mm nachschleifbar. Die nachgeschliffenen Wechselplatten können bis zu diesem Nachschleifmaß ohne Änderung des Schneidplattenträgers wieder eingesetzt werden.
Maximum regrindability for the PCD-/CBN-inserts = 0.5 mm. Up to this regrinding measure the reground inserts can be remounted without any modifications on the insert segment.

Weitere Schneidstoffe auf Anfrage
Additional qualities on request

Von 3D auf 2D From 3D to 2D

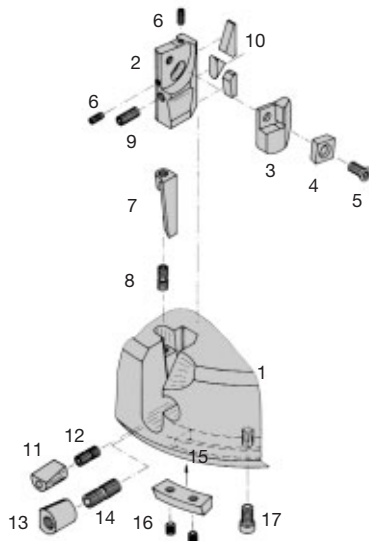

Das 3D-HSC-Messerkopfsystem kann durch Austausch des Käfigträgers (2) durch den 2D-Plattenträger in ein 2D-HSC-Messerkopfsystem gewandelt werden. Der Werkzeuggrundkörper und die übrigen Bauteile müssen dabei nicht gewechselt werden. Die Planfaseneinstellung der Schneidplatte entfällt damit. Die Funktionsweise der axialen und radialen Einstellung bleibt hingegen gleich.

By exchanging the seat support (2) with a 2D-seat support, the 3D-HSC-Milling Cutter System can be modified into a 2D-HSC-Milling Cutter System. Cutter body and any other parts do not have to be exchanged. Wiper-edge adjustment is inapplicable. Axial and radial adjustment procedures remain the same.

3D- Schneidkassetten-Sets Plan/Eck 3D-Cutting cartridge face/angle

K 119491

MK 3 SET P01

3D-Schneidkassette Plan (75°) komplett mit folgenden Einbauteilen:
3D-cutting cartridge (75°) complete with:

K119478 MKH 3 PR 01	K119471 KF 3 PR 01 für WSP for insert WSP: SP...12 04...	K119603 S 50 95 77	K 119427 ST 04 R 03A	K119429 ST 06 R 01A	K119456 MKL 3 N 01C
3D-Käfigträger Plan (75°) radial 4° x axial 4° 3D-Seat Support (75°) radial 4° x axial 4°	Schneidplattenkäfig P (75°) radial 4° x axial 4° segment for insert (75°) radial 4° x axial 4°	T20, TORX-Befestigungs- schraube für WSP T20, TORX-Fixing screw for Insert	Stellschraube für Schneidplattenkäfig Setting screw for Insert Segment	Stellschraube radial Setting screw radial	Stellkeil 3-teilig (Klemmstück) Clamping piece (3 parts)

K 119492











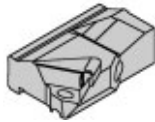

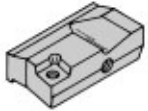

MK 3 SET E01

3D-Schneidkassette Eck (90°) komplett mit folgenden Einbauteilen:
3D-cutting cartridge (90°) complete with:

K119462 MKH 3 PR 01	K119470 KF 3 PR 01 für WSP for insert WSP: SP...12 04...	K119603 S 50 95 77	K 119427 ST 04 R 03A	K119429 ST 06 R 01A	K119456 MKL 3 N 01C
3D-Käfigträger Eck (90°) radial 4° x axial 0° 3D-Seat Support (90°) radial 4° x axial 0°	Schneidplattenkäfig E (90°) radial 4° x axial 0° segment for insert (90°) radial 4° x axial 0°	T20, TORX-Befestigungs- schraube für WSP T20, TORX-Fixing screw for Insert	Stellschraube für Schneidplattenkäfig Setting screw for Insert Segment	Stellschraube radial Setting screw radial	Stellkeil 3-teilig (Klemmstück) Clamping piece (3 parts)

Einbauteile für Linksausführung auf Anfrage

Accessories and spares for left hand version on request

2D-Schneidkassetten-Sets Plan/Eck 2D-Cutting cartridge sets face/angle					
K 119416  MKH2 SET PR01 für WSP: SP.. 12 04... for insert: SP.. 12 04...			K202592  MKH2 SET PR03 für WSP: SE.. 12 04... for insert: SE.. 12 04...		
2D-Schneidkassetten-Set Plan (75°), radial 0°, axial 0° komplett mit folgenden Einbauteilen: 2D-Cutting Cartridge, radial 0° x axial 0° complete with:			2D- Schneidkassetten-Set Plan (45°), radial -3°, axial 15° komplett mit folgenden Einbauteilen: 2D-Cutting Cartridge, radial -3°, axial 15° complete with:		
					
K119603 S 50 95 77 T 20 TORX Befestigungs- schraube für WSP Fixing screw for insert	K119429 ST 06 R 01A Stellschraube radial Setting Screw radial	K119456 MKL 3 N 01C Stellkeil 3-teilig (Klemmstück) Clamping piece (3 parts)	K119615 S 50 L 90 T 20 TORX Befestigungs- schraube für WSP Fixing screw for insert	K119429 ST 06 R 01A Stellschraube radial Setting screw radial	K119456 MKL 3 N 01C Stellkeil 3-teilig (Klemmstück) Clamping piece (3 parts)
K 119399  MKH2 SET ER01 für WSP: CP.. 12 04... for insert: CP.. 12 04...			K203780  MKH2 SET ER03 für WSP: AD.. 12 T3... for insert: AD.. 12 T3...		
2D- Schneidkassetten-Set Eck (90°), axial° komplett mit folgenden Einbauteilen: 2D-Cutting cartridge axial complete with:			2D- Schneidkassetten-Set Eck (90°), radial -3°, axial +13° komplett mit folgenden Einbauteilen: 2D-Cutting cartridge radial -3°, axial +13° complete with:		
					
K119603 S 50 95 77 T 20 TORX Befestigungs- schraube für WSP Fixing screw for insert	K119429 ST 06 R 01A Stellschraube radial Setting Screw radial	K119456 MKL 3 N 01C Stellkeil 3-teilig (Klemmstück) Clamping piece (3 parts)	K119615 S 50 L 90 T 20 TORX Befestigungs- schraube für WSP Fixing screw for insert	K119429 ST 06 R 01A Stellschraube radial Setting screw radial	K119456 MKL 3 N 01C Stellkeil 3-teilig (Klemmstück) Clamping piece (3 parts)

Einbauteile für Linksausführung auf Anfrage
Accessories and spares for left hand version on request

Einbauteile Spares					
Pos	Bezeichnung Designation	Ident. No.	Pos	Bezeichnung Designation	Ident. No.
1	Messerkopf-Grundkörper milling cutter body	Seite 106 page 106	15	HSC-Wuchtelement HSC-balancing weight	
2	3D-Käfigträger 3D-seat support	Seite 111 page 111		d = 100: WE 100 01	K119430
3	Schneidplattenkäfig segment for inserts	Seite 111 page 111		d = 125: WE 125 01	K119431
4	Wendeschneidplatten Indexable Inserts	Seite 110 page 110		d = 160: WE 160 01	K119432
5	S 50 95 77 TORX Befestigungsschraube WSP TORX fixing screw for insert	K119603		d = 200: WE 200 01	K119433
6	ST 04 R 03A Stellschraube für Schneidplattenkäfig setting screw for insert segment	K119427	16	ST 05 R 01D Stellschraube für Wuchtelement setting screw for balancing weight	K119425
7	MKL 3 R 01 Klemmstück (Radial-Stellkeil) clamping piece (radial wedge)	K119438	17	ZG 05 R 10 Zylinderschraube für Wuchtelement cheese head screw for balancing weight	K119423
8	DS 06 LR 13A Differential-Stellschraube radial differential setting screw radial	K119426			
9	ST 06 R01A Stellschraube radial setting screw radial	K119429			
10	MKL 3 N 01C Klemmstück (Stellkeil, 3-teilig) clamping piece (wedge, threepart)	K 119456			
11	MKL 3 N 01A Klemmstück (Axial-Stellkeil) clamping piece (axial wedge)	K119439			
12	DS 06 LR 20A Differential-Stellschraube axial differential setting screw axial	K119428			
13	MKL 3 R 02A Klemmstück (Spannkeil) clamping piece	K119442			
14	DS 08 LR 20A Differential-Spannschraube radial differential clamping screw radial	K119443			

Zubehör Accessoires					
	Bezeichnung Designation	Ident. No.		Bezeichnung Designation	Ident. No.
	T 20 TORX-Schraubendreher TORX-screwdriver	K119530		Schraubendreher-Set screwdriver-set	K119531
	Sechskant-Griffschlüssel hexagon key			Sechskant Schraubendreher mit Quergriff hexagon service wrench with T- handle	
	SW 2 x 60	K 119333		SW 4 x 100	K119319
	SW 2,5 x 60	K 119334		SW 5 x 60	K119320
	SW 3 x 60	K 119335			
	Drehmomentschlüssel-Satz Tourque set	K180053			

Schrauben-Anzugsmomente [Nm] Recommended torque [Nm]	Schraube Screw	Schraubendreher Screwdriver	Anzugsmoment Torques setting
	Pos. 5	T 20	6,5 Nm
	Pos. 6	SW 2	max. 2,0 Nm
	Pos. 9	SW 3	max. 4,0 Nm
	Pos. 12	SW 3	max. 4,0 Nm
	Pos. 14	SW 4	10,0 Nm

Einsatzgrenzen 2D/3D Messerkopfsysteme Application limits 2D/3D Milling Cutter				
Durchmesser d [mm] Diameter d [mm]	Zähnezahl z No. of teeth z	Gewicht [kg] Weight [kg]	Max. Schnittgeschwindigkeit v _c [m/min] Max. cutting speed v _c [m/min]	Drehzahl n [1/min.] RPM n [1/min.]
63	3	2,1	2.800	13.500
80	4	2,7	3.100	12.800
100	5/7	2,5	3.500	11.000
125	6/10	3,6	3.900	10.000
160	8/12	6,0	4.000	9.000
200	10/16	10,4	5.000	8.000
250	12/20	16,0	5.600	7.000
315	18/24	28,0	6.000	5.800
400	24	41,0	7.100	5.500

Schneideneinstellung Insert adjustment	Verstellbereich in 2/3 Dimensionen Adjustably in 2/3 dimensions	
	2D	3D
	1 axial (h) ±0,5 mm	1 axial (h) ±0,5 mm
	2 radial (d _r) ±1,0 mm	2 radial (d _r) ±1,0 mm
		3 Planfase ±3° 3 Wiper edge
Einstellgenauigkeit ± 0,002 mm setting accuracy ± 0,002 mm		

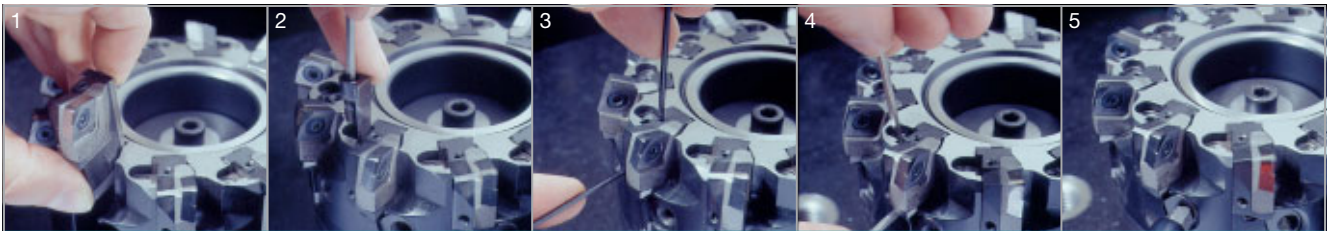

Grundeinstellung der Schneiden:

1. Montieren des Schneidplattenkäfigs (3) auf den Schneidplattenträger (2). Mit den Stellschrauben (6) den Schneidplattenkäfig fixieren. Beim Montieren auf gleiche Ausrichtung der Schneidplattenkäfige achten. Für die Stellschrauben können Torx-Schraubendreher T 8 verwendet werden
2. Danach die Radial-Stellschraube (9) so montieren, dass der Stellkeilsatz plan mit dem Träger abschließt
3. Mit der Stellschraube (12) den Axialstellkeil (11) ganz in den MK-Grundkörper einschrauben. Dabei ist auf die Leichtgängigkeit des Axialstellkeils zu achten. Danach den Axialstellkeil wieder um eine halbe Umdrehung lösen (höherer Teil des Axialstellkeils nach innen)
4. Nun ist der zuvor montierte Käfigträger in den MK-Grundkörper einzubauen. Dabei auf die Planlage zum Axialstellkeil (11) achten (Bild 1)
5. Der Radial-Stellkeil (7) ist mit der Stellschraube (8) ganz nach unten in den MK-Grundkörper zu schrauben, um die Leichtgängigkeit zu überprüfen. Anschließend den Radial-Stellkeil durch Zurückdrehen auf Mittelstellung bringen (Bild 2)
6. Die Radial-Stellschraube (9) soweit anziehen, dass der Stellkeilsatz zum Spannen kommt
7. Den Spannkeil (13) mit der Spannschraube (14) montieren, leicht anziehen und wieder etwas lösen
8. Über Radial-Stellschraube (9) überprüfen, ob der Stellkeilsatz (10) weiterhin am MK-Grundkörper anliegt. Gegebenenfalls korrigieren
9. Zum Schluss der Grundeinstellung wird die Schneidplatte (4) mit der Schraube (5) montiert ($M = 6,5 \text{ Nm}$)

Feineinstellung der Schneiden

Die Feineinstellung sollte über ein optisches Messgerät erfolgen.

1. Die Ausrichtung der Planfase an der Schneidplatte (4) erfolgt durch Verdrehen des Schneidplattenkäfigs (3) über das gleichzeitige Gegeneinanderdrehen der Stellschrauben (6). Beide Stellschrauben müssen nach der Einstellung mit maximal $M = 2 \text{ Nm}$ angezogen sein (Bild 3)
2. Der Rundlauf wird mit der Radial-Stellschraube (8) auf $0,02 \text{ mm}$ vor Nennmaß eingestellt (Bild 4)
3. Der Planlauf (axiale Einstellung) wird mit der Stellschraube (12) auf $0,03 \text{ mm}$ vor dem Nennmaß eingestellt (eventuelles Nachjustieren des Radial-Stellkeils (7) mit der Stellschraube (8), damit dieser unter Vorspannung steht)
4. Der Käfigträger wird nun über den Spannkeil (13) durch Anziehen der Spannschraube (14) gespannt. Das Anzugsdrehmoment M beträgt 10 Nm (Bild 5).
5. Die Feineinstellung des Rundlaufes wird über die Radialstellschraube mit $N = 4 \text{ Nm}$ gemacht
6. Die Feineinstellung des Planlaufes wird über die Axial-Stellschraube (12) mit $M = 4 \text{ Nm}$ realisiert.
7. Bitte achten Sie darauf, dass die Radial-Stellschraube (8) dabei angezogen ist.

Beim Schneidplattenwechsel ohne Demontage des Trägers (2) ist darauf zu achten, dass eine der beiden Stellschrauben gelöst ist.

Basic Insert Setting

1. The insert segment (3) has to be mounted on the seat support (2). Fix the insert segment with the setting screws (6). See to equal alignment of the insert segments during assembly. T8-Torx screwdrivers should be used for tightening the setting screws
2. Insert the only lightly greased wedge-set into seat support. Next to that mount the radial setting screw (9) in a way, that levels up the wedge-set to the seat support
3. Screw in the axial wedge (11) all the way into the cutter body, by turning the setting screw (12). At the same time you have to make sure that the axial wedge is moving smoothly. After that, loosen the axial wedge again by half a turn (higher part of wedge pointing inwards)
4. Now the previously assembled seat support has to be mounted into the cutter body. Watch for the seat support sitting plane to axial wedge (11), (picture 1)
5. In order to check the smooth move, the radial wedge (7) has to be screwed down to the very bottom of the cutter body, this by turning the setting screw. After that center the radial wedge by turning the setting screw backwards. (picture 2)
6. Tighten the radial setting screw (9) until the wedge set comes to grip
7. Mount the clamping piece (13) with the clamping screw (14), tighten slightly
8. Check via radial setting screw, if the wedge-set (10) lays still plane to the cutter body. Re-adjust if necessary
9. In order to finish the basic setting, mount the insert (4) by tightening it with the fixing screw. ($M = 6,5 \text{ Nm}$)

Finetuning of Insert Setting

The fine tuning process should be effected via optical measuring device.

1. The alignment of the wiper edge to the insert edge to insert (4) is being effected by twisting the seat support (3). Therefore the two setting screws have to be counterturned and all wedge parts have to be slightly tightened
2. The radial run-out is being adjusted to $0,02 \text{ mm}$ before the nominal size by turning the radial setting screw (8) (picture 4)
3. The axial run-out is being adjusted to $0,03 \text{ mm}$ before nominal size by turning the axial setting screw (12) (possible re-adjusting of the radial wedge (7) with the setting screw (8), to put it under initial tension).
4. Clamping the seat support by tightening the fixing screw (14) over the clamping wedge (13) (Setting torque $M = 10 \text{ Nm}$, picture 5).
5. Fine tuning of the radial run-out is being done through the radial setting screw (9)
6. Fine tuning of the axial run-out is being achieved by turning the axial setting screw (12).
7. Please make sure that during doing this, the radial setting screw (8) stays tightened

When exchanging the inserts without dismantling the seat support, make sure that one of the two setting screws (6) is untightened.

Für eigene aber auch für fremde Messerkopfsysteme bieten wir Ihnen folgendes Serviceangebot an:

Werkzeugaufbereitung Tooling refurbishment	Reinigung und Einstellung Cleaning and adjustment	Nachschliff von CBN-/PKD-Schneidplatten Regrinding service CBN-/PCD-Inserts
--	---	---

Werkzeugaufbereitung Tooling refurbishment	Bezeichnung Designation
	Werkzeugaufbereitung Messerköpfe d = 50 - 500 mm Tooling refurbishment milling cutter d = 50 - 500 mm
	Gewindebohrung und Gewinde erneuern Thread boring-and thread refurbishment

Reinigung und Einstellung Cleaning and adjustment	Bezeichnung Designation
	1D-HSC-MK Einstellen und Reinigen
	1D-HSC-MC cleaning and adjustment
	2D/3D-HSC-MK Einstellen und Reinigen
	2D/3D-HSC-MC cleaning and adjustment

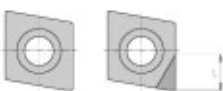
Nachschleifservice Regrinding service	
2D/3D-Schneidplatten / 2D/3D-Inserts	LMT-Code
	SPGW 12 04 ... DP SPGW 12 04 ... BN
	CPGW 12 04 ... DP CPGW 12 04 ... BN

DP- und BN-Wechselplatten sind je nach Verschleiß mehrmals nachschleifbar, Nennmaß des Messerkopfgrundkörpers bleibt erhalten
According to the wear, CBN and PCD inserts can be regrind several times

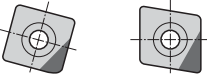
1D-Schneidplatten 1D-Inserts	LMT-Code
	IT ... DP IT ... BN

Auf Wunsch bieten wir einen Nachschleifservice der Wechselplatten an, der einen definierten Nachschliff um 0,2 mm (1. Stufe) bzw. 0,4 mm (2. Stufe) ermöglicht. Die Wechselplatten werden nach dem Nachschliff gekennzeichnet: * = 0,2 mm. ** = 0,4 mm.
Beachten Sie, dass sich der Durchmesser entsprechend dem Nachschliff verringert.

On request we suggest our regrinding service for those inserts, offering a defined regrinding result of 0,2 mm (1. level) resp. 0,4 mm (2. level). After the regrinding process, the inserts are being marked as follow:
* = 0,2 mm, ** = 0,4 mm.
Please consider the diameter reduction in relation to the regrinding process.

Neben den bewährten Standard-Messerkopfsystemen bietet Kieninger, in Abstimmung auf den jeweiligen Bearbeitungsfall, Sonderfrässysteme für die Hochgeschwindigkeitsbearbeitung:

- mit wechselbarer Schneide (Hartmetall, MKD, PKD, CBN), einstellbar/nicht einstellbar
- mit fester Schneide

Next to the reliable standard milling cutter systems, Kieninger also offers special high speed milling solutions according to your application:

- exchangeable cutting edges (carbide, MCD, PCD, CBN), adjustable/non-adjustable
- fixed cutting edges

Großflächige Werkstückbearbeitung Large surface machining

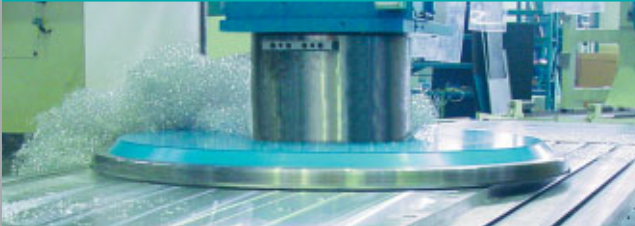

Messerkopfsysteme von Kieninger im Einsatz zur Bearbeitung von Aluminium- und Kunststoffplatten:

Milling Cutter from Kieninger for milling aluminium and plastic slabs

- ruhige Laufeigenschaft
- Schrupp-/Schlichteinstellung
- 2D-einstellbar
- smooth cutting
- semifinishin/finishing set up
- 2D-adjustable

Messerkopf als Sonderlösung, Durchmesser $d = 1600$, 40 Schneiden, zur Oberflächenbearbeitung von Aluminiumplatten

Milling cutter diameter 160 mm, $z = 40$, for face milling of aluminium plates.

Schnittdaten Cutting data:

$n = 430$ 1/min.
 $f_z = 0,08$ mm
 $v_f = 1.376$ mm/min.

Vielzahnfräser Multiple Tooth Cutter



Fräser mit Durchmesser $d = 36$ mm und 5 Schneiden. Einsatz in der Automobilindustrie zur Bearbeitung eines Nockenwellengehäuses.

Milling cutter diameter $d = 36$ mm, $z = 5$, milling of camshaft housing.

- hohe Vorschübe durch maximale Zähnezahl
- hohe Standzeiten durch geringe Schneidenbeanspruchung
- 2D-einstellbar
- Bearbeitung dünnwandiger Werkstücke
- high feed rate due to maximum number of teeth
- extended tool life due to low chip load
- 2D-adjustable
- for machining thin walled parts

Schnittdaten Cutting data:

$n = 12.000$ 1/min.
 $f_z = 0,1$ mm
 $V_f = 6.000$ mm/min.
 $a_p = 0,5$ mm
Oberfläche: $R_z = 4$

Zylinderkopfbearbeitung Cylinder head machining



3D-HSC Messerkopf Milling Cutter P 315-18 R

Werkstück: Zylinderkopf	Component: Cylinder head
Werkstoff: GD-Al (QN 4199 GK)	Material: GD-Al (QN 4199 GK)
Operation: Vorfräsen (Brennraumseite)	Operation: semifinishing (combustion space)

Schnittdaten Cutting data:

$n = 2.500$ U/min
 $v_f = 4.500$ mm/min
 $a_p = 2,5$ mm

Hochglanzfräsen Mirror Finishing



Werkzeuge mit kombinierter Schrupp- und Schlichteinstellung zum Fräsen von Hochglanzoberflächen.

Special milling cutter with a semifinishing/finishing setup for achieving a polished surface of non-ferrous materials.

- Hochglanzbearbeitung von Plexiglas durch Naturdiamant
- Mirror finishing of plexiglas through natural diamond
- modulare einstellbare Frässysteme
- modular adjustable cutter systems

High-Speed-Cutting mit Standard-1D-Messerkopf Ø 125 High Speed Cutting with standard 1D-Milling Cutter Ø 125

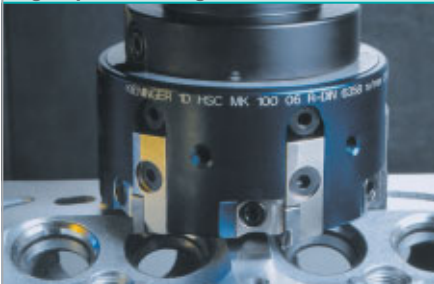

Werkstück: Getriebegehäuse
 Werkstoff: GD-Al Si 9 Cu3
 Operation: Fertigfräsen, Flanschfläche
 Component: Gear housing
 Material: GD-Al Si 9 Cu3
 Application: Finishing of flange surface

Schnittdaten Cutting data:
 $n = 10.000 \text{ U/min}$
 $v_f = 15.000 \text{ mm/min}$
 $a_p = 0,5 \text{ mm}$

3D-Messerkopfsystem 3D-Milling Cutter



Werkstück: Saugrohr
 Werkstoff: GD-Al Si 9 Cu 3
 Operation: Vor-, Fertigfräsen
 Component: Inlet manifold
 Material: GD-Al Si 9 Cu 3
 Application: Semifinishing, finishing

Schnittdaten Cutting data:
 $n = 10.000 \text{ U/min.}$
 $f_z = 0,12 \text{ mm}$
 $a_p = 1,0 \text{ mm}$

PKD-Monoblockfräser PCD Monobloc Cutter



Kompaktes, steifes Werkzeug mit aufgelöteten PKD-Schneiden:

Rigid tool with brazed cutting edges:

- maximale Zähnezahl möglich
- hohe Rund- und Planlaufgenauigkeit
- geeignet für HSC-Bearbeitung, z. B. für dünnwandige Bauteile aus Aluminium oder Magnesium
- nachschleifbar
- maximum number of teeth possible
- lowest runout
- adapted for HSC-machining, e. g. for thin walled aluminium or magnesium parts
- regrindable

Anwendungsbeispiel

Application example

Monoblockfräser, Durchmesser $d = 125 \text{ mm}$, 16 Schneiden für die Bearbeitung von dünnwandigen Aluminium- und Magnesiumteilen.
 Monobloc cutter, diameter $d = 125 \text{ mm}$, $z = 6$, for machining weak aluminium and magnesium components.

PKD Platte Typ 220 PCD tip type 220				CBN Platte Typ 270 CBN tip type 270			
Ø	Dicke Thickness	PCD	ISO-Code	Ø	Dicke Thickness	CBN	ISO-Code
7	2,38	DP012	RDHX 07 02 MO	7	2,38	BN011	RDHX 07 02 MO
8	2,38	DP012	RDHW 08 02 MO	8	2,38	BN011	RDHW 08 02 MO
10	3,18	DP012	RDHW 10 03 MO	10	3,18	BN011	RDHW 10 03 MO
12	3,97	DP012	RDHX 12T3 MO	12	3,97	BN011	RDHX 12 T3 MO

Präzisionswerkzeug in Hartmetall, in polycrystallinem Diamant und in Bornitrid
Precision tooling in carbide, polycrystalline diamond and polycrystalline borium materials

Werkzeughalter mit zylindrischem Schaft Typ 290 Circular tool holder with cylindrical shank Type 290

Rechtsschneidend	Clockwise cutting					
Stahlkörper	Steel body					
Toleranz D1 = ± 0,05	Tolerance on D1 = ± 0,05					
Wuchtgüte G 2,5 für 10.000 U/min	Balanced tool holder G 2.5 at 10,000 tr/mn					
d ₁	d ₂	d ₃	l ₂	l ₁	z	Ident No.
20	20	8	110	60	2	290 200
25	25	10	125	69	2	290 250
32	32	12	130	70	2	290 320

Präzisionswerkzeug in Hartmetall, in polycrystallinem Diamant und in Bornitrid
Precision tooling in carbide, polycrystalline diamond and polycrystalline borium materials



Plan- und Eckfräsköpfe

Face Milling Cutters

Auswahlübersicht Selection table	122
Twincut-Plan-, Kopier- und Eckfräsköpfe 45° und 90° Twincut Face and Copying Milling Cutters 45° and 90°	124
Eckfräsköpfe 90° mit Twincut-Geometrie Face Milling Cutters 90° with Twincut geometry	128
Univex-Eckfräsköpfe 90° Univex Face Milling Cutters 90°	130
Eckfräsköpfe 90° für ISO-Wendeplatten Face Milling Cutters 90° for ISO Indexable Inserts	132
Twincut-VA Planfräsköpfe 45° Twincut VA Face Milling Cutters 45°	134
Planfräsköpfe 45° für ISO-Wendeplatten Face Milling Cutters 45° for ISO Indexable Inserts	136
Schnittwertempfehlungen Cutting data recommendations	140, 142

Auswahlübersicht Selection table

Plan-, Kopier- und Eckfräsköpfe Face and Copying Milling Cutters

	Cat.-No.			α	a_p	Nenn-Ø Nominal-Ø	Seite Page
	FCT XX Vario	Plan- und Kopierfräsköpfe Twincut Face Milling and Copying Cutters Twincut	OCKX 0606 RCKX 1606	45°	4	36 – 125	124
	FCT45	Plan- und Kopierfräsköpfe Twincut Face Milling and Copying Cutters Twincut	OCKX 0606 RCKX 1606	45°	4	52 – 125	124
	FMT45 11250-09	Planfräsköpfe Twincut 45° Face Milling Cutters Twincut 45°	SNKX 0904	45°	5	32 – 63	126
	FMT45 11250-12		SNKX 1205	45°	7	80 – 160 40 – 160	
	FMT45 11250-12 EF		SNKQ 1205 AN	45°	5,5	80 – 315	
	FMH45 11172	Planfräsköpfe 45° Face Milling Cutters 45°	SEKN 1203	45°	5,5	40 – 100	136
	FMH45A 11173		SEKN 1204	45°	5,5	40 – 100	124
	FMH45B 11171		SEHW 1204	45°	5,5	40 – 100	138

Auswahlübersicht Selection table

Plan-, Kopier- und Eckfräsköpfe Face and Copying Milling Cutters

	Cat.-No.			κ	a_p	Nenn-Ø Nominal-Ø	Seite Page
	FMV45 11280	Planfräsköpfe Face Milling Cutters Twincut VA 45°	SNHX1205 	45°	5	50 – 160	134
	FMT90 11260-09	Eckfräsköpfe 90° mit Twincut-Geometrie Face Milling Cutters 90° with Twincut geometry	SPKX 0904 	90°	8	40 – 63	128
	FMT90 11260-12		SPKX 1205 	90°	10	50 – 160	
	FMU90 11475-IK	Eckfräsköpfe Face Milling Cutters Univex 90°	ADHX 12T3 	90°	12	40 – 80	130
	FMH90 11415	Eckfräsköpfe 90° Face Milling Cutters 90°	APKT 1003 	90°	8	40 – 80	132
			APKT 1604 	90°	14	40 – 100	

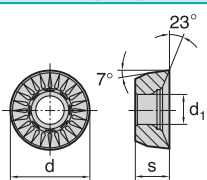
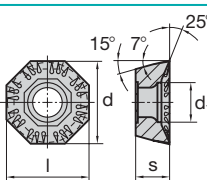
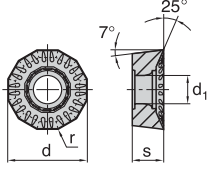
N = Anzahl der Schneidkanten N = Number of cutting edges						ISO-Code Cat-No.	Schneidstoffsorten Cutting materials Ident No.											Für Fräser For cutter Cat-No.						
	l	s	d	d ₁	b/r		LC240T	LC240S	LC230F	LC225T	LC225S	LC630T	LW240	LW225	LC440T	LC444W	LC610E		LC610T	LC610W	LC610A	LW610	LC603Z	
 N = 2	6,35	16	5,8			RCKX 1606 MO-TR	1068433				1068431	1068432	1068430				1068435			1068434			FCT45 FCTXX MCT45	
	6,35	16	5,8			RCKX 1606 MO-TRT breite Schneidkantenfase wide land	1055730 ¹⁾				1068460						1068464							
 N = 8	16	6,35	16	5,8	0,5	OCKX 0606 AD-TR	1054003		1068004		1054001	1054002	1054000											FCT45 FCTXX MCT45
	16	6,35	16	5,8	0,5	OCKX 0606 AD-TRT breite Schneidkantenfase wide land	1055731 ¹⁾				1054012						1055011							
 N = 2	6,35	16	5,8			XCKX1606ZDR-TR	1055677		1068010		1055676	1055674	1055673				1055678							FCT45 MCT45

¹⁾ LC280TT Schruppgeometrie mit 2-fach Beschichtung
Roughing geometry with double coating

Sortenbeschreibung/-bezeichnung und ISO-Code ab Seite 22
Description/Designation of grades and ISO-Code starting page 22

FCT 45 							OCKX0606 XCKX1606 RCKX1606 				
d ₁	d ₄	h	d ₂	z	Ident No.	LMT-Code	Wendeplatte Insert			Ident No.	Ident No.
52	16	40	22	4	1041011	FCT45 O06.052AN	RCKX1606	OCKX0606	XCKX1606	1045777	1048344
66	16	50	27	5	1041012	FCT45 O06.066AN					
80	16	50	27	6	1041013	FCT45 O06.080AN					
100	16	50	32	7	1041014	FCT45 O06.100AN					
125	16	63	40	8	1041015	FCT45 O06.125AN					

FCT XX Twincut-Vario 							RCKX1606 OCKX0606 					
d ₁	d ₃	d ₄	h	d ₂	z	Ident No.	LMT-Code	Wendeplatte Insert			Ident No.	Ident No.
36	54,6	16	40	22	4	1041016	FCTXX R16.036AN	RCKX1606	OCKX0606	1045777	1048344	
50	68,6	16	50	27	6	1041017	FCTXX R16.050AN					
63	81,6	16	50	27	6	1041018	FCTXX R16.063AN					
63	81,6	16	50	27	8	1041019	FCTXX R16.063AN-F					
80	98,6	16	50	32	8	1041020	FCTXX R16.080AN					
100	118,6	16	50	40	10	1041022	FCTXX R16.100AN					
125	143,6	16	63	40	10	1041024	FCTXX R16.125AN					

Weitere Informationen siehe Fette-Druckschrift Nr. 1834
 Further informations see Fette-brochure No. 1834

¹⁾ Winkel am Werkstück 43°
¹⁾ Angle on workpiece 43°

Schnittwertempfehlungen ab Seite 142
 Cutting data recommendations starting page 142

Besondere Merkmale:

- Doppelt negative Plattenlage mit hochpositiven Spanwinkeln
- Weiches und geräuscharmes Fräsen
- Große Plattendicke und stabiler Querschnitt
- Großflächige Rückenanlage der Wendepplatten
- Zum Tauchfräsen und Auskoffern

Special features:

- Double negative insert position with high positive rake angles
- Smooth and low noise milling
- Inserts with large thickness, rigid cross section
- Large surface contact area of the insert
- For plunge and heavy die sinking operations

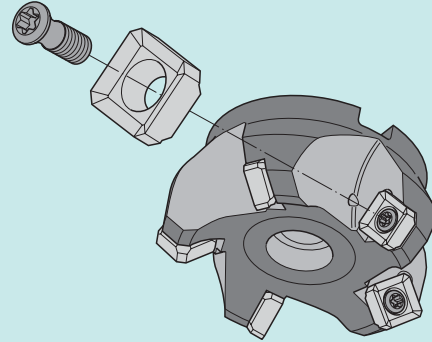

N = Anzahl der Schneidkanten N = Number of cutting edges						ISO-Code Cat-No.	Schneidstoffsorten Cutting materials Ident No.											Für Fräser For cutter Cat-No.					
	l	s	d	d ₁	b/r		LC240T	LC240S	LC230F	LC225T	LC225S	LC630T	LW240	LW225	LC440T	LC444W	LC610E		LC610T	LC610W	LC610A	LW610	LC603Z
 N = 4	9,52	4,76		4,4	1,5	SNKX 0904 AN 1187-00	1052316	1052294	1068006														FMT45 EBT X ERT90
	12,7	5,56		5,2	2	SNKX 1205 AN 1187-10	1052301	1052230	1068007	1052315	1052228					1052234	1052339				1052236	MMT45 MMT87 FMT45	
	9,52	4,76		4,4	1,5	SNKX 0904 AN-TT	1055743 ¹⁾															1052236	FMT87 EBT X ERT90 FRT90
 N = 4	12,7	5,56		5,2	2	SNKX 1205 AN-TR 1187-10 TR	1052248	1052245		1052239	1052237											1052249	MMT45 MMT87 FMT45
	12,7	5,56		5,2	2	SNKX 1205 AN-TT breite Schneidkantenfase wide land	1055742 ¹⁾																FMT87 EBT X ERT90 FRT90
 N = 4	12,7	5,44		5,2	2	SNKX 1205 AN-T 1187-12 breite Schneidkantenfase wide land	1052303	1052258	1068008	1052314	1052256							1052309			1052254	MMT45 MMT87 FMT45 FMT87 EBT X ERT90 FRT90	
 N = 8	12,7	5,56		5,2	2	SNKQ 1205 AN 1187-13		1052310														1052305	MMT45 MMT87 FMT45 FMT87 ERT90
 N = 1	19,05	5,56	12,7	5,2		1187-90 Breitschichtplatte Wiper s = ± 0,01 d = ± 0,015					2305343											2304503	MMT45 FMT45

¹⁾ LC280TT Schruppgeometrie mit 2-fach Beschichtung
Roughing geometry with double coating

Sortenbeschreibung/-bezeichnung und ISO-Code ab Seite 22
Description/Designation of grades and ISO-Code starting page 22

FMT45 11250							11250		11250-IK		LMT-Code		Ident No.		Ident No.	
d ₁	a _p	d ₃	h	d ₂	z	Ident No.	Ident No.	LMT-Code		Ident No.		Ident No.				
11250-09																
32	5	42	40	16	4	1027292		FMT45 S09.032AN	SNKX 0904 AN	1045114	1048335					
40	5	50	40	22	5	1027294		FMT45 S09.040AN	1187-00		T15					
50	5	60	40	22	6	1027296		FMT45 S09.050AN								
63	5	73	40	22	7	1027298		FMT45 S09.063AN								
11250-12																
40	7	54	40	22	3		1027300	FMT45 S12.040AN-I	SNKX 1205 AN	1045123	1048344					
50	7	64	40	22	4		1027302	FMT45 S12.050AN-I	1187-10		T20					
63	7	77	40	22	5		1027304	FMT45 S12.063AN-I								
80	7	94	50	27	6	1027314	1027306	FMT45 S12.080AN(-I)								
100	7	114	50	32	7	1027316	1027308	FMT45 S12.100AN(-I)								
125	7	139	63	40	8	1027318	1027310	FMT45 S12.125AN(-I)								
160	7	174	63	40	9	1027320	1027312	FMT45 S12.160AN(-I)								
80	7	94	50	27	6	1027314		FMT45 S12.080AN								
100	7	114	50	32	7	1027316		FMT45 S12.100AN								
125	7	139	63	40	8	1027318		FMT45 S12.125AN								
160	7	174	63	40	9	1027320		FMT45 S12.160AN								

FMT45 11250-12 EF							11250-12 EF		LMT-Code		Ident No.		Ident No.	
d ₁	d ₃	a _p	h	d ₂	z	Ident No.	Ident No.	LMT-Code		Ident No.		Ident No.		
80	94	7	50	27	10	1027361		FMT45 S12.080AN-E	SNKQ 1205 AN	1045123	1048344			
100	114	7	50	32	12	1027362		FMT45 S12.100AN-E	1187-13					
125	139	7	63	40	16	1027363		FMT45 S12.125AN-E						
160	174	7	63	40	20	1027364		FMT45 S12.160AN-E						
200	214	7	63	60	24	1027365		FMT45 S12.200AN-E						
250	264	7	63	60	30	1027366		FMT45 S12.250AN-E						
315	329	7	80	60	36	1027367		FMT45 S12.315AN-E						

¹⁾ Winkel am Werkstück 43,5°
¹⁾ Angle on workpiece 43,5°

Schnittwertempfehlungen ab Seite 140
 Cutting data recommendations starting page 140

Besondere Merkmale:

- Große Plattendicke und stabiler Querschnitt
- Weiches und geräuscharmes Fräsen durch hochpositiven Spanwinkel
- Wendeplatte mit 4 Schneiden

Special features:

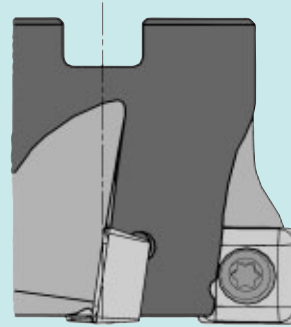

- Large insert thickness size and rigid cross section
- Smooth and low noise milling with high positive rake angles
- indexable insert with 4 cutting edges



- Exaktes 90°-Eckfräsen
- Accurate 90° Angle milling

N = Anzahl der Schneidkanten N = Number of cutting edges						ISO-Code Cat-No.	Schneidstoffsorten Cutting materials Ident No.											Für Fräser For cutter Cat-No.					
	l	s	d	d ₁	b/r		LC240T	LC240S	LC230F	LC225T	LC225S	LC630T	LW240	LW225	LC440T	LC444W	LC610E		LC610T	LC610W	LC610A	LW610	LC603Z
 N = 4	9,52	4,76		4,4	0,6	SPKX 090406 1187-05	1055658				1069538		1055657 1069537				1069548				1069547		FMT90
	12,7	5,56		5,2	0,8	SPKX 120508 1187-15	1052247 1052246			1052244			1052240				1052659				1052242		11260-12 FMT90 MMT90

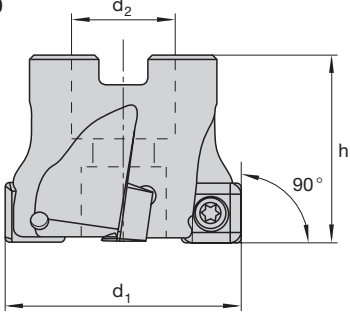
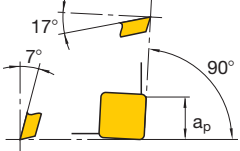
Sortenbeschreibung/-bezeichnung und ISO-Code ab Seite 22
Description/Designation of grades and ISO-Code starting page 22

FMT90 11260													
d ₁	a _p	h	d ₂	z	Ident No.	LMT-Code		Ident No.	Ident No.				
11260-09													
40	7	40	16	5	1027394	FMT90 S09.040AN	SPKX 090406 1187-05	1045114	1048335				
50	7	40	22	6	1027395	FMT90 S09.050AN							
63	6	40	22	7	1027396	FMT90 S09.063AN							
11260-12													
50	10	40	22	4	1027380	FMT90 S12.050AN	SPKX 120508 1187-15	1045123	1048344				
63	10	40	22	5	1027382	FMT90 S12.063AN							
80	10	50	27	6	1027384	FMT90 S12.080AN							
100	10	50	32	7	1027386	FMT90 S12.100AN							
125	10	63	40	8	1027388	FMT90 S12.125AN							
160	10	63	40	9	1027390	FMT90 S12.160AN							

Werkzeuge mit innerer Kühlmittelzufuhr auf Anfrage
 Tools with internal coolant supply upon request

Schnittwertempfehlungen ab Seite 140
 Cutting data recommendations starting page 140

- 1 Rhombische Form für große Schnitttiefen.
1 Rhombic shape for large depths of cut.
- 2 Konvexe Planfase an den Schneidenecken für hohe Oberflächengüte.
2 Convex flat land on the cutting edge corners gives high surface finish.
- 3 Exaktes 90°-Eckfräsen, auch bei positiver Anstellung der Wendeplatte. Konvexer Anschliff der Schneide erzeugt exakt gerade Wandungen der gefrästen Nut, trotz des hohen positiven Axialwinkels.
3 Accurate 90° angle milling, even with positive setting of the indexable insert. Convex grinding angle of the cutting edge produces accurate straight walls of the milled slot, despite of the high positive axial rake angle.
- 4 Allseitig präzisionsgeschliffen, dadurch hohe Rund- und Planlaufgenauigkeit.
4 Precision ground on all sides, gives excellent true running on o. d. and face.

- 5 Spezieller schräger Hohlkehlenanschliff für konstanten positiven Spanwinkel über die gesamte Schneidkante.
5 Special chip groove grinding gives constant positive rake over the entire cutting edge length.
- 6 Sicherer und genauer Plattensitz (präzisionsgefräst) mit Dreipunktanlage.
6 Secure and accurate index seating (precision-milled) with three point contact.

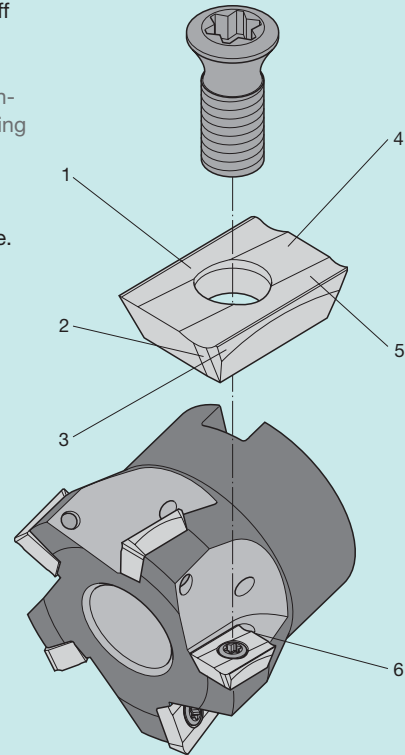





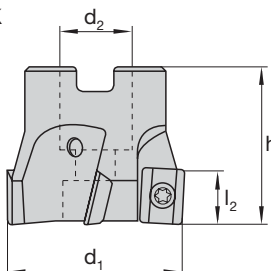
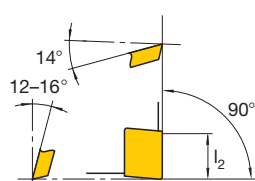

N = Anzahl der Schneidkanten N = Number of cutting edges							Schneidstoffsorten Cutting materials Ident No.											Für Fräser For cutter Cat-No.							
	l	s	d	d ₁	b/r	ISO-Code Cat-No.	LC240T	LC240S	LC230F	LC225T	LC225S	LC630T	LW240	LW225	LC440T	LC444W	LC610E		LC610T	LC610W	LC610A	LW610	LC603Z		
<p>N = 2</p>	12,7	3,97	9,52	4	0,6	ADHX 12T306 ER 1196-84	1069403	1069463	1068003		1069449		1069461	1069447	1067542			1069492				1069448	1069489	ERU90 FMU90 FRU90	
	12,7	3,97	9,52	4	1,5	ADHX 12T315 ER 1196-84 R06					1960092			1960091											
	12,7	3,97	9,52	4	2,3	ADHX 12T323 ER 1196-84 R09					1960095			1960094											
	12,7	3,97	9,52	4	0,6	ADMX 12T306 ER 1196-85	1069526	1069386			1069468		1069385	1069462					1069530				1069466		
	12,7	3,97	9,52	4	0,6	ADHX 12T306SR-BM									1067535										ERU90 FMU90 FRU90

¹⁾ Andere Eckenradien auf Anfrage
¹⁾ Other corner radii on request

Sortenbeschreibung/-bezeichnung und ISO-Code ab Seite 22
Description/Designation of grades and ISO-Code starting page 22

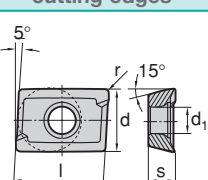
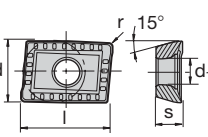

<p>FMU90 11475-IK</p> 										
<p>IK = Innere Kühlmittelzufuhr IK = Internal coolant supply</p>										
d ₁	l ₂	h	d ₂	z 	Ident No.	LMT-Code	Ident No.		Ident No.	
40	12	36	16	4	1039804	FMU90 A12.040AN-I	ADHX 12T306 1196-84	1045114	1048335	
50	12	40	22	5	1039806	FMU90 A12.050AN-I				
63	12	40	22	6	1039808	FMU90 A12.063AN-I				
80	12	50	27	7	1039810	FMU90 A12.080AN-I				

N = Anzahl der Schneidkanten N = Number of cutting edges							ISO-Code Cat-No.	Schneidstoffsorten Cutting materials Ident No.												Für Fräser For cutter Cat-No.					
	l	s	d	d ₁	b/r	LC240T		LC240S	LC230F	LC225T	LC225S	LC630T	LW240	LW225	LC440T	LC444W	LC610E	LC610T	LC610W		LC610A	LW610	LC603Z		
 <p>N = 2</p>	12,7	3,97	9,52	4	0,6	ADHX 12T306 FR-ALC 1196-84 ALC											1069536						1069535	ERU90 FMU90 FRU90	
	12,7	3,97	9,52	4	0,6	ADKX 12T3PE 1196-89	1055016		1058015		1055014						1055015	1055013						1055018	ERU90 FMU90 FRU90

Schnittwertempfehlungen ab Seite 140
 Cutting data recommendations starting page 140

Besondere Merkmale:

- Universell einsetzbar
- Zum Nuten- und Kantenfräsen
- Für ein breites Spektrum von Werkstoffen
- Stabile Wendepplatte
- Große Schneidenlänge
- Positive Schneidengeometrie
- Hohe Schneidkantenstabilität

Special features:

- Universal application
- To mill slots and edges
- For a wide range of materials
- Stable indexable inserts
- Large cutting length
- Positive cutting geometry
- High cutting edge stability

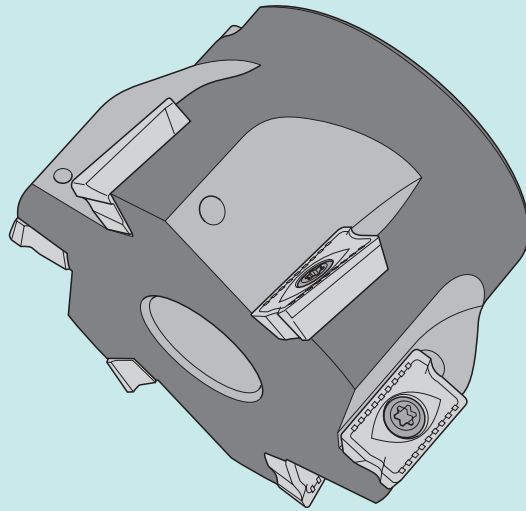

N = Anzahl der Schneidkanten N = Number of cutting edges						ISO-Code	Schneidstoffsorten Cutting materials										Für Fräser For cutter Cat-No.				
	l	s	d	d ₁	b/r		LC240T	LC230F	LC225T	LC225S	LW225	LC440T	LC444W	LC610E	LC610T	LC610T		LC610A	LW610		
 N = 2	10,96	3,5	6,6	2,8	0,5	APHT 1003PDFR-ALC													●	●	FMH90 A10
	17,3	5,26	9,52	4,5	0,8	APHT 1604PDFR-ALC													●	●	FMH90 A16
 N = 2	10,96	3,5	6,6	2,8	0,5	APKT 1003PDSR-BM						●									FMH90 A10
	17,3	5,26	9,52	4,5	0,8	APKT 1604PDSR-BM						●									FMH90 A16
 N = 2	10,96	3,5	6,6	2,8	0,5	APKT 1003PDSR-BP	●	●	●	●	●										FMH90 A10
	17,3	5,26	9,52	4,5	0,8	APKT 1604PDSR-BP	●	●	●	●	●										FMH90 A16
	17,3	5,26	9,52	4,5	1,6	APKT 160416SR-BP		●	●		●			●							
	17,3	5,26	9,52	4,5	2,4	APKT 160424SR-BP		●	●		●										
	17,3	5,26	9,52	4,5	3,2	APKT 160432SR-BP		●	●		●										

Sortenbeschreibung/-bezeichnung und ISO-Code ab Seite 22
Description/Designation of grades and ISO-Code starting page 22

FMH90 11415										
d ₁	l ₂	h	d ₂	z	Ident No.	LMT-Code		Ident No.	Ident No.	
40	8	40	22	6	1028515	FMH90 A10.040AN	APKT 1003 PDR	1044972	1048326	
50	8	40	22	7	1028516	FMH90 A10.050AN				
63	8	40	22	9	1028517	FMH90 A10.063AN				
80	8	50	27	11	1028518	FMH90 A10.080AN	APKT 1604 PDR	1045131	1048335	
40	14	36	16	4	1028510	FMH90 A16.040AN				
50	14	40	22	5	1028511	FMH90 A16.050AN				
63	14	40	22	6	1028512	FMH90 A16.063AN				
80	14	50	27	7	1028513	FMH90 A16.080AN				
100	14	50	32	8	1028514	FMH90 A16.100AN				

Schnittwertempfehlungen ab Seite 140
 Cutting data recommendations starting page 140

Besondere Merkmale:

- Für die Bearbeitung von nichtrostenden Stählen und anderen langspanenden Werkstoffen
- Zum Planfräsen, Anfasen, Schruppen und Schlichten
- Besonders weicher Schnitt und geringe Geräusentwicklung
- Sichere Spanabfuhr durch Wendelspäne

Special features:

- Designed for the machining of tempered and die steels as well as for non-ferrous metals and cast metals
- Designed for face milling, chamfering, roughing and finishing operations
- Extremely smooth cutting action with low noise level
- Secure chip flow by shear chip curl action

1 Große positive Spanwinkel, tiefe Spanmulde
1 Large positive rake angles deep chip groove

2 Prismatischer Grundkörper, großflächige, stabile Plattenauflage
2 Prism shaped basic body large rear surface contact area

3 Große Plattendicke, stabiler Querschnitt
3 Large insert thickness, rigid cross section

4 Umfangsgeschliffen scharfkantige Schneide, gute Planlaufgenauigkeit, hohe Oberflächen-
güten
4 Ground all-over on the circumference sharp cutting edge true running on end face excellent surface qualities

Plattensitz

Insert position



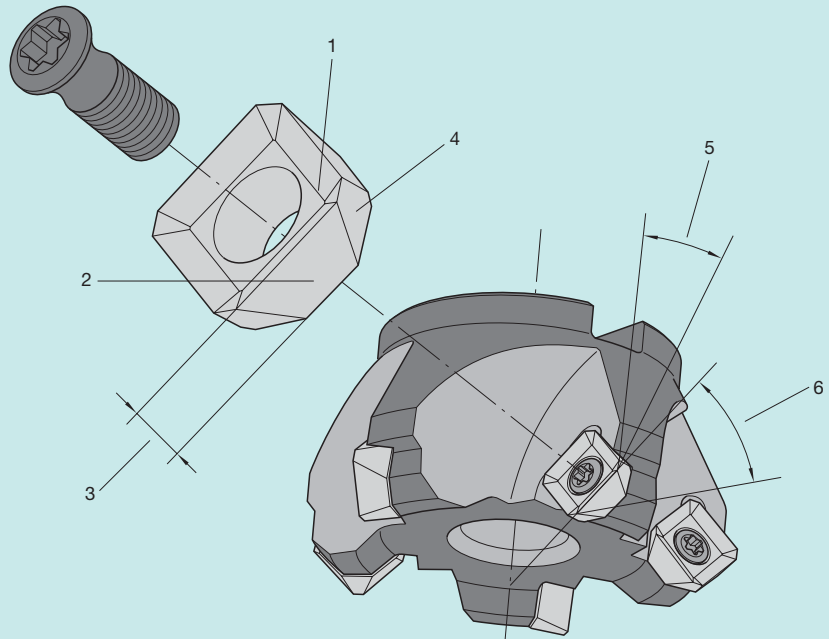

5 Axial 10° positiv
5 Axially 10° positive

6 Radial 30° negativ
6 Radially 30° negative

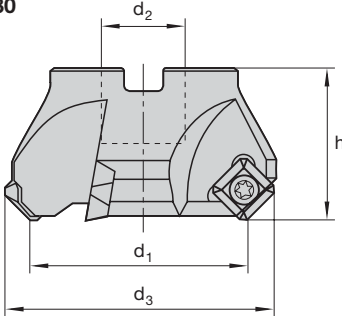
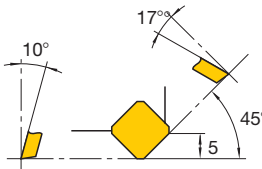

N = Anzahl der Schneidkanten N = Number of cutting edges							ISO-Code Cat-No.	Schneidstoffsorten Cutting materials Ident No.											Für Fräser For cutter Cat-No.					
	l	s	d	d ₁	b/r	LC240T		LC240S	LC230F	LC225T	LC225S	LC630T	LW240	LW225	LC440T	LC444W	LC610E	LC610T		LC610W	LC610A	LW610	LC603Z	
<p>N = 4</p>	12,7	5,56		5,2	2	SNHX 1205 AE 1187-18			1068005	1052306			1052300	1067543										FMV45
		12,7	5,56		5,2	2	SNHX 1205 AESN-BM								1067537									

Sortenbeschreibung/-bezeichnung und ISO-Code ab Seite 22
Description/Designation of grades and ISO-Code starting page 22

<p>FMV45 11280</p>    									
d ₁	d ₃	h	d ₂	z 	Ident No.	LMT-Code		Ident No.	Ident No.
50	61	40	22	4	1027331	FMV45 S12.050AN	SNHX 1205 AE 1187-18	1045123	1048344
63	74	40	22	5	1027330	FMV45 S12.063AN			
80	91	50	27	6	1027332	FMV45 S12.080AN			
100	111	50	32	7	1027334	FMV45 S12.100AN			
125	136	63	40	8	1027336	FMV45 S12.125AN			

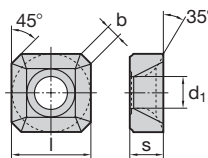
N = Anzahl der Schneidkanten N = Number of cutting edges							Schneidstoffsorten Cutting materials Ident No.											Für Fräser For cutter Cat-No.						
	l	s	d	d ₁	b/r	ISO-Code Cat-No.	LC240T	LC240S	LC230F	LC225T	LC225S	LC630T	LW240	LW225	LC440T	LC444W	LC610E		LC610T	LC610W	LC610A	LW610	LC603Z	
 <p>N = 4</p>	12,7	5,56		5,2	2	SNHX 1205 AE-ALC 1187-18 ALC												1052255			1068030	1052235		FMV45

Schnittwertempfehlungen ab Seite 140
Cutting data recommendations starting page 140

Besondere Merkmale:

- Hochpositive Schneidengeometrie
- Weiches Anschneiden
- Hohe Schnittleistung auch bei antriebschwachen Maschinen oder labilen Verhältnissen
- Sichere Spannung der Wendeplatten durch Tellerschraube (Linksgewinde)
- ISO-Wendeplatten

Special features:

- High positive cutting geometry
- Soft cutting action
- High cutting capacity also with low-power machines or unstable conditions
- Screw (left-hand thread) clamping to firmly secure the throw away inserts
- ISO indexable inserts

Cat.-No. FMH 45 11172

für SEKN(R) 1203 .. Wendeplatten mit HM-Auflageplatte zum Schutz des Trägerkörpers.
for SEKN(R) 1203 .. indexable inserts with carbide shim plate to protect the carrier body.

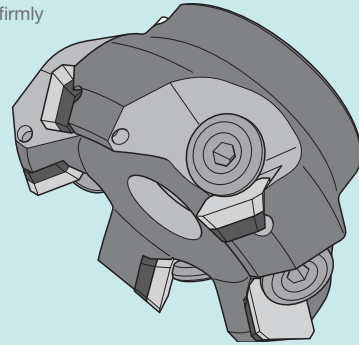





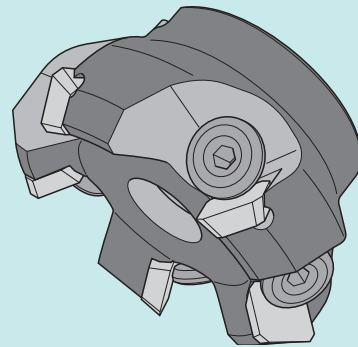

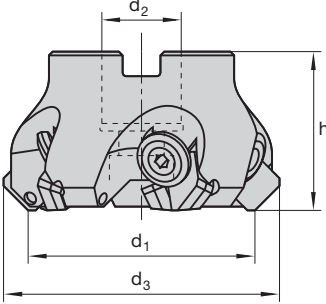
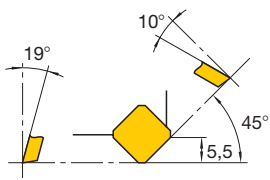

Cat.-No. FMH45A 11173

für SEKN(R) 1204 .. Wendeplatten.
Die große Plattendicke ermöglicht hohe Vorschübe bei hoher Produktionssicherheit.
for SEKN(R) 1204 .. indexable inserts.
The large insert thickness permits high feed rates at maximum production safety.

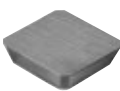





N = Anzahl der Schneidkanten N = Number of cutting edges						ISO-Code	Schneidstoffsorten Cutting materials										Für Fräser For cutter Cat-No.		
	l	s	d	d ₁	b/r		LC240T	LC230F	LC225T	LC225S	LW225	LC440T	LC444W	LC610E	LC610T	LC610T		LC610A	LW610
 N = 4	12,7	3,18	12,7		1,4	SEKN 1203AFEN	●				●								FMH45
	12,7	3,18	12,7		1,4	SEAN 1203AFSN				●	●								
	12,7	3,18	12,7		1,4	SEKN 1203AFSN	●	●	●	●	●			●	●				FMH45A
	12,7	4,76	12,7		1,4	SEKN 1204AFEN						●							
	12,7	4,76	12,7		1,4	SEKN 1204AFSN	●	●	●	●	●			●	●				
 N = 4	12,7	3,18	12,7		1,4	SEKR 1203AFSN	●	●	●	●	●								FMH45
	12,7	4,76	12,7		1,4	SEKR 1204AFSN	●	●	●	●	●								FMH45A
 N = 4	12,7	3,18	12,7		1,4	SEKR 1203AFSN-BM						●							FMH45
	12,7	4,76	12,7		1,4	SEKR 1204AFSN-BM						●							FMH45A

Sortenbeschreibung/-bezeichnung und ISO-Code ab Seite 22
Description/Designation of grades and ISO-Code starting page 22

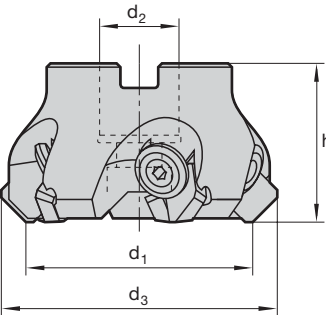
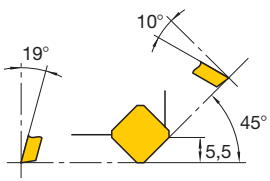
<p>FMH45 11172</p>   						     						
d ₁	d ₃	h	d ₂	z	Ident No.	LMT-Code	Ident No.	Ident No.	Ident No.	Ident No.	Ident No.	
40	53	45	16	3	1027010	FMH45 S12.040AN	SEKN 1203 AF	1050904	1048317	1050902	1050903	2146539
50	63	48	22	4	1027011	FMH45 S12.050AN						
63	76	40	22	5	1027012	FMH45 S12.063AN						
80	93	50	27	6	1027013	FMH45 S12.080AN						
100	113	50	32	6	1027014	FMH45 S12.100AN						

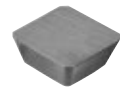
Planfräsköpfe 45°, hochpositiv
Face Milling Cutters 45°, high positive

<p>FMH45A 11173</p>   						  			
d ₁	d ₃	h	d ₂	z	Ident No.	LMT-Code	Ident No.	Ident No.	
40	53	45	16	3	1027020	FMH45A S12.040AN	SEKN 1204 AF	1050904	1048317
50	63	48	22	4	1027021	FMH45A S12.050AN			
63	76	40	22	5	1027022	FMH45A S12.063AN			
80	93	50	27	6	1027023	FMH45A S12.080AN			
100	113	50	32	6	1027024	FMH45A S12.100AN			

Schnittwertempfehlungen ab Seite 140
 Cutting data recommendations starting page 140

Besondere Merkmale:

- Hochpositive Schneidengeometrie
- Weiches Anschneiden
- Hohe Schnittleistung auch bei antriebschwachen Maschinen oder labilen Verhältnissen
- ISO-Wendeplatten mit Lochklemmung

Special features:

- High positive cutting geometry
- Soft cutting action
- High cutting capacity also with low-power machines or unstable conditions
- ISO indexable inserts with hole clamping

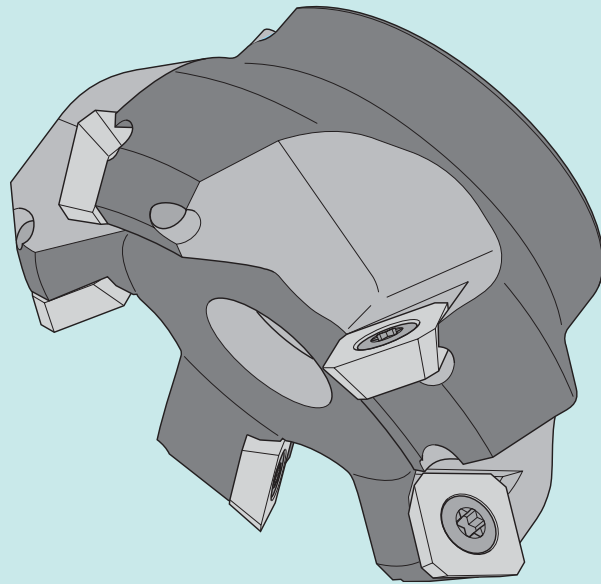

N = Anzahl der Schneidkanten N = Number of cutting edges						ISO-Code	Schneidstoffsorten Cutting materials								Für Fräser For cutter Cat-No.				
	l	s	d	d ₁	b/r		LC240T	LC230F	LC225T	LC225S	LW225	LC440T	LC444W	LC610E		LC610T	LC610T	LC610A	LW610
 N = 4	12,7	4,76	12,7	5,5		SEHT 1204AFEN					●								FMH45B
	12,7	4,76	12,7	5,5		SEKT 1204AFSN	●	●		●	●								
 N = 4	12,7	4,76	12,7	5,5		SEKW 1204AFEN						●	●						FMH45B
	12,7	4,76	12,7	5,5		SEKW 1204AFSN	●	●	●	●	●			●					
 N = 4	12,7	4,76	12,7	5,5		SEHT 1204AFFN-ALC									●	●	●		FMH45B
 N = 4	12,7	4,76	12,7	5,5		SEHT 1204AFSN-BM					●								FMH45B

Sortenbeschreibung/-bezeichnung und ISO-Code ab Seite 22
 Description/Designation of grades and ISO-Code starting page 22

<p>FMH45B 11171</p>									
d ₁	d ₃	h	d ₂	z	Ident No.	LMT-Code		Ident No.	Ident No.
40	53	45	16	3	1027000	FMH45BS12.040AN	SEHW 1204 AF	1045777	1048344
50	63	48	22	4	1027001	FMH45BS12.050AN			
63	76	40	22	5	1027002	FMH45BS12.063AN			
80	93	50	27	6	1027003	FMH45BS12.080AN			
100	113	50	32	6	1027004	FMH45BS12.100AN			

Schnittwertempfehlungen ab Seite 140
 Cutting data recommendations starting page 140

Werkstoff	Material	R _m /UTS (N/mm ²)	empfohlene HM-Sorte recommended Carbide Grade	Vorschub pro Zahn mm Feed per tooth mm			Leistungsfaktor Efficiency factor LF cm ³ /min · kW
				Schichten Finishing	Schruppen Roughing		
					0,1	0,3	
				Schnittgeschwindigkeit Cutting speed v _c m/min			
Unlegierter Baustahl	Plain carbon steel	- 700	LC225S	220	180	140	24
Automatenstahl	Free cutting steel	- 700	LC225S	220	180	140	22
Baustahl	Structural alloy steel	500 – 950	LC225S	180	150	120	20
Vergütungsstahl, mittelfest	Heat-treatable steel, medium strength	500 – 950	LC225S	160	130	100	18
Stahlguss	Cast steel	- 950	LC225S	160	130	100	18
Einsatzstahl	Case hardening steel	- 950	LC225S	160	130	100	18
Rost- und säurebeständiger Stahl, ferritisch, martensitisch	Stainless steel, ferritic, martensitic	500 – 950	LC225S	170	140	-	16
Vergütungsstahl, hochfest	Heat-treatable steel, high strength	950 – 1400	LC240T	150	120	-	16
Nitrierstahl, vergütet	Nitriding steel	950 – 1400	LC240T	150	120	-	16
Werkzeugstahl	Tool steel	950 – 1400	LC240T	150	120	-	14
Rost- und säurebeständiger Stahl, austenitisch	Stainless steel, austenitic	500 – 950	LC440T	250 – 350 90 ³⁾	250 – 350 90 ³⁾	-	18
Martensitaushärtbarer Stahl	Maraging steel						
Grauguss	Grey cast iron	100 – 400 (120–260 HB)	LC225S ²⁾	210	160	130	30
Legierter Grauguss	Alloyed grey cast iron	150 – 250 (160–230 HB)	LC225S ²⁾	160	130	100	22
Sphäroguss	Nodular cast iron	400 – 800 (120–310 HB)	LC225S ²⁾	160	130	100	24
Temperguss	Malleable cast iron	350 – 700 (150–280 HB)	LC225S ²⁾	210	160	120	24
Rein-Metalle, weich	Pure metals, soft	- 500	LC225S	500	350	250	50
Aluminium-Legierungen, langspanend	Aluminium alloys, long chipping	- 550	LW610 ¹⁾	1200	900	700	60
Aluminium-Legierungen, kurzspanend	Aluminium alloys, short chipping	- 400	LW610 ¹⁾	400	250	200	55
Kupfer-Legierungen, langspanend	Copper alloys, long chipping	300 – 700	LC225S	500	350	250	50
Kupfer-Legierungen, kurzspanend	Copper alloys, short chipping	500	LC225S	300	250	200	35
Magnesium-Legierungen	Magnesium alloys	150 – 300	LW610 ¹⁾	400	300	200	50
Thermoplaste	Thermoplastics	40 – 70	LW610 ¹⁾	250	250	250	70
Duroplaste	Duroplastics	20 – 40	LW610 ¹⁾	200	200	200	35
Graphit	Graphite						
Titan-Legierungen, mittelfest	Titanium alloys, medium strength	- 950	LW610 ¹⁾	100	80	-	20
Titan-Legierungen, hochfest	Titanium alloys, high strength	900 – 1400	LW610 ¹⁾	60	40	-	16
Nickelbasis-Legierungen, mittelfest	Nickel based alloys, medium strength	- 950	LC225S	80	60	-	18
Nickel-Basis-Legierungen, hochwarmfest	Heat resistant nickel based alloys, high strength	900 – 1400	LC240T	50	30	-	15
Hartguss	Chilled cast iron	300 – 600 HB	LC240T	40	30	-	24

¹⁾ Unbeschichtete HM-Sorte, v_c-Wert der Tabelle ist gültig für diese Sorte

¹⁾ Uncoated grade, value of v_c is valid for this grade

²⁾ Alternativ LW610 (unbeschichtet) verwenden, dann v_c-Wert um 30 % reduzieren

²⁾ Use alternatively LW610 (uncoated) and reduce v_c by 30 %

³⁾ Bei Verwendung von Kühlschmierstoffen mit HM-Sorte LC444W

³⁾ When using liquid coolants with carbide grade LC444W

Beim Einsatz unbeschichteter Sorten Schnittgeschwindigkeit um 30 % reduzieren.

When using uncoated grades reduce cutting speed by 30 %.

Technische Hinweise Technical hints

Empfohlene maximale Zahnvorschübe f_z (mm) bei $a_e = 0,75 \times d_1$
(Gleichlaufräsen)
Recommended maximum feed per tooth f_z (mm) for $a_e = 0,75 \times d_1$
(Climb milling)

	Cat.-No.					
	FMH 45 B (11171)	FMH 45 (11172)	FMH 45 A (11173)	FMT 45 (11250-09)	FMT 45 (11250-12) (11250-12 EF)	FMU 45 (11280)
$a_{p \max}$	5,5	5,5	5,5	5	7	5
α	45°	45°	45°	45°	45°	45°
ISO-Code	SEHW 1204 AF	SEKN 1203 AF	SEKN 1204 AF	SNKX 0904 AN	SNKX 1205 AN	SNHX 1205 AE
	0,3	0,25	0,3	0,3	0,4	0,3
	0,15	0,15	0,15	0,15	0,15	0,15
	0,4	0,3	0,4	0,4	0,5	–
	0,5	0,4	0,5	0,5	0,6	0,5
	0,25	0,2	0,25	0,25	0,3	0,3

	Cat.-No.			
	FMT 90 11260-09	FMT 90 11260-12	FMH 90 11415	FMU 90 11475-IK
$a_{p \max}$	8	10	8	12
α	90°	90°	90°	90°
ISO-Code	SPKX 1205	SPKX 120508	APKT 1003	ADHX 12T306
	0,2 – 0,3	0,3 – 0,4	0,15	0,2
	0,15	0,15	0,1	0,15
	0,2	0,3	0,25	0,3
	0,3	0,35	0,3	0,4
	0,15	0,15	–	0,2

Tauchfräsen Ramping

Schrägungswinkel W_1 max beim Tauchfräsen (Ramping)
Bevel angle W_1 max. for plunge milling "ramping"

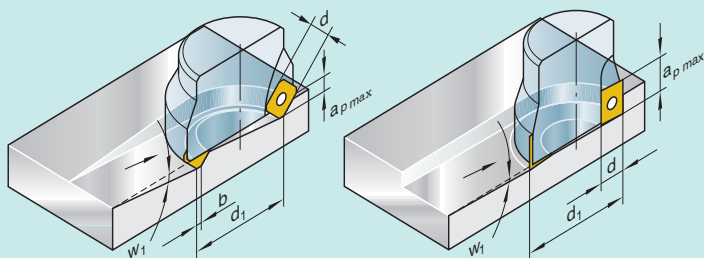

	FMT45 Twincut 45°			FMU90 Univex 90°
	d	9,52	12,7	19,05
b	1,5	2	3	
$a_{p \max}$	5	7	10	12
d_1 mm	W_1 max Grad Degree			
25	10,8	17,0		
32	7,8	12,0		
40	6,0	9,0		1,2
50	4,6	7,0		0,9
63	3,6	5,0		0,7
80	2,8	4,0	6,0	0,5
100		3,0	4,6	
125		2,5	3,6	
160		2,0	2,8	
innere Schnitttiefe inner cutting depth $\approx 0,7 \times a_{p \max}$				

Formeln Formulas

Drehzahl Speed n (min^{-1}):

$$n = \frac{v_c \cdot 1000}{\pi \cdot d_1}$$

Schnittgeschwindigkeit Cutting speed

$$v_c \text{ (m/min): } v_c = \frac{n \cdot \pi \cdot d_1}{1000}$$

v_c = Schnittgeschwindigkeit Cutting speed (m/min)

n = Drehzahl (min^{-1}) Speed (min^{-1})

d_1 = Fräser-Durchmesser (mm) Cutter dia. (mm)

v_f = Vorschubgeschwindigkeit Feed rate (mm/min)

f_z = Vorschub pro Zahn Feed per tooth (mm)

P_e = Antriebsleistung Drive power

z_{eff} = effektive Zähnezahl Effective number of teeth

f_2 = Korrekturfaktor für v_f Correction factor

Q = Spanvolumen Chip volume (cm^3/min)

a_e = Schnittbreite Width of cut (mm)

a_p = Schnitttiefe Depth of cut (mm)

LF = Leistungsfaktor Efficiency factor ($\text{cm}^3/\text{min}/\text{kW}$)

Vorschubgeschwindigkeit Feed rate

v_f (mm/min):

$$v_f = f_z \cdot z_{\text{eff}} \cdot n \cdot f_2$$

Vorschub pro Zahn Feed per tooth

$$f_z \text{ (mm): } f_z = \frac{v_f}{z_{\text{eff}} \cdot n \cdot f_2}$$

Spanvolumen Chip volume Q (cm^3/min):

$$Q = \frac{a_e \cdot a_p \cdot v_f}{1000}$$

Antriebsleistung Drive power

$$P_e \text{ (kW): } P_e = \frac{Q}{LF}$$

Werkstoff	Material	R _m (N/mm ²)	HM-Sorte Carbide Grade	Schnittgeschwindigkeit Cutting speed	
				Planfräsen Face milling vc m/min	Kopierfräsen Copy milling vc m/min
Unlegierter Baustahl	Plain carbon steel	- 700	LC240T	160 – 220	250 – 300
Automatenstahl	Free cutting steel	- 700	LC610T	160 – 220	250 – 300
Baustahl	Structural alloy steel	500 – 950	(Schlichten)	160 – 200	250 – 300
Vergütungsstahl, mittelfest	Heat-treatable steel, medium strength	500 – 950	(Finishing)	140 – 180	250 – 300
Stahlguss	Cast steel	- 950		140 – 180	250 – 300
Einsatzstahl	Case hardening steel	- 950		140 – 180	250 – 300
Rost- und säurebeständiger Stahl, ferritisch, martensitisch	Stainless steel, ferritic, martensitic	500 – 950		140 – 170	250 – 300
Vergütungsstahl, hochfest	Heat-treatable steel, high strength	950 – 1400	LC240T LC610T	120 – 150	180 – 220
Nitrierstahl, vergütet	Nitriding steel	950 – 1400	(Schlichten)	120 – 150	180 – 220
Werkzeugstahl	Tool steel	950 – 1400	(Finishing)	120 – 150	180 – 220
Rost- und säurebeständiger Stahl, austenitisch	Stainless steel, austenitic	500 – 950	LC240T	250 – 350 - 60 ²⁾	250 – 350 - 80 ²⁾
Martensitaushärtbarer Stahl	Maraging steel				
Grauguss	Grey cast iron	100 – 400	LC610T	130 – 210	200 – 300
Legierter Grauguss	Alloyed grey cast iron	150 – 250	LC610T	100 – 160	180 – 250
Sphäroguss	Nodular cast iron	400 – 800	LC610T	100 – 160	160 – 250
Temperguss	Malleable cast iron		LC610T	120 – 210	200 – 300
Rein-Metalle, weich	Pure metals, soft	- 500	LC225S	250 – 500	300 – 1000
Aluminium-Legierungen, langspanend	Aluminium alloys, long chipping	- 550	LW610 ¹⁾	300 – 1000	300 – 1000
Aluminium-Legierungen, kurzspanend	Aluminium alloys, short chipping	350 – 700	LW610 ¹⁾	200 – 300	200 – 300
Kupfer-Legierungen, langspanend	Copper alloys, long chipping	300 – 700	LC225S	250 – 500	300 – 1000
Kupfer-Legierungen, kurzspanend	Copper alloys, short chipping		LC225S	200 – 300	200 – 300
Magnesium-Legierungen	Magnesium alloys	- 400	LW610 ¹⁾	200 – 400	200 – 500
Thermoplaste	Thermoplastics	40 – 70	LW610 ¹⁾	200 – 400	300 – 1000
Duroplaste	Duroplastics	- 500	LW610 ¹⁾	180 – 250	200 – 300
Graphit	Graphite				
Titan-Legierungen, mittelfest	Titanium alloys, medium strength	150 – 300	LW610 ¹⁾	40 – 80	40 – 100
Titan-Legierungen, hochfest	Titanium alloys, high strength	20 – 40	LW610 ¹⁾	30 – 50	40 – 80
Nickelbasis-Legierungen, mittelfest	Nickel based alloys, medium strength	- 950			
Nickel-Basis-Legierungen, hochwarmfest	Heat resistant nickel based alloys, high strength	900 – 1040			
Hartguss	Chilled cast iron	900 – 1400	LC240T	30 – 40	40 – 80

¹⁾ Unbeschichtete HM-Sorte, v_c-Wert der Tabelle ist gültig für diese Sorte

¹⁾ Uncoated grade, value of v_c is valid for this grade

²⁾ Bei Verwendung von Kühlschmierstoffen

²⁾ When using liquid coolants

Technische Hinweise Technical hints

Anwendungsempfehlungen Twincut-Vario und FCT45 Application options Twincut Vario and FCT45

Planfräsen Face milling					
	Cat.-No.				
	FCT45 rund round	FCTXX rund/rund round/round	FCT45 8-kant octagonal	FCTXX 8-kant/8-kant octagonal/octagonal	FCT45 12-kant englisch!!
$a_{p \max}$	8 ¹⁾	8	10 ²⁾	10	9 ³⁾
$a_{p \min}$	0	2	0	2	0
ISO-Code	RCKX 1606 MO-TR		OCKX 0606 AD-TR		XCKX 1606 ZDR-TR
Empfohlene maximale Vorschübe pro Wendepatte f_z in mm Recommended maximum feeds per insert f_z in mm					
	0,45		0,35		
	0,40		0,30		
	0,20		0,15		
	0,40		0,30		

¹⁾ bei 2 mm, 8-fach wendbar with 2 mm 8 times usable

²⁾ bei 3 mm, 8-fach wendbar with 3 mm 8 times usable

³⁾ bei 1 mm, 12-fach wendbar with 1 mm 12 times usable

Tauchfräsen und axiales Eintauchen Plunge milling with axial entry

Schrägungswinkel W_1 max. beim Tauchfräsen (Ramping) mit Twincut Vario
Max. W_1 angle when ramping with Twincut Vario

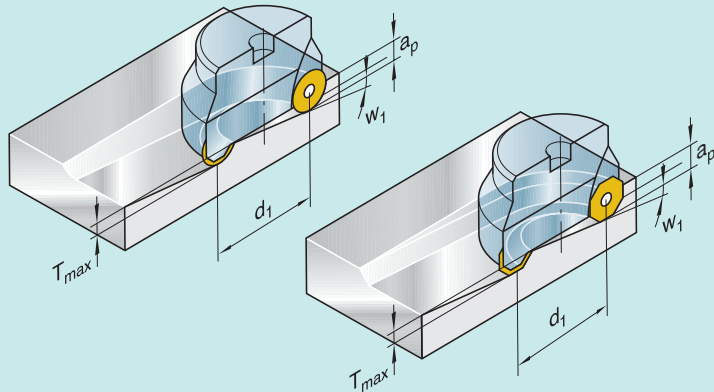

d_1	FCTXX mit with RCKX 1606 MO-TR	FCT45 mit with OCKX 0606 AD-TR	FCTXX mit with OCKX 0606 AD-TR	FCT45 mit with OCKX 0606 AD-TR
	W_1°	W_1°	W_1°	W_1°
36	5,4		6	
50	3,5		3,9	
52		7,0		8,1
63	2,6	4,8	2,9	5,4
80	2	3,6	2,2	4,0
100	1,5	2,7	1,7	3,0
125	1,2	2,0	1,3	2,2°

Innere Schnitttiefe $T_{\max} = 4$ mm
Internal cut depth $T_{\max} = 4$ mm

Zirkularfräsen Circular milling

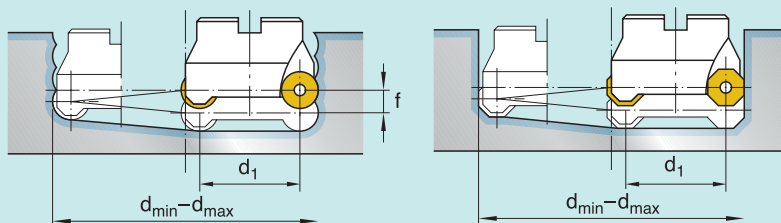

**Durchmesserbereich für das Bohrfräsen
in einem Durchgang**
**Diameter range for countersinking
in one operation**

d_1	FCTXX		FCT45	
	d_{\min}	d_{\max}	d_{\min}	d_{\max}
36	73,5	111		
50	94,5	139		
52			73,5	104
63	115	167		
66			101,5	132
80	139,5	199	129,5	160
100	169,5	239	169,5	200
125	207	289	219,5	250



Schaft- und Walzenstirnfräser

End and Shell End Mills

Auswahlübersicht Selection table	146
Univex-Fräser Univex Cutters	148
Schaftfräser für ISO-Wendeplatten End Mills for ISO Indexable Inserts	156
Bohrnutenfräser Slot Drills	158
Twincut-Schrupfräser Twincut Roughing End Mills	160
Fasenfräser Bevel Milling Cutters	162
T-Nutenfräser T-Slot Cutters	166
Schrupp-Walzenstirnfräser Roughing Shell End Mills	168
Gewindefräser Thread Milling Cutters	170
Schnittwertempfehlungen Cutting data recommendations	172

Auswahlübersicht Selection table

Schaft- und Walzenstirnfräser End and Shell End Mills

	Cat.-No.			Nenn-Ø Nominal-Ø	Seite Page
	EMU90 11473-1K	Schaftfräser Univex 90° End Mills Univex 90°	ADHX 	12 – 40	148
	EMU90 11474-1K			25 – 40	151
	EMU90 11472			16 – 40	149
	ERU90 11552	Schrupfräser Rechtsdrall Univex Roughing End Mills Right hand helix Univex	ADHX 	25 – 32	152
	ERU90 11555			25 – 63	155
	FRU90 11335			50 – 63	155
	EMH90 11412	Schaftfräser 90° End Mills 90°	APKT 1003 	16 – 25	156
			APKT 1603 	16 – 40	156
	ESP90 11470	Bohrnutenfräser Slot Drills	CCHX 	11,7 – 31,7	158

Auswahlübersicht Selection table

Schaft- und Walzenstirnfräser End and Shell End Mills

	Cat.-No.			Nenn-Ø Nominal-Ø	Seite Page
	ERT90 11256	Schruppfräser Linksdrall Twincut Roughing End Mills Left hand helix Twincut	SNKX 	32	160
	ERT90 11257			32 – 50	161
	FRT90 11259			50 – 80	161
	EFZ 1148	Fasenfräser 30° – 45° – 60° Bevel Milling Cutters 30° – 45° – 60°	TCMT 	16 – 32	162
	EFZ45 11483	Fasenfräser 45° Bevel Milling Cutters 45°	SPMW 	28 – 49	164
	EFZ45 11481			36	165
	ESP90 11403-IK	T-Nutenfräser T-Slot Cutters	CCMT 	25 – 50	166
	ETZ90 11440-IK	Gewindefräser Thread Milling Cutters		16 – 36	170
	FRP90 1133	Schruppfräser Rechtsdrall Roughing End Mills Right hand helix	SPMW 	50 – 125	168

- 1 Rhombische Form für große Schnittiefen
1 Rhombic shape for large depths of cut
- 2 Konvexe Planfase an den Schneidenecken für hohe Oberflächengüte
2 Convex flat land on the cutting edge corners gives high surface finish
- 3 Exaktes 90°-Eckfräsen, auch bei positiver Anstellung der Wendeplatte. Konvexer Anschlag der Schneide erzeugt exakt gerade Wandungen der gefrästen Nut, trotz hohem positiven Axialwinkel
3 Accurate 90° angle milling, even with positive setting of the indexable insert. Convex grinding angle of the cutting edge produces accurate straight walls of the milled slot, in spite of high positive axial rake angle.

- 4 Allseitig präzisionsgeschliffen, dadurch hohe Rund- und Planlaufgenauigkeit.
4 Precision ground on all sides, gives excellent true running on o.d. and face.
- 5 Spezieller schräger Hohlkehlenanschliff für konstanten positiven Spanwinkel über die gesamte Schneidkante.
5 Special chip groove grinding gives constant positive rake over the entire cutting edge length.
- 6 Hoher Axialwinkel.
6 High axial rake angle.
- 7 Sicherer und genauer Plattensitz mit Dreipunktanlage.
7 Secure and accurate insert seat with three point support.

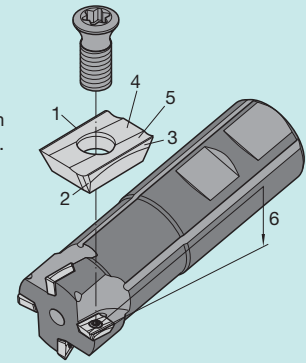

N = Anzahl der Schneidkanten N = Number of cutting edges						ISO-Code Cat-No.	Schneidstoffsorten Cutting materials Ident No.											Für Fräser For cutter Cat-No.						
	l	s	d	d ₁	b/r		LC240T	LC240S	LC230F	LC225T	LC225S	LC630T	LW240	LW225	LC440T	LC444W	LC610E		LC610T	LC610W	LC610A	LW610	LC603Z	
 N = 2	9,52	2,87	6,35	2,8	0,4	ADHX 090304 ER 1196-80	1069401	1069453	1068001		1069443		1069451	1069441	1067540			1069486			1069442	1069485	EMU90 ERU90	
	9,52	2,87	6,35	2,8	0,8	ADHX 090308 ER 1196-80 R03					1960082										1960080	1960083		
	9,52	2,87	6,35	2,8	1,5	ADHX 090315 ER 1196-80 R06					1960085										1960083	1960083		
	9,52	2,87	6,35	2,8	0,4	ADMX 090304 ER 1196-81	1069522	1069382			1069454		1069381	1069450				1069490			1069452	1069452		
	11,1	3,18	7,94	3,4	0,5	ADHX 110305 ER 1196-82	1069402	1069459	1068002		1069446		1069457	1069444	1067541			1069490			1069445	1069445	1069487	EMU90 ERU90
	11,1	3,18	7,94	3,4	0,8	ADHX 110308 ER 1196-82 R03					1960072			1960071							1960070	1960070		
	11,1	3,18	7,94	3,4	1,5	ADHX 110315 ER 1196-82 R06					1960075			1960074							1960073	1960073		
	11,1	3,18	7,94	3,4	0,5	ADMX 110305 ER 1196-83	1069528	1069384			1069387		1069383	1069456				1069529			1069485	1069485		
	9,52	2,87	6,35	2,8	0,4	ADKX 0903 PESR-BP 1196-87	1055004		1058013		1055002		1055003	1055001				1055006					EMU90 ERU90	
	11,1	3,18	7,94	3,4	0,5	ADKX 1103 PESR-BP 1196-88	1055010		1058014		1055008		1055009	1055007				1055012						
	9,52	2,87	6,35	2,8	0,4	ADHX 090304 FR-ALC 1196-80 ALC												1069532			1069531		EMU90 ERU90	
	11,1	3,18	7,94	3,4	0,5	ADHX 110305 FR-ALC 1196-82 ALC												1069534			1069533			

¹⁾ Andere Eckenradien auf Anfrage
¹⁾ Other corner radii on request

Sortenbeschreibung/-bezeichnung und ISO-Code ab Seite 22
Description/Designation of grades and ISO-Code starting page 22

Univex-Aufschraubfräser
Univex Screw-On Type End Mills

EMU90 11472												
d ₁	l ₁	l ₃	d ₅	d ₃	d ₂ h ₆	z	Ident No.	LMT-Code		Ident No.	Ident No.	
16	9	25	12	M 8	8,2	2	1039750	EMU90 A09.019TD	ADHX 090304 ER 1196-80	1044972	1048326	
16	9	25	13	M 8	8,5	2	1039759	EMU90 A09.016TR				
20	9	26	16	M10	10,2	3	1039751	EMU90 A09.020TE				
20	9	26	18	M10	10,5	3	1039761	EMU90 A09.020TS				
25	10,5	33	21	M12	12,5	3	1039752	EMU90 A11.025TF				
32	10,5	43	26	M16	17	4	1039753	EMU90 A11.032TH	ADHX 110305 ER	2237513	1048326	
40	10,5	43	34	M16	17	5	1039757	EMU90 A11.040TH	1196-82			

Verlängerungsdorne und Anschlußmaße siehe LMT-Katalog „Spannen“ ab Seite 221
 Extension arbors and fitting dimensions refer LMT Catalogue “Chucking” starting page 221

Univex-Schaftfräser
Univex End Mills

EMU90 11473-IK												
IK = Innere Kühlmittelzufuhr IK = Internal coolant supply												
d ₁	l ₂	l ₁	l ₃	d ₂	z	Ident No.	LMT-Code		Ident No.	Ident No.		
12	9	76	28	16	1	1039754	EMU90 A09.012BR-I	ADHX 090304 ER 1196-80	1044972	1048326		
14	9	76	28	16	1	1039755	EMU90 A09.014BP-I					
16	9	76	28	16	2	1039756	EMU90 A09.016BN-I					
18	9	76	28	16	2	1039758	EMU90 A09.018BL-I					
20	9	86	36	20	2	1039775	EMU90 A09.020BN-IW					
20	9	86	36	20	3	1039760	EMU90 A09.020BN-I	ADHX 110305 ER 1196-82	2237513	10488326		
22	9	86	36	20	3	1039762	EMU90 A09.022BL-I					
25 ¹⁾	10,5	86	36	20	3	1039765	EMU90 A11.025BN					
25	10,5	96	40	25	3	1039764	EMU90 A11.030BN-I					
30 ¹⁾	10,5	86	36	20	4	1039769	EMU90 A11.030BD					
30	10,5	96	40	25	4	1039768	EMU90 A11.030BI-I					
32 ¹⁾	10,5	86	36	20	4	1039771	EMU90 A11.032BB					
32	10,5	96	40	25	4	2275652	EMU90 A11.032BG-I					
32	10,5	110	50	32	4	1039770	EMU90 A11.032BN-I					
40	10,5	110	50	32	5	1039774	EMU90 A11.040BF-I					

¹⁾ ohne
¹⁾ without IK

Schnittwertempfehlungen ab Seite 172
 Cutting data recommendations starting page 172

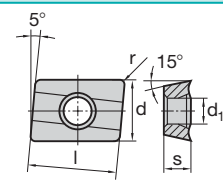
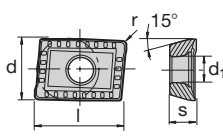
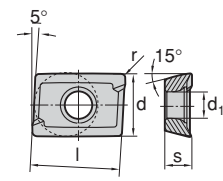
N = Anzahl der Schneidkanten N = Number of cutting edges						ISO-Code Cat-No.	Schneidstoffsorten Cutting materials Ident No.											Für Fräser For cutter Cat-No.							
	l	s	d	d ₁	b/r		LC240T	LC240S	LC230F	LC225T	LC225S	LC630T	LW240	LW225	LC440T	LC444W	LC610E		LC610T	LC610W	LC610A	LW610	LC603Z		
 <p>N = 2</p>	9,52	2,87	6,35	2,8	0,4	ADHX 090304 ER 1196-80	1069401	1069453	1068001		1069443		1069451	1069441	1067540			1069486			1069442	1069485	EMU90 ERU90		
	9,52	2,87	6,35	2,8	0,8	ADHX 090308 ER 1196-80 R03					1960082			1960081							1960080				
	9,52	2,87	6,35	2,8	1,5	ADHX 090315 ER 1196-80 R06					1960085			1960084							1960083				
	9,52	2,87	6,35	2,8	0,4	ADMX 090304 ER 1196-81	1069522	1069382			1069454		1069381	1069450				1069490				1069452			
	11,1	3,18	7,94	3,4	0,5	ADHX 110305 ER 1196-82	1069402	1069459	1068002		1069446		1069457	1069444	1067541			1069490				1069445		1069487	EMU90 ERU90
	11,1	3,18	7,94	3,4	0,8	ADHX 110308 ER 1196-82 R03					1960072			1960071							1960070				
	11,1	3,18	7,94	3,4	1,5	ADHX 110315 ER 1196-82 R06					1960075			1960074							1960073				
	11,1	3,18	7,94	3,4	0,5	ADMX 110305 ER 1196-83	1069528	1069384			1069387		1069383	1069456				1069529				1069485			
	9,52	2,87	6,35	2,8	0,4	ADKX0903PESR-BP 1196-87	1055004	1055003		1055002		1055003	1055001				1055006						EMU90 ERU90		
	11,1	3,18	7,94	3,4	0,5	ADKX1103PESR-BP 1196-88	1055010	1058014		1055008		1055009	1055007				1055012								
	9,52	2,87	6,35	2,8	0,4	ADHX 090304 FR-ALC 1196-80 ALC											1069532				1069531		EMU90 ERU90		
	11,1	3,18	7,94	3,4	0,5	ADHX 110305 FR-ALC 1196-82 ALC											1069534				1069533				

¹⁾ Andere Eckenradien auf Anfrage
¹⁾ Other corner radii on request

Sortenbeschreibung/-bezeichnung und ISO-Code ab Seite 22
Description/Designation of grades and ISO-Code starting page 22

IK = Innere Kühlmittelzufuhr IK = Internal coolant supply													
d ₁	l ₂	l ₁	l ₃	SK	z	Ident No.	LMT-Code		Ident No.	Ident No.			
25	10,5	138	70	40	3	1039784	EMU90 A11.025HA-I	ADHX 110305 ER 1196-82	2237413	1048326			
28	10,5	138	70	40	3	1039786	EMU90 A11.028HA-I						
30	10,5	151	83	40	4	1039788	EMU90 A11.030HA-I						
32	10,5	151	83	40	4	1039790	EMU90 A11.032HA-I						
36	10,5	159	91	40	4	1039792	EMU90 A11.036HA-I						
40	10,5	159	91	40	5	1039794	EMU90 A11.040HA-I						

Schnittwertempfehlungen ab Seite 172
 Cutting data recommendations starting page 172

- 1 Spezielle Hohlkehlenform für konstanten, positiven Spanwinkel über die gesamte Schneidlänge.
- 1 Special chip groove form for constant positive rake over the entire cutting length.
- 2 Volle Überdeckung innerhalb einer Zahnreihe, Anordnung mit hohem Rechtsdrall.
- 2 Complete coverage in each flute, high R. H. helix.
- 3 Weiches Schneiden durch hohe positive Axialwinkel, gute Spanförderung.
- 3 Smooth cutting action by high positive axial angle, good chip removal.

- 4 Konvexe Schneiden ergeben exakte Zylinderform.
- 4 Convex cutting edges give precise cylindrical form.
- 5 Anschlag gegen axiales Verschieben der Wendepalten.
- 5 End stop to provide axial movement of the inserts.
- 6 Erhöhte Schneidenzahl im Stirnbereich. Nur eine Plattenform, als Stirn- oder Umfangsplatte einsetzbar.
- 6 Increased number of cutting edges at face end, only one size for face end and peripheral inserts.

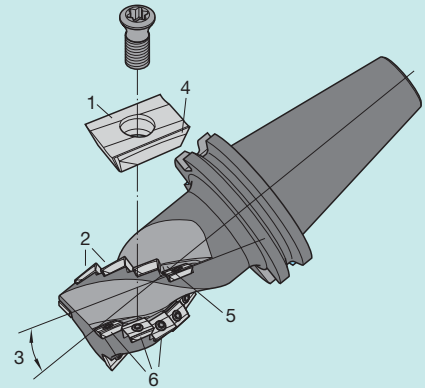

							Schneidstoffsorten Cutting materials											Für Fräser For cutter							
							Ident No.																		
N = Anzahl der Schneidkanten N = Number of cutting edges	l	s	d	d ₁	b/r	ISO-Code Cat-No.	LC240T	LC240S	LC230F	LC225T	LC225S	LC630T	LW240	LW225	LC440T	LC444W	LC610E	LC610T	LC610W	LC610A	LW610	LC603Z	Cat-No.		
<p>N = 2</p>	9,52	2,87	6,35	2,8	0,4	ADHX 090304 ER 1196-80	1069401	1069453	1068001		1069443		1069451	1069441	1067540			1069486				1069442	1069485	EMU90 ERU90	
	9,52	2,87	6,35	2,8	0,8	ADHX 090308 ER 1196-80 R03					1960082											1960080	1960083		
	9,52	2,87	6,35	2,8	1,5	ADHX 090315 ER 1196-80 R06					1960085												1960083		
	9,52	2,87	6,35	2,8	0,4	ADMX 090304 ER 1196-81	1069522	1069382			1069454	1069454		1069381	1069450			1069490				1069452	1960083		
	11,1	3,18	7,94	3,4	0,5	ADHX 110305 ER 1196-82	1069402	1069459	1068002		1069446	1069446		1069457	1069444	1067541			1069490			1069445	1960070	1069487	EMU90 ERU90
	11,1	3,18	7,94	3,4	0,8	ADHX 110308 ER 1196-82 R03					1960072				1960071								1960070		
	11,1	3,18	7,94	3,4	1,5	ADHX 110315 ER 1196-82 R06					1960075				1960074								1960073		
	11,1	3,18	7,94	3,4	0,5	ADMX 110305 ER 1196-83	1069528	1069384			1069387		1069383	1069456				1069529			1069485	1960073			
	9,52	2,87	6,35	2,8	0,4	ADKX 0903 PESR-BP 1196-87	1055004		1058013		1055002		1055003	1055001				1055006						EMU90 ERU90	
	11,1	3,18	7,94	3,4	0,5	ADKX 1103 PESR-BP 1196-88	1055010		1058014		1055008		1055009	1055007					1055012						
	9,52	2,87	6,35	2,8	0,4	ADHX 090304 FR-ALC 1196-80 ALC												1069532				1069531		EMU90 ERU90	
	11,1	3,18	7,94	3,4	0,5	ADHX 110305 FR-ALC 1196-82 ALC													1069534				1069533		

¹⁾ Andere Eckenradien auf Anfrage
¹⁾ Other corner radii on request

Sortenbeschreibung/-bezeichnung und ISO-Code ab Seite 22
Description/Designation of grades and ISO-Code starting page 22

ERU90 11552												
d ₁	l ₂	l ₃	l ₁	d ₂ h ₆	z	Ident No.	Stck. Pcs.	LMT-Code		Ident No.	Ident No.	
25	16	36	86	20	2	1042662	4	ERU90 A09.025BI	ADMX 090304 ER	1044972	1048326	
25	25	44	100	25	2	1042659	6	ERU90 A09.025BN	1196-81			
32	37	55	115	32	2	1042660	8	ERU90 A11.032BN	ADMX 110305 ER	2237513	1048326	
									1196-83			

Schnittwertempfehlungen ab Seite 172
Cutting data recommendations starting page 172

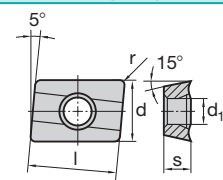
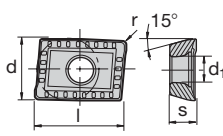
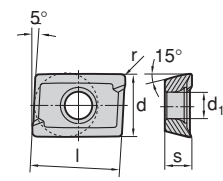
N = Anzahl der Schneidkanten N = Number of cutting edges						ISO-Code Cat-No.	Schneidstoffsorten Cutting materials Ident No.											Für Fräser For cutter Cat-No.					
	l	s	d	d ₁	b/r		LC240T	LC240S	LC230F	LC225T	LC225S	LC630T	LW240	LW225	LC440T	LC444W	LC610E		LC610T	LC610W	LC610A	LW610	LC603Z
 <p>N = 2</p>	11,1	3,18	7,94	3,4	0,5	ADHX 110305 ER 1196-82	1069402	1069459	1068002		1069446		1069457	1069444	1067541		1069490			1069445		EMU90 ERU90	
	11,1	3,18	7,94	3,4	0,8	ADHX 110308 ER 1196-82 R03					1960072			1960071						1960070			
	11,1	3,18	7,94	3,4	1,5	ADHX 110315 ER 1196-82 R06					1960075			1960074						1960073			
	11,1	3,18	7,94	3,4	0,5	ADMX 110305 ER 1196-83	1069528	1069384			1069387		1069383	1069456				1069529			1069485		
	12,7	3,97	9,52	4	0,6	ADHX 12T306 ER 1196-84	1069403	1069463	1068003		1069449		1069461	1069447	1067542			1069492			1069448		ERU90 FMU90 FRU90
	12,7	3,97	9,52	4	1,5	ADHX 12T315 ER 1196-84 R06					1960092			1960091									
	12,7	3,97	9,52	4	2,3	ADHX 12T323 ER 1196-84 R09					1960095			1960094									
	12,7	3,97	9,52	4	0,6	ADMX 12T306 ER 1196-85	1069526	1069386			1069468		1069385	1069462				1069530			1069466		
	11,1	3,18	7,94	3,4	0,5	ADKX1103PESR-BP 1196-88	1055010		1058014		1055008		1055009	1055007					1055012			EMU90 ERU90	
	12,7	3,97	9,52	4	0,6	ADKX12T3PE 1196-89	1055016		1058015		1055014		1055015	1055013						1055018			ERU90 FMU90 FRU90
	11,1	3,18	7,94	3,4	0,5	ADHX 110305 FR-ALC 1196-82 ALC													1069534			EMU90 ERU90	
	12,7	3,97	9,52	4	0,6	ADHX 12T306 FR-ALC 1196-84 ALC													1069536		1069535		ERU90 FMU90 FRU90
<p>1) Andere Eckenradien auf Anfrage 1) Other corner radii on request</p>																							

Sortenbeschreibung/-bezeichnung und ISO-Code ab Seite 22
Description/Designation of grades and ISO-Code starting page 22

ERU90 11555											
d ₁	l ₂	l ₃	l ₁	SK	z	Ident No.	Stck. Pcs.	LMT-Code		Ident No.	Ident No.
32	37	80	148	40	2	1042647	8	ERU90 A11.032HA	ADMX 110305 ER 1196-83	2237413	1048326
40	45	90	158	40	3	1042649	15	ERU90 A11.040HA			
50	60	102	170	40	3	1042654	18	ERU90 A12.050HA	ADMX 12T306 ER 1196-85	1055114	1048335
50	60	113	215	50	3	1042650	18	ERU90 A12.050HN			

Verlängerungsdorne und Anschlußmaße siehe LMT-Katalog „Spannen“ ab Seite 221
Extension arbors and fitting dimensions refer LMT Catalogue “Chucking” starting page 221

Univex-Walzenstirfräser
Univex Roughing Shell End Mills

FRU90 11335											
d ₁	l ₂	l ₁	d ₂	Anzugsgewinde Arbor screw DIN 912	z	Ident No.	Stck. Pcs.	LMT-Code		Ident No.	Ident No.
50	28	50	22	M10 x 25	3	1035094	9	FRU90 A12.050ANS	ADMX 12T306 ER 1196-85	1045114	1048335
50	50	71	22	M10 x 40	3	1035093	15	FRU90 A12.050AN			
63	32	50	27	M12 x 30	4	1035096	12	FRU90 A12.063ANS			
63	54	71	27	M12 x 45	4	1035095	20	FRU90 A12.063AN			

Schnittwertempfehlungen ab Seite 172
Cutting data recommendations starting page 172

Besondere Merkmale:

- Universell einsetzbar
- Zum Nuten- und Kantenfräsen
- Für ein breites Spektrum von Werkstoffen
- Stabile Wendeplatte
- Große Schneidenlänge
- Positive Schneidengeometrie
- Hohe Schneidkantenstabilität

Special features:

- Universal application
- To mill slots and edges
- For a wide range of materials
- Stable indexable inserts
- Large cutting length
- Positive cutting geometry
- High cutting edge stability

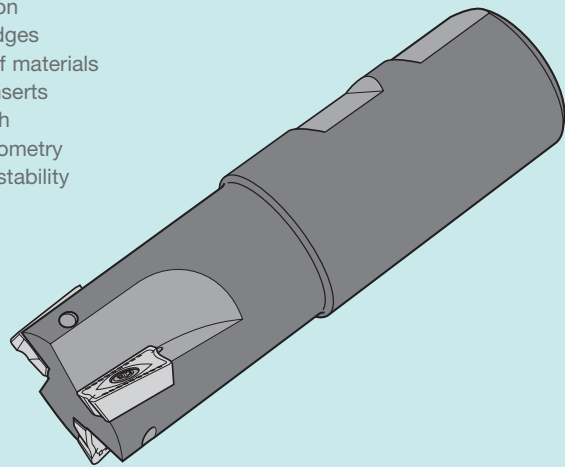

N = Anzahl der Schneidkanten N = Number of cutting edges						ISO-Code	Schneidstoffsorten Cutting materials								Für Fräser For cutter Cat-No.							
	l	s	d	d ₁	b/r		LC240T	LC230F	LC225T	LC225S	LW225	LC440T	LC444W	LC610E		LC610T	LC610T	LC610A	LW610			
 N = 2	10,96	3,5	6,6	2,8	0,5	APHT 1003PDFR-ALC													●	●	FMH90 A10	
	17,3	5,26	9,52	4,5	0,8	APHT 1604PDFR-ALC													●	●	FMH90 A16	
 N = 2	10,96	3,5	6,6	2,8	0,5	APKT 1003PDSR-BM							●								FMH90 A10	
	17,3	5,26	9,52	4,5	0,8	APKT 1604PDSR-BM							●									FMH90 A16
 N = 2	10,96	3,5	6,6	2,8	0,5	APKT 1003PDSR-BP	●	●	●	●	●	●									FMH90 A10	
	17,3	5,26	9,52	4,5	0,8	APKT 1604PDSR-BP	●	●	●	●	●	●									FMH90 A16	
	17,3	5,26	9,52	4,5	1,6	APKT 160416SR-BP								●								
	17,3	5,26	9,52	4,5	2,4	APKT 160424SR-BP																
	17,3	5,26	9,52	4,5	3,2	APKT 160432SR-BP																

Sortenbeschreibung/-bezeichnung und ISO-Code ab Seite 22
Description/Designation of grades and ISO-Code starting page 22

EMH90 11412												
d ₁	l ₂	l ₁	l ₃	d ₂	z	Ident No.	LMT-Code		Ident No.	Ident No.		
16	8	76	28	16	2	1028506	EMH90 A10.016BN	APKT 1003 PDR	1044972	1048326		
20	8	86	36	20	2	1028507	EMH90 A10.020BN					
25	8	86	36	20	3	1028508	EMH90 A10.025BI					
25	14	86	36	20	2	1028504	EMH90 A10.025BI					
25	14	96	40	25	2	1028501	EMH90 A10.025BN	APKT 1604 PDR	1045131	1048335		
32	14	86	36	20	3	1028505	EMH90 A10.032BB					
32	14	110	50	32	3	1028502	EMH90 A10.032BN					
40	14	110	50	32	4	1028503	EMH90 A10.040BF					

Schnittwertempfehlungen ab Seite 172
 Cutting data recommendations starting page 172

Besondere Merkmale:

- Passungsgenaues Fräsen im Rahmenfräsverfahren
- Fräsen von Nuten nach DIN 6885 bei voller Schnitttiefe
- Sicherer Spanfluß auch beim Bohren durch besondere Wendelplattegeometrie
- Hohe Schnittleistungen

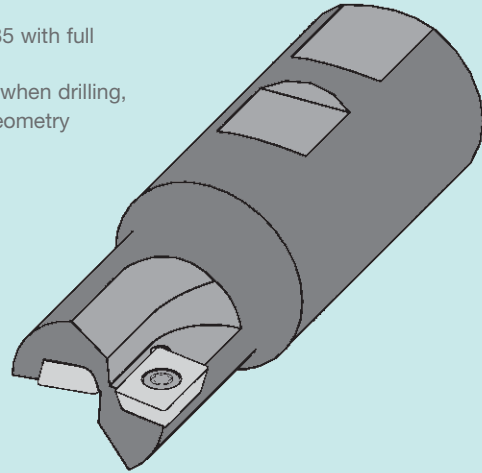

Special features:

- Milling to precision limits by contour milling
- Milling slots to DIN 6885 with full depth of cut
- Reliable chip flow also when drilling, due to special insert geometry
- High cutting rates

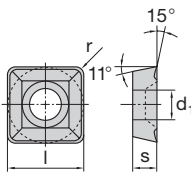
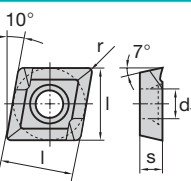
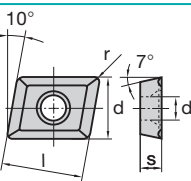

N = Anzahl der Schneidkanten N = Number of cutting edges						ISO-Code Cat-No.	Schneidstoffsorten Cutting materials Ident No.											Für Fräser For cutter Cat-No.						
	l	s	d	d ₁	b/r		LC240T	LC240S	LC230F	LC225T	LC225S	LC630T	LW240	LW225	LC440T	LC444W	LC610E		LC610T	LC610W	LC610A	LW610	LC603Z	
 N = 2	9,52	3,97		4,4	0,8	SPMT 09T308 1196-24		1069340						1069340									1069326	ESP90
 N = 2 s = ± 0,025 d = ± 0,01	7,94	2,78		3,4	0,3	CCHX 080203 1196-44								1069332									1069325	ESP90
	9,52	3,18		4,4	0,4	CCHX 090304 1196-54								1069338									1069390	
	12,7	3,97		5,5	0,5	CCHX 12T305 1196-64								1069334									1069399	
 N = 2 s = ± 0,025 l = ± 0,01 d = ± 0,01	14,3	3,97	9,52	4,4	0,5	1196-74								1069335									1069410	ESP90

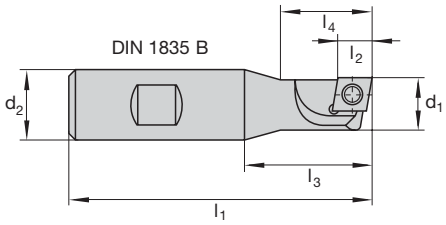
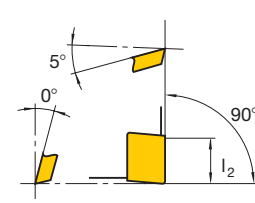
Sortenbeschreibung/-bezeichnung und ISO-Code ab Seite 22
Description/Designation of grades and ISO-Code starting page 22

ESP90 11470									  		
d ₁	l ₂	l ₁	l ₃	l ₄	d ₂ h ₆	z	Ident No.	LMT-Code		Ident No.	Ident No.
11,7	7	76	28	17	16	1	1039702	ESP90 C08.012BR	CCHX 080203 1196-44	1045127	1048326
13,7	7	76	28	16	16	1	1039704	ESP90 C08.014BP			
15,7	8,5	86	36	24	20	1	1039706	ESP90 C09.016BR	CCHX 090304 1196-54	1051277	1048335
17,7	8,5	86	36	28	20	1	1039708	ESP90 C09.018BP			
19,7	11	96	40	28	25	1	1039710	ESP90 C12.020BS	CCHX 12T305 1196-64	1045129	
21,7	11	96	40	28	25	1	1039712	ESP90 C12.022BQ			
24,7	13	96	40	36	25	1+1	1039714	ESP90 C14.025BN	Umfangsplatte Peripheral insert SPMT 09T308 1196-24 Zentrumsplatte Center insert	1045105	1048344
27,7	13	100	40	36	32	1+1	1039716	ESP90 C14.028BR			
31,7	13	100	40	36	32	1+1	1039718	ESP90 C14.032BN			

Schnittwertempfehlungen ab Seite 172
Cutting data recommendations starting page 172

Besondere Merkmale:

- Zum Umfangs- und Konturfraßen,
 $a_{e\ max.} \leq 0,5 \times d_1$
- Verwendung der TWINCUT-Wendepplatten
- Volle Überdeckung innerhalb einer Zahnreihe
- Besonders große Stabilität durch doppelt-negative Plattensitzlage und Linksdrall
- Als Sonderausführung auch in größeren Längen lieferbar

Special features:

- For contour milling,
 $a_{e\ max.} \leq 0,5 \times d_1$
- Using the TWINCUT-inserts
- Complete coverage within each flute
- Highest stability by double negative insert seat location and left hand helix
- Also available in longer lengths as special designs



N = Anzahl der Schneidkanten N = Number of cutting edges						ISO-Code Cat-No.	Schneidstoffsorten Cutting materials											Für Fräser For cutter Cat-No.					
	l	s	d	d ₁	b/r		LC240T	LC240S	LC230F	LC225T	LC225S	LC630T	LW240	LW225	LC440T	LC444W	LC610E		LC610T	LC610W	LC610A	LW610	LC603Z
 N = 4	9,52	4,76		4,4	1,5	SNKX 0904 AN 1187-00	1052316	1052294	1068006			1052284	1052282			1052233	1052339				1052236		FMT45 EBT X ERT90
	12,7	5,56		5,2	2	SNKX 1205 AN 1187-10	1052301	1052230	1068007	1052315	1052228					1052234	1052339				1052236		MMT45 MMT87 FMT45 FMT87 EBT X ERT90 FRT90
 N = 4	12,7	5,56		5,2	2	SNKX 1205 AN-TR 1187-10 TR	1052248	1052245		1052239	1052237						1052251				1052249		MMT45 MMT87 FMT45 FMT87 EBT X ERT90 FRT90
	 N = 4 breite Schneidkantenfase wide land	9,52	4,76		4,4	1,5	SNKX 0904 AN-TT	1055743 ¹⁾															
12,7		5,44		5,2	2	SNKX 1205 AN-T 1187-12	1052303	1052258	1068008	1052314	1052256						1052309				1052254		MMT45 MMT87 FMT45 FMT87 EBT X ERT90 FRT90
 N = 4	12,7	5,56		5,2	2	SNKX 1205 AN-TT breite Schneidkantenfase wide land	1055742 ¹⁾																MMT45 MMT87 FMT45 FMT87 EBT X ERT90 FRT90

¹⁾ LC280TT Schrappgeometrie mit 2-fach Beschichtung
Roughing geometry with double coating

Sortenbeschreibung/-bezeichnung und ISO-Code ab Seite 22
Description/Designation of grades and ISO-Code starting page 22

ERT90 11256																
d ₁	l ₂	l ₁	l ₃	d ₂	z	Ident No.	Stck. Pcs.	LMT-Code		Ident No.	Ident No.					
32	47	123,8	125	32	2	1027381	14	ERT90 S09.032BN	SNKX 0904 AN 1187-00	1052282	1048335					

ERT90 11257																
d ₁	l ₂	l ₁	l ₃	SK	z	Ident No.	Stck. Pcs.	LMT-Code		Ident No.	Ident No.					
32	47	157,2	106	40	2	1027372	14	ERT90 S09.032HA	SNKX 0904 AN 1187-00	1052282	1048335					
40	54	162,2	118	40	3	2346622	24	ERT90 S09.040HA								
40	54	207,2	106	50	3	1027373	24	ERT90 S09.040HB								
50	61	215,2	118	50	4	1027376	36	ERT90 S09.050HB	SNKX 1205 AN 1187-10	1045123	10487344					
50	62	208	106	50	2	1027370	14	ERT90 S12.050HB								
63	70	220	118	50	3	1027371	24	ERT90 S12.063HB								

FRT90 11259																
d ₁	l ₂	l ₁	d ₂	z	Ident No.	Stck. Pcs.	LMT-Code		Ident No.	Ident No.						
50	28	50	22	2	1027377	6	FRT90 S12.050ANS	SNKX 1205 AN 1187-10	1045123	1048344						
63	36	50	27	3	1027378	12	FRT90 S12.063ANS									
80	45	56	32	4	1027379	20	FRT90 S12.080ANS									

Verlängerungsdorne und Anschlußmaße siehe LMT-Katalog „Spannen“ ab Seite 221
Extension arbors and fitting dimensions refer LMT Catalogue “Chucking” starting page 221

Schnittwertempfehlungen ab Seite 172
Cutting data recommendations starting page 172

Besondere Merkmale:

- Unterschiedliche Fasenwinkel
- Auch für kleine Bohrungsdurchmesser
- Verwendung wirtschaftlicher Dreikant-Wendepplatten

Special features:

- Different setting angles
- Also for small bore sizes
- Using economical triangular inserts

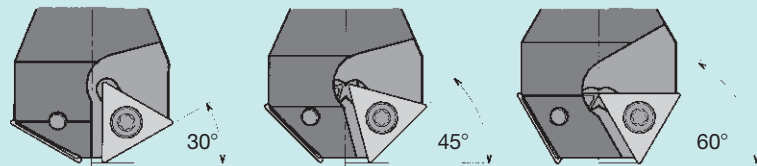

N = Anzahl der Schneidkanten N = Number of cutting edges	l	s	d	d ₁	b/r	ISO-Code	Schneidstoffsorten Cutting materials										Für Fräser For cutter Cat-No.			
							LC240T	LC230F	LC225T	LC225S	LW225	LC440T	LC444W	LC610E	LC610T	LC610T		LC610A	LW610	
<p>N = 3</p>	11	2,4	6,35	2,8	0,2	TCMT 110202				●	●					●				EFZ45T11 EFZ60T11
	16,5	3,97	9,52	4,3	0,4	TCMT 16T304				●	●						●			

Sortenbeschreibung/-bezeichnung und ISO-Code ab Seite 22
 Description/Designation of grades and ISO-Code starting page 22

EFZ 1148														
K	d ₁	d ₃	l ₁	l ₃	d ₂	z	Ident No.	LMT-Code		Ident No.	Ident No.			
30°	6	33	86	36	20	2	1043511	EFZ30 T16.033 BK	TCMT 16T304 1166-10	1045114	1048335			
45°	1,2	16	70	25	12	1	1043508	EFZ45 T11.016 BL	TCMT 110202 1166-00	1044972	1048326			
	6,2	21	80	32	16	2	1043517	EFZ45 T11.021 BK						
	10,4	32	86	36	20	2	1043509	EFZ45 T16.032 BL	TCMT 16T304 1166-10	1045114	1048335			
	10,4	32	95	39	25	2	1043526	EFZ45 T16.032 BM						
60°	5,4	16	70	25	12	1	1043562	EFZ60 T11.016 BL	TCMT 110202 1166-00	1044972	1048326			
	14,4	25	80	32	16	2	1043571	EFZ60 T11.025 BK						
	16	32	86	36	20	2	1043510	EFZ60 T16.032 BL	TCMT 16T304 1166-10	1045114	1048335			
	16	32	95	39	25	2	1043580	EFZ60 T16.032 BM						

Schnittwertempfehlungen ab Seite 172
 Cutting data recommendations starting page 172

Einsatzmöglichkeiten Possible applications

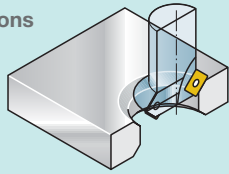

Bohrungen anfasen, zirkular
Beveling bores, circular

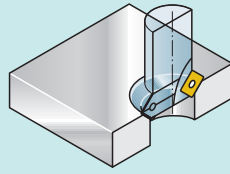

Bohrung 90° ansenken, axial
90° bore countersinking, axially

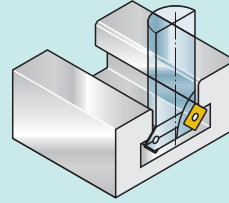

T- Nuten innen anfasen
Internal beveling of T-slots

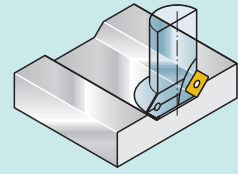

Profilmuten fräsen
Milling profiled slots

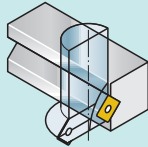

90° Prismen fräsen
90° vee form milling

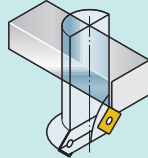

Rückwärts anfasen
Beveling backwards

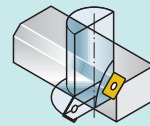

Stirnseitig anfasen
Beveling the end face

N = Anzahl der Schneidkanten N = Number of cutting edges	l	s	d	d ₁	b/r	ISO-Code	Schneidstoffsorten Cutting materials										Für Fräser For cutter Cat-No.		
							LC240T	LC230F	LC225T	LC225S	LW225	LC440T	LC444W	LC610E	LC610T	LC610T		LC610A	LW610
 N = 4	9,52	3,18	9,52	4		SDMT 090308			●	●									EFZ45 S09
 N = 4	9,52	3,18	9,52	4	0,8	SDMW 090308 ¹⁾	●	○	●	●									EFZ45 S09
 N = 4	12,7	4,76	12,7	5,2	0,8	SPMT 120408SN	●			●									EFZ45 S12
 N = 4	12,7	4,76	12,7	5,2	0,8	SPMT 120408SN-BP	●	○		●									EFZ45 S12
 N = 4	12,7	4,76	12,7	5,2	0,8	SPMW 120408 ¹⁾	●	●	●	●	●						●		EFZ45 S12

¹⁾ Andere Eckenradien auf Anfrage
¹⁾ Other corner radii on request

Sortenbeschreibung/-bezeichnung und ISO-Code ab Seite 22
Description/Designation of grades and ISO-Code starting page 22

EFZ45 11483

d ₁	a _p	d ₃	l ₁	l ₃	d ₂	z	Ident No.	LMT-Code		Ident No.	Ident No.
16	5	28,8	85	37	16	2	1043604	EFZ45 S09.016BN	SDMT 090308 1196-03 SPMT 120408 1196-12	1044981	1048335
20	7	37,3	95	45	20	2	1043606	EFZ45 S12.020BN			
25	7	42,3	110	54	25	2	1043608	EFZ45 S12.025BN			
32	7	49,3	125	65	32	3	1043610	EFZ45 S12.032BN			

EFZ45 11481

d ₁	d ₃	l ₁	l ₃	d ₂	z	Ident No.	LMT-Code		Ident No.	Ident No.
18	36	199	39	25	2	1043553	EFZ45 S12.018AV199	SPMT 120408 1196-12	1044963	1048344

Schnittwertempfehlungen ab Seite 172
Cutting data recommendations starting page 172

Besondere Merkmale:

- Für Guß- und Stahlbearbeitung
- Mit zentraler Kühlmittelzufuhr
- Für T-Nuten nach DIN 650 und eine
- Vielzahl von Nutenfräsoperationen

Special features:

- For machining steel and cast iron
- With internal coolant system
- For T-slots according to DIN 650 and
- multiple slotting operations

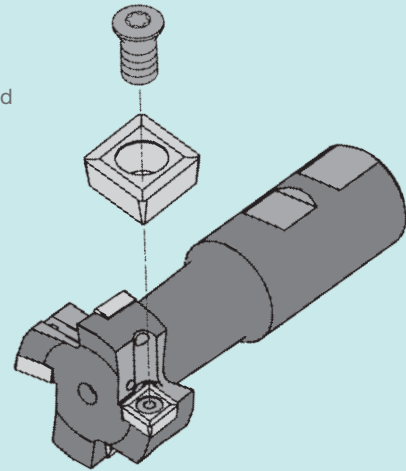

N = Anzahl der Schneidkanten N = Number of cutting edges							ISO-Code	Schneidstoffsorten Cutting materials										Für Fräser For cutter Cat-No.					
	l	s	d	d ₁	b/r			LC240T	LC230F	LC225T	LC225S	LW225	LC440T	LC444W	LC610E	LC610T	LC610T		LC610A	LW610			
<p>N = 2</p>	6,35	2,38	6,35	2,8	0,4	CCMT 060204	●		●	●	●					●					ESP90		
	7,94	3,18	7,94	3,4	0,8	CCMT 080308	●		●	●	●					●							
	9,52	3,97	9,52	4,4	0,8	CCMT 09T308			●	●	●												
	12,7	4,76	12,7	5,5	0,8	CCMT 120408			●	●	●												

Sortenbeschreibung/-bezeichnung und ISO-Code ab Seite 22
Description/Designation of grades and ISO-Code starting page 22

ESP90 11403-IK

d ₁	b ₁	T-Nuten T-slots	l ₃	l ₁	d ₃	d ₂	Ident No.	Stck. Pcs.	LMT-Code		Ident No.	Ident No.
25	11	14	34	82	12,5	16	1069001	4	ESP90 C06.025BE-I	CCMT 060204 1196-36	1044972	1048326
32	13	18	40	90	12,5	20	1069003	4	ESP90 C08.032BB-I	CCMT 080308 1196-46	2237513	
40	17	22	52	108	19,5	25	1069005	4	ESP90 C09.040BA-I	CCMT 09T308 1196-56	1045131	1048335
50	21	28	64	124	25	32	1069007	4	ESP90 C12.050BA-I	CCMT 120408 1196-66	1045766	

Zwischenabmessungen auf Anfrage
Other dimensions upon request

Schnittwertempfehlungen ab Seite 172
Cutting data recommendations starting page 172

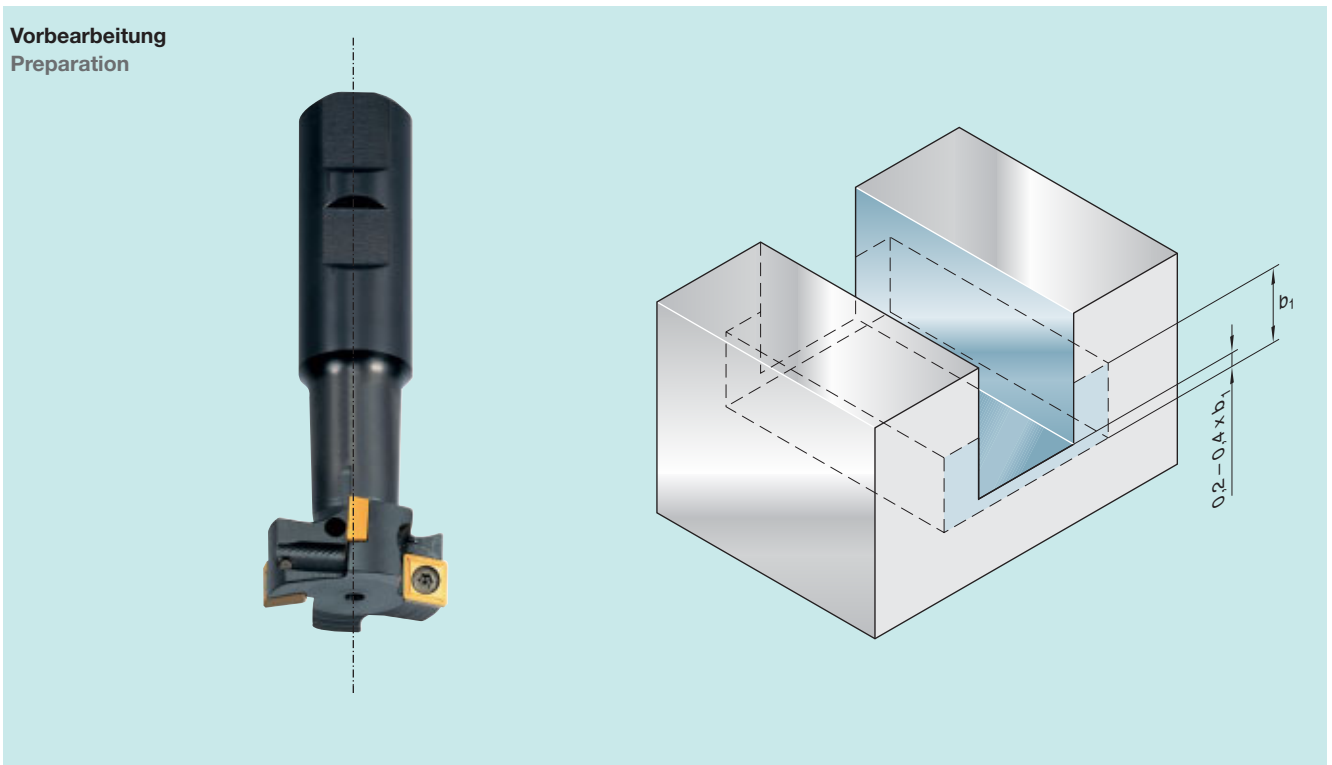

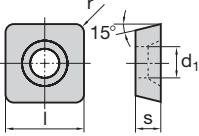
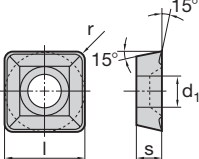
N = Anzahl der Schneidkanten N = Number of cutting edges						ISO-Code Cat-No.	Schneidstoffsorten Cutting materials Ident No.											Für Fräser For cutter Cat-No.					
	l	s	d	d ₁	b/r		LC240T	LC240S	LC230F	LC225T	LC225S	LC630T	LW240	LW225	LC440T	LC444W	LC610E		LC610T	LC610W	LC610A	LW610	LC603Z
 N = 4	16	5		5,2	1	SDHX 160510 1196-21		1069438			1069313		1069268	1069259							1069277		FRP90
 N = 4	16	5		5,3	1	SDMX 160510 1196-22		1069319					1069320								1069311		FRP90

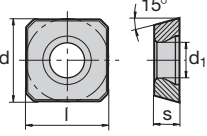
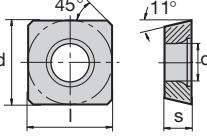
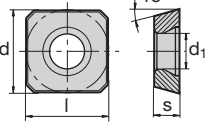
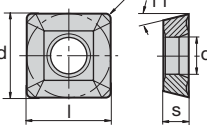
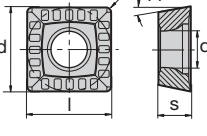
N = Anzahl der Schneidkanten N = Number of cutting edges						ISO-Code	Schneidstoffsorten Cutting materials										Für Fräser For cutter Cat-No.						
	l	s	d	d ₁	b/r		LC240T	LC230F	LC225T	LC225S	LW225	LC440T	LC444W	LC610E	LC610T	LC610T		LC610A	LW610				
 N = 4	9,52	3,18	9,52	4	0,8	SDMW 090308	●		○	●	●												
 N = 4	12,7	4,76	12,7	5,2	0,8	SPMW 120408	●	●	●	●	●				●								EFZ45
 N = 4	9,52	3,18	9,52	4	0,8	SDMW 090308	●		○	●	●												
 N = 4	12,7	4,76	12,7	5,2	0,8	SPMT 120408SN	●			●		●											EFZ45
 N = 4	12,7	4,76	12,7	5,2	0,8	SPMT 120408SN-BP	●		○	●													EFZ45

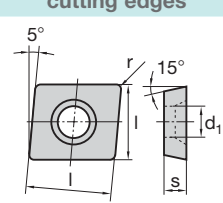
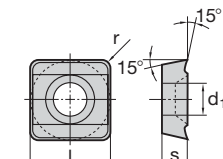
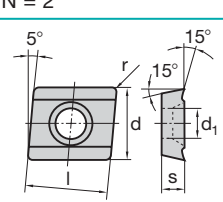
N = Anzahl der Schneidkanten N = Number of cutting edges							Schneidstoffsorten Cutting materials Ident No.											Für Fräser For cutter Cat-No.						
	l	s	d	d ₁	b/r	ISO-Code Cat-No.	LC240T	LC240S	LC230F	LC225T	LC225S	LC630T	LW240	LW225	LC440T	LC444W	LC610E		LC610T	LC610W	LC610A	LW610	LC603Z	
 N = 2	12,7	3,18	9,52	4	0,8	ADHW 120308 R 1196-02		1069440			1069153		1069151	1069142								1069133		FRP90
 N = 2	9,52	3,18		3,9	0,8	SDMW 090308 1196-05																1069204		FRP90
 N = 2	12,7	3,18	9,52	4	0,8	ADMT 120308 R 1196-04							1069197									1069188		

Sortenbeschreibung/-bezeichnung und ISO-Code ab Seite 22
Description/Designation of grades and ISO-Code starting page 22

Platten- größe Insert size		d ₁	l ₂	l ₁	d ₂	Anzugsschraube Arbor screw DIN 912	z	Ident No.	LMT-Code	Stck. Pcs.	Umfangspl. Peripheral ins.	Stck. Pcs.	Stirnplatte Face end ins.	Stck. Pcs.	Ident No.	Ident No.	
9,52	50	50	71	22	M 10 x 40	4	1035045	FRP90 S09.050AN	12	SDMW 090308 1196-01	2	ADHW 120308R 1196-02	14	1045114	1048335		
	63	36	50	27	M 12 x 30	6	1034992	FRP90 S09.063ANS	12							3	15
	63	56	71	27	M 12 x 45	6	1035090	FRP90 S09.063AN	21							3	24
12,7	80	44	56	32	M 16 x 30	6	1035009	FRP90 S12.080ANS	12	SPMW 120408 1196-10	3	SDHX 160510 1196-21	15	1044963	1048344		
	80	74	90	32	M 16 x 55	6	1035107	FRP90 S12.080AN	21							3	24
	100	55	63	40	M 20 x 30	6	1035018	FRP90 S12.100ANS	15							3	18
	100	83	100	40	M 20 x 60	6	1035116	FRP90 S12.100AN	24							3	27
	125	64	71	50	M 24 x 35	8	1035027	FRP90 S12.125ANS	24							4	28

Schnittwertempfehlungen ab Seite 172
Cutting data recommendations starting page 172

Besondere Merkmale:

- Wirtschaftliches Zirkularfräsen von Rechts- und Linksgewinden in Durchgangs- oder Sacklöchern
- Gratfreie Gewinde, hohe Oberflächengüte bis zum Bohrungsgrund
- Kurze Späne
- Hohe Schnittgeschwindigkeiten, kurze Fertigungszeit
- Geringer Leistungsbedarf

Special features:

- The need for only one tool or one indexable insert for different thread diameters with the same lead as well as right- or left hand thread in through- or blind holes
- Burr-free threads, high surface quality, down to the bottom of the bore
- Short chips
- High cutting speeds, short production time
- Modest power requirement

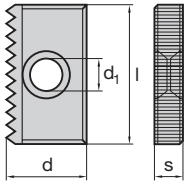
N = Anzahl der Schneidkanten N = Number of cutting edges	l	s	d	d ₁	b	r	Cat-No.	Norm/ Gewindeart Thread standard	Teilung/Steigung mm bzw Gg/1" Pitch lead mm resp. tpi	Schneidstoffsorte Cutting material	Für Fräser For cutter Cat-No.
										Ident No. LC225S ¹⁾	
 <p>N = 2 s = ± 0,01 l = ± 0,01</p>	25,4	5	14,3	5,5			1144-10	Metrisch ISO Innen	1	1041170	11440
									1,5	1041171	
	25,4	5	15,35	5,5				Metrisch ISO Internal	2	1041172	
									3	1041173	
									4	1041174	
	19,05	3,97	11,1	4,5			1144-12		1	1041175	
									1,5	1041176	
									2	1041177	
	14,3	3,30	11,1	4,5			1144-14		1	1041178	
									1,5	1041179	
									2	1041180	
	25,4	5	14,3	5,5			1144-30	Metrisch ISO Außen	1,5	1041181	
								Metrisch ISO External	2	1041182	
	25,4	5	14,3	5,5			1144-70	Whitworth-/	11	1041183	
	19,05	3,97	11,1	4,5			1144-72	Whitworth-	11	1041184	
	14,3	3,3	10	4,5			1144-74	Rohrgewinde Innen/Außen	14	1041185	
						+	BSW BSW BSP Internal/External				
25,4	5	14,3	5,5			1144-80	UN-Gewinde	16	1041186		
19,05	3,97	11	4,5			1144-82	ANSI B 1.1 Innen	20	1041187		
							ANSI B 1.1 Innen	16	1041188		
14,3	3,3	10	4,5			1144-84	ANSI B 1.1 Internal BS 1580	12	1041189		
								20	1041190		
								16	1041191		
								12	1041192		

¹⁾ Auch geeignet für das Gewindefräsen von Guß und NE-Metallen
¹⁾ Also useable for thread milling of cast iron and non-ferrous metals
 Wendeplatten für andere Gewindearten und/oder Steigungen auf Anfrage
 Indexable inserts for other thread types and/or leads on request

Andere Beschichtungen auf Anfrage
 Other coatings upon request

<p>ETZ90 11440-IK</p>												
d ₁	l ₂	l ₁	l ₃	d ₂ h ₆	z	Ident No.	LMT-Code		Ident No.	Ident No.		
16	14,3	80	30	16	1	1041023	ETZ90 X14.016BN-I	1144-14/-74/-84	1044981	1048335		
20	19,05	90	38	20	1	1041025	ETZ90 X19.020BN-I	1144-12/-72/-82	1045131			
25	19,05	110	42	25	2	1041027	ETZ90 X19.025BN-I					
28	25,4	112	52	25	1	1041031	ETZ90 X25.028BK-I	1144-10/-30/-70/-80/-90	1045766			
36	25,4	125	65	32	2	1041033	ETZ90 X25.036BJ-I					

Schnittwertempfehlungen ab Seite 172
Cutting data recommendations starting page 172

Hinweise
Directions

Außengewinde (Bolzen) rechtsgängig
External thread (bolt) right-hand

$A < L_2$

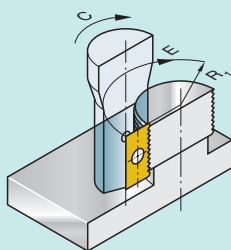
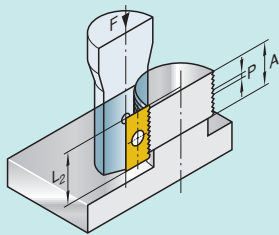

Innengewinde (Mutter) rechtsgängig
Internal thread (nut) right-hand

$A < L_2$

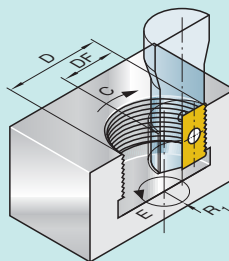
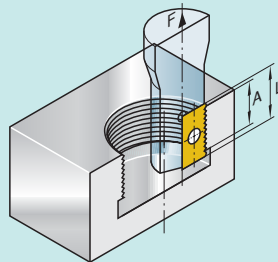

Axiales Versetzen um ein ganzzahliges
Vielfaches der Gewindesteigung P
Axial offset by a whole number of thread lead P

Gewindelänge A größer als Schneidenlänge L₂
Thread length A exceeds length of cut L₂

$A > L_2$

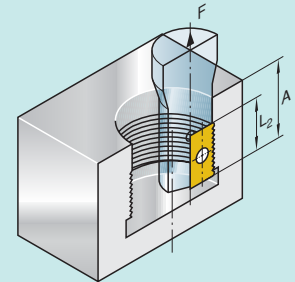

- D = Gewinde-Ø
Thread dia. Ø
- DF = Fräser-Ø
Cutter dia. Ø
- DF_{max} ≈ 0,7 x D
- P = Gewindesteigung
Thread lead
- A = Gewindelänge
Thread length
- L₂ = Schneidenlänge
Cutting length
- E = Fräsrichtung Gleichlauf
Direction of cut climb milling
- R₁ = Bahnradius Fräser
Track radius of milling cutter
- F = Axial-Vorschub P mm pro 360° Fräserumlauf
Axial feed P mm per 360° cutter revolution

Werkstoff	Material	R _m /UTS (N/mm ²)	HM-Sorte Carbide Grade	Schnittgeschwindigkeit Cutting speed v _c m/min	Leistungsfaktor Efficiency factor LF cm ³ /min · kW
Unlegierter Baustahl	Plain carbon steel	- 700	LC225S	180	24
Automatenstahl	Free cutting steel	- 700	LC225S	180	22
Baustahl	Structural alloy steel	500 - 950	LC225S	150	20
Vergütungsstahl, mittelfest	Heat-treatable steel, medium strength	500 - 950	LC225S	130	18
Stahlguss	Cast steel	- 950	LC225S	130	18
Einsatzstahl	Case hardening steel	- 950	LC225S	130	18
Rost- und säurebeständiger Stahl, ferritisch, martensitisch	Stainless steel, ferritic, martensitic	500 - 950	LC225S	140	16
Vergütungsstahl, hochfest	Heat-treatable steel, high strength	950 - 1400	LC240T	120	16
Nitrierstahl, vergütet	Nitriding steel	950 - 1400	LC240T	120	16
Werkzeugstahl	Tool steel	950 - 1400	LC240T	120	14
Rost- und säurebeständiger Stahl, austenitisch	Stainless steel, austenitic	500 - 950	LC225S	240 60 ³⁾	18
Martensitaushärtbarer Stahl	Maraging steel				
Grauguss	Grey cast iron	100 - 400 (120 - 260 HB)	LC610T ²⁾	160	30
Legierter Grauguss	Alloyed grey cast iron	150 - 250 (160 - 230 HB)	LC610T ²⁾	110	22
Sphäroguss	Nodular cast iron	400 - 800 (120 - 310 HB)	LC610T ²⁾	90	24
Temperguss	Malleable cast iron	350 - 700 (150 - 280 HB)	LC610T ²⁾	100	24
Rein-Metalle, weich	Pure metals, soft	- 500	LC225S	200	50
Aluminium-Legierungen, langspanend	Aluminium alloys, long chipping	- 550	LW610 ¹⁾	1000	60
Aluminium-Legierungen, kurzspanend	Aluminium alloys, short chipping	- 400	LW610 ¹⁾	300	55
Kupfer-Legierungen, langspanend	Copper alloys, long chipping	300 - 700	LC225S	250	50
Kupfer-Legierungen, kurzspanend	Copper alloys, short chipping	- 500	LC225S	250	35
Magnesium-Legierungen	Magnesium alloys	160 - 300	LW610 ¹⁾	400	50
Thermoplaste	Thermoplastics	40 - 70	LW610 ¹⁾	250	70
Duroplaste	Duroplastics	20 - 40	LW610 ¹⁾	200 ¹⁾	35
Graphit	Graphite				
Titan-Legierungen, mittelfest	Titanium alloys, medium strength	- 950	LW610 ¹⁾	70	20
Titan-Legierungen, hochfest	Titanium alloys, high strength	900 - 1400	LW610 ¹⁾	40	16
Nickelbasis-Legierungen, mittelfest	Nickel based alloys, medium strength	- 950	LC225S	40	18
Nickel-Basis-Legierungen, hochwarmfest	Heat resistant nickel based alloys, high strength	900 - 1400	LC240T	30	15
Hartguss	Chilled cast iron	300 - 600 HB	LC240T	40	24

¹⁾ Unbeschichtete HM-Sorte, v_c-Wert der Tabelle ist gültig für diese Sorte

¹⁾ Uncoated grade, value of v_c is valid for this grade

²⁾ Alternativ LW610 (unbeschichtet) verwenden, dann v_c-Wert um 30 % reduzieren

²⁾ Use alternatively LW610 (uncoated) and reduce v_c by 30 %

³⁾ Bei Verwendung von Kühlschmierstoffen

³⁾ When using liquid coolants

Beim Einsatz unbeschichteter Sorten Schnittgeschwindigkeit um 30 % reduzieren.

When using uncoated grades reduce cutting speed by 30 %.

Technische Hinweise Technical hints

Zahnvorschübe f_z (mm) bei $a_e \approx 0,5 \cdot d_1$
Feed rates f_z (mm) bei $a_e \approx 0,5 \cdot d_1$

Cat.-No.	ERT90 11257 11256 FRT90 11259	FRP90 1133	ERU90 11552 11555 FRU90 11335	EMH90 11412	EMU90 11473-IK 11472 11474-IK	ESP90 11470	ESP90 11403-IK	ETZ90 11440-IK	EFZ 1148	EFZ45 11483 11481 11485
Ø	50 - 80	50 - 125	25 - 63	12 - 40	25 - 40	11,7 - 31,7	25 - 50	16 - 36	16 - 32	28 - 36
ISO-Code	SNKX	SPMW	ADMX	APKT	ADHX	CCHX	CCMT	-	TCMT	SPMW
	0,20 - 0,25	0,15 - 0,20	0,12 - 0,15	0,20 - 0,25	0,12 - 0,15	0,10 - 0,15	0,10 - 0,15	0,15 - 0,20	0,15 - 0,20	0,10 - 0,20
	-	-	0,1	-	0,1	-	-	0,1	0,10	0,10
	0,25	0,20	0,20	0,20	0,20	0,15	0,15	0,15	0,25	0,25
	0,30	0,25	0,25	0,25	0,25	0,20	0,20	0,20	0,30	0,30
	-	-	0,10	-	0,10	-	-	0,10	0,10	0,10

ETZ90 FRP90					
$a_e =$	$0,1 \cdot d_1$	$0,25 \cdot d_1$	$0,5 \cdot d_1$	$0,75 \cdot d_1$	$1 \cdot d_1$
f_2 -Multiplikator	1,6	1,4	1	0,8	0,7
f_2 -Multiplicator					

gilt nicht für not valid for 11257, 11258, 11259

ESP90	Tauchfräsen mit Univex Plunge milling using Univex EMU90, FMU90, ERU90, FRU90			
Bohrnutenfräser $z = 1$ Slot Drills $z = 1$	Schrägungswinkel W_1 , max beim Tauchfräsen (Ramping) Bevel angle W_1 , max. for plunge milling "ramping"			
Bohren ins Volle Drilling with full engagement $f_2 = 0,5$			d_1	l_2
			d	W_1 max Grad Degree
			12	4,5
			14	3,3
			16	2,6
			18	2,2
			20	1,9
			22	1,6
			25	1,9
			28	1,6
			30	1,4
			32	1,3
			36	1,1
			40	1,0

Formeln Formulas

Drehzahl Speed n (min⁻¹):

$$n = \frac{v_c \cdot 1000}{\pi \cdot d_1}$$

Schnittgeschwindigkeit Cutting speed

$$v_c \text{ (m/min): } v_c = \frac{n \cdot \pi \cdot d_1}{1000}$$

v_c = Schnittgeschwindigkeit Cutting speed (m/min)

n = Drehzahl (min⁻¹) Speed (min⁻¹)

d_1 = Fräser-Durchmesser (mm) Cutter dia. (mm)

v_f = Vorschubgeschwindigkeit Feed rate (mm/min)

f_z = Vorschub pro Zahn Feed per tooth (mm)

P_e = Antriebsleistung Drive power

z_{eff} = effektive Zähnezahl Effective number of teeth

f_2 = Korrekturfaktor für v_f Correction factor

Q = Spanvolumen Chip volume (cm³/min)

a_e = Schnittbreite Width of cut (mm)

a_p = Schnitttiefe Depth of cut (mm)

LF = Leistungsfaktor Efficiency factor (cm³/min/kW)

Vorschubgeschwindigkeit Feed rate

v_f (mm/min):

$$v_f = f_z \cdot z_{eff} \cdot n \cdot f_2$$

Vorschub pro Zahn Feed per tooth

f_z (mm):

$$f_z = \frac{v_f}{z_{eff} \cdot n \cdot f_2}$$

Spanvolumen Chip volume Q (cm³/min):

$$Q = \frac{a_e \cdot a_p \cdot v_f}{1000}$$

Antriebsleistung Drive power

$$P_e \text{ (kW): } P_e = \frac{Q}{LF}$$

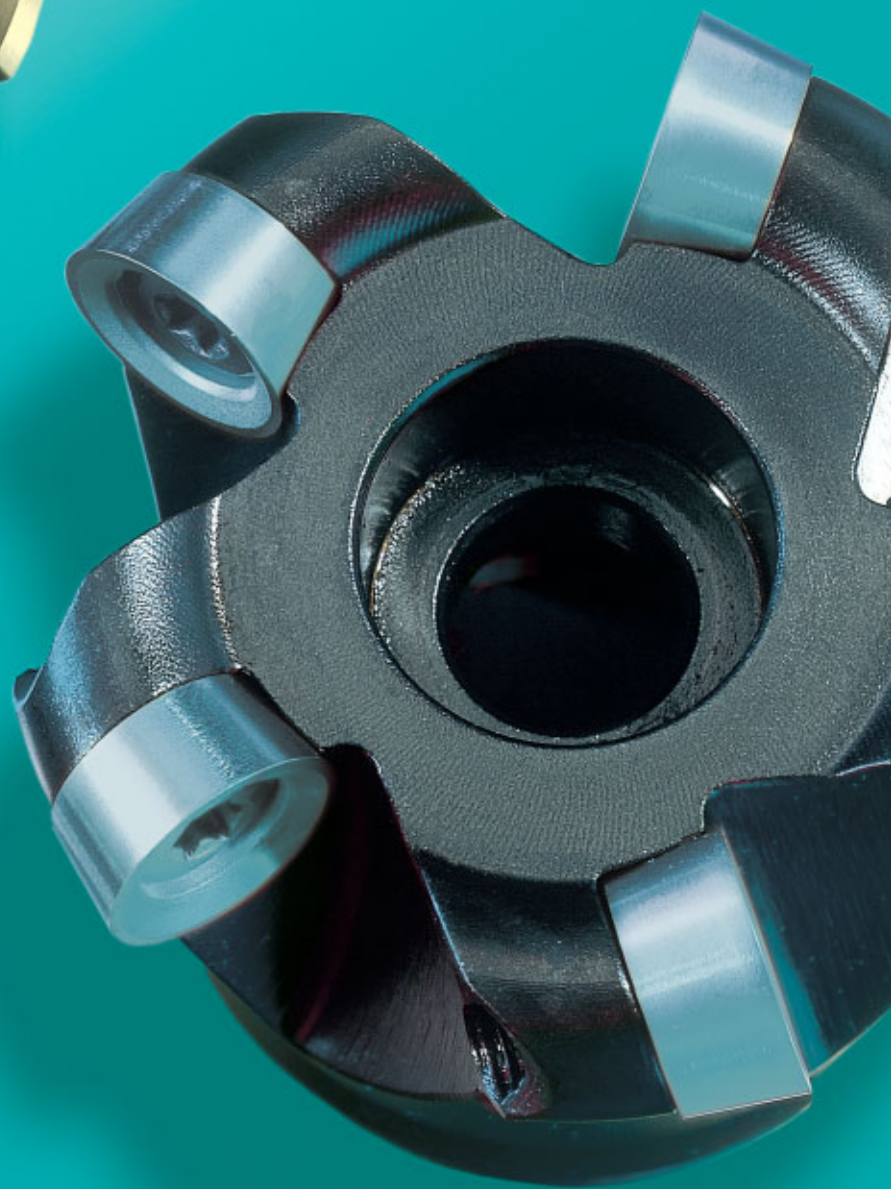
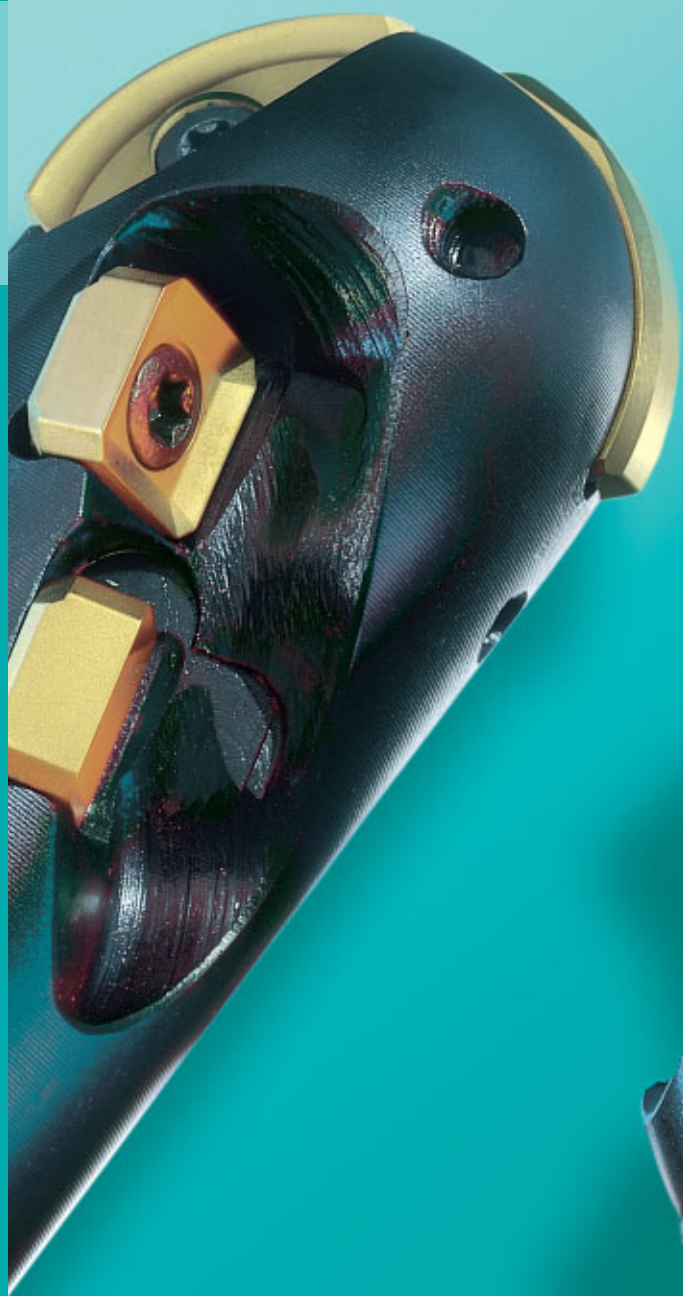

Kopierfräser

Copying Cutters

Auswahlübersicht Selection table	176
Kopierfräser Copy Milling Cutters	178
Kugelpkopier-Schruppfräser Ball Nose Copying Roughing End Mills	190
Kugelpkopier-Schlichtfräser Ball Nose Copying Finishing End Mills	210
Schnittwertempfehlungen Cutting data recommendations	220, 222, 223

Auswahlübersicht Selection table

Kopierfräser Copying Cutters

	Cat.-No.			Nenn-Ø Nominal-Ø	Seite Page
	ECP 05	Hochvorschubfräser zum Schruppen Highfeed Cutters for roughing		20 – 42	179
	FCP 05			42 – 66	179
	EMZ 90	Wendeplattenfräser für NE-Metalle und Kunststoffe Cutters with Inserts for non ferrous metals and plastics	VPCT 	20 – 42	181
	FMZ 90			42 – 125	181
	FCT 11355	Kopierfräser mit Twincut-Geometrie Copy Milling Cutters with Twincut geometry d ₄ = 5–8–10–12–16 mm	RCHX 	42 – 125	183
	ECT 11467				
	FCZ 11350	Kopierfräser für Rundwendeplatten Copy Milling Cutters for Round Inserts d ₄ = 5–7–8–10–12–16 mm	RDHW RDHX 	52 – 80	187
	ECZ 11460			12 – 40	189
	ECZ 11465			8 – 40	185
	EBT 11493	Kugel-Kopier- schruppfräser mit Twincut-Geometrie Ball Nose Copying Roughing End Mills with Twincut geometry		20 – 40	193
	EBT 11490			20 – 50	193
	EBT 11497			20 – 50	191

FCT 45 und FCT XX siehe Abschnitt Plan- und Eckfräsköpfe
FCT 45 and FCT XX see section Face milling cutters

Auswahlübersicht Selection table

Kopierfräser Copying Cutters

	Cat.-No.			Nenn-Ø Nominal-Ø	Seite Page
	EBG T (GRT)	Kugel-Kopier-schrupp- fräser Ball Nose Copying Roughing End Mills z = 2		25 – 32	194
	EBT 11432	Kugel-Kopierfräser mit Twincut-Geometrie Ball Nose Finishing End Mills with Twincut geometry		16 – 32	197
	EBT 11434			16 – 25	197
	EBG R (GWR)	Kugel-Kopierfräser Ball Nose Finishing End Mills z = 2	Vollprofil Full depth profile 	6 – 32	200
	EBG R (GWR MK)			12 – 32	202
	EBG R THR (GWR THR)			8 – 25	205
	EBG V (GWV)	Schaft-Schlichtfräser Finishing End Mills z = 2	Vollprofil Full depth profile 	18 – 32	210
	EBG V (GWV MK)			12 – 32	212
	EBG V THR (GWV THR)	Kopierfräser Copying Cutters z = 2	Vollprofil Full depth profile 	12 – 32	214

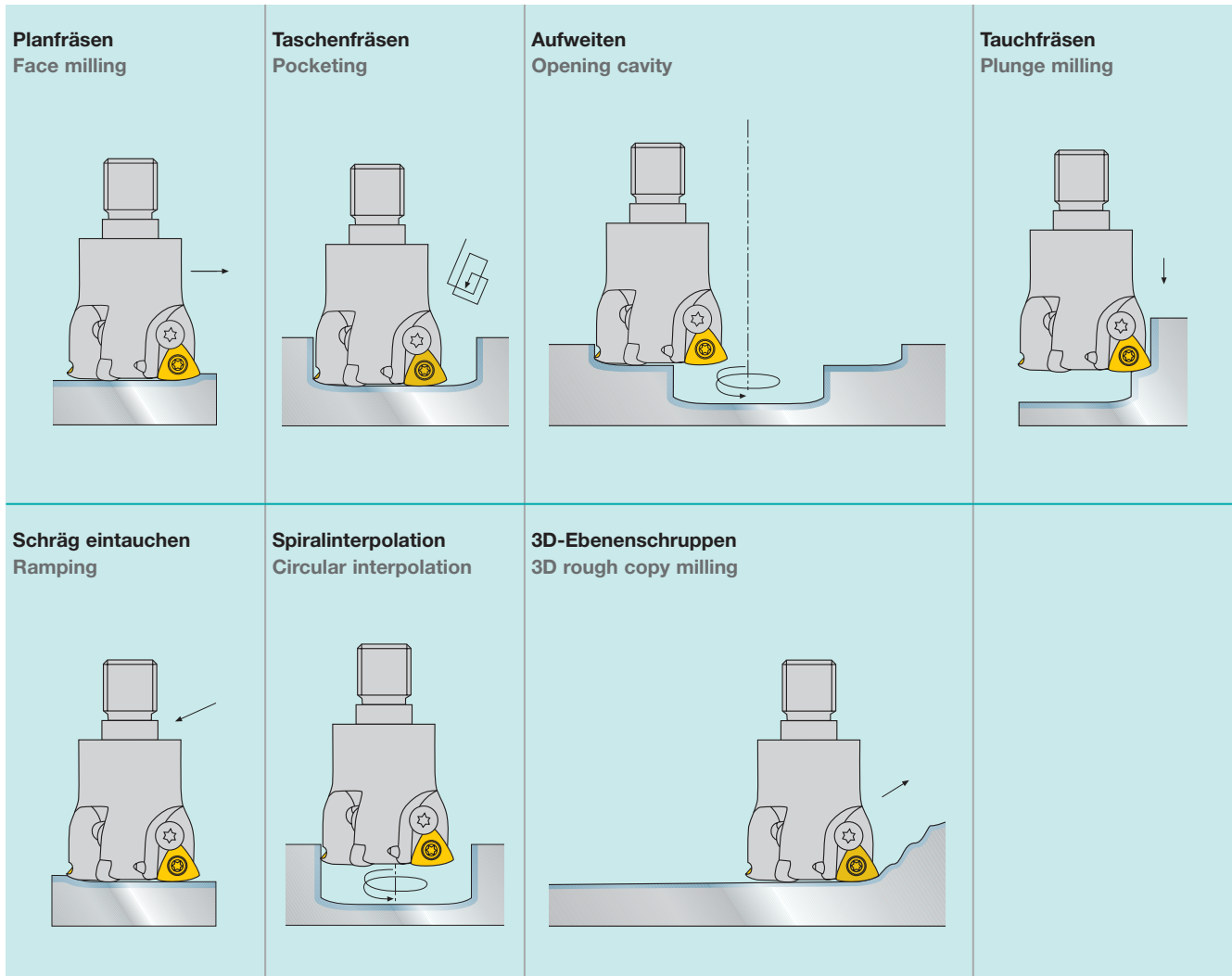

N = Anzahl der Schneidkanten N = Number of cutting edges						ISO-Code Cat-No.	Schneidstoffsorten Cutting materials Ident No.										Für Fräser For cutter Cat-No.						
	l	s	d	d ₁	b/r		LC240T	LC240S	LC230F	LC225T	LC225S	LC630T	LW240	LW225	LC440T	LC444W		LC610E	LC610T	LC610W	LC610A	LW610	LC603Z
<p>N = 3 s = ± 0,02 d = ± 0,01</p>		2,78	9,52	3,9	6	1177-11T	1058190 ¹⁾										1058191						ECP05
<p>N = 3 s = ± 0,025 d = ± 0,01</p>		3,97	9,52	3,9	25	1177-65T	1058187 ¹⁾										1058187						ECP05 FCP05

¹⁾ LC280TT Schruppgeometrie mit 2-fach Beschichtung
Roughing geometry with double coating

Sortenbeschreibung/-bezeichnung und ISO-Code ab Seite 22
Description/Designation of grades and ISO-Code starting page 22

Twincut Feed ECP 05 THR IK															
d ₁	d _i	l ₃	d ₃	d ₂	l ₁	R _{theo}	z	Ident No.	LMT-Code		Ident No.	Ident No.	Ident No.		
20	9,8	30	M10	10,5	3	3,8	2	1025011	ECP05 X11.020TS030-I	1177-11T	1051277	1045185	1048335		
25	14,8	33	M12	12,5	3	3,8	2	1025012	ECP05 X11.025TF033-I						
32	15,4	43	M16	17	1,5	2	2	1025013	ECP05 X65.032TH043-I	1177-65T	1045114	1045185	1048335		
35	18,4	43	M16	17	1,5	2	2	1025008	ECP05 X65.035TH043-I						
42	25,4	43	M16	17	1,5	2	3	1025009	ECP05 X65.042TH043-I						

Twincut Feed FCP 05 IK															
d ₁	d _i	l ₂	d ₂	l ₁	R _{theo}	z	Ident No.	LMT-Code		Ident No.	Ident No.	Ident No.			
42	25,4	40	16	1,5	2	3	1025002	FCP05 X65.032AN-I	1177-65T	1045114	1045185	1048335			
52	35,4	40	16	1,5	2	4	1025003	FCP05 X65.052AN-I							
66	49,4	50	22	1,5	2	5	1025004	FCP05 X65.066AN-I							



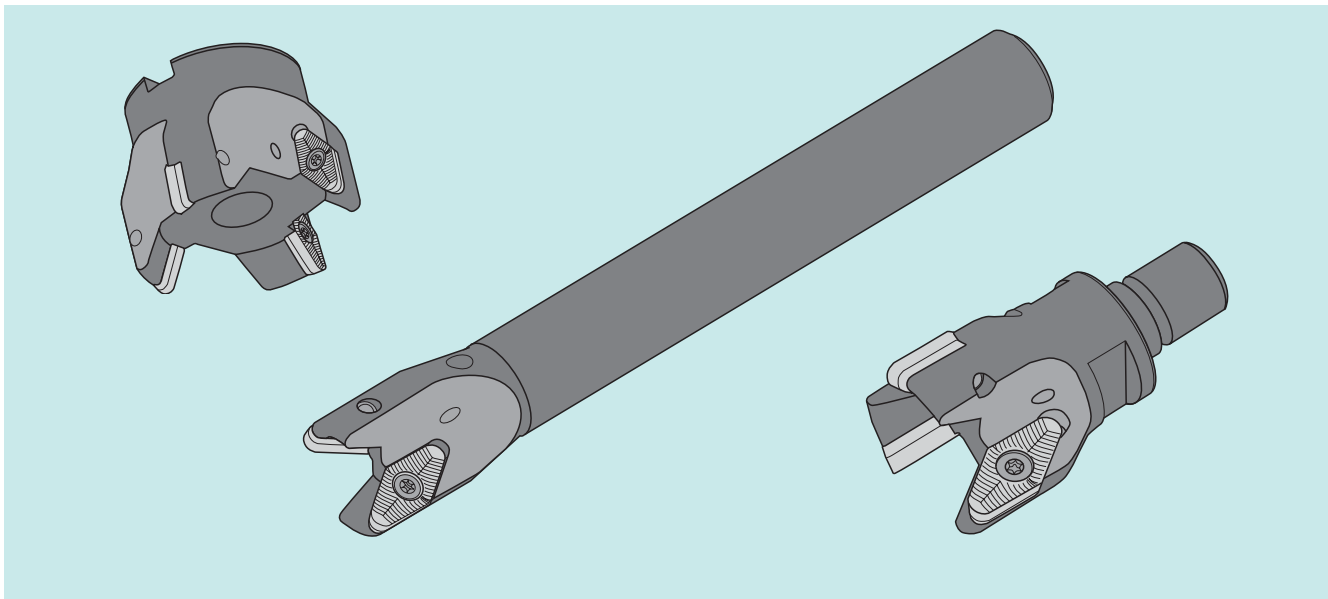

IK = Innere Kühlmittelzufuhr
 IK = Internal coolant supply



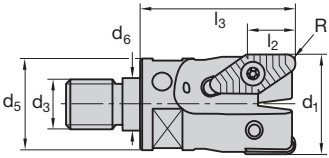
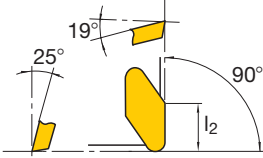

Schnittwertempfehlungen ab Seite 223
 Cutting data recommendations starting page 223





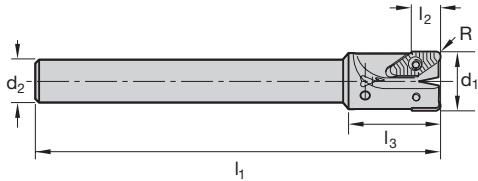
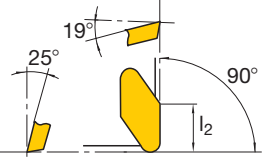

N = Anzahl der Schneidkanten N = Number of cutting edges							ISO-Code Cat-No.	Schneidstoffsorten Cutting materials Ident No.											Für Fräser For cutter Cat-No.						
	l	s	d	d ₁	b/r			LC240T	LC240S	LC230F	LC225T	LC225S	LC630T	LW240	LW225	LC440T	LC444W	LC610E		LC610T	LC610W	LC610A	LW610	LC603Z	
<p>7° bei VC_ 15° bei VP_</p>	11,61	3,18	6,35	2,8	0,4	VPGT110304-ALM																		EMZ90 FMZ90	
	16,6	4,76	9,52	4,4	1,2	VPGT160412-ALM												1069756					1069755		
	22,1	5,56	12,7	5,5	3	VCGT220530-ALM												1069758	1069758				1069757		
<p>35°</p>																		1069760				1069759			

Sortenbeschreibung/-bezeichnung und ISO-Code ab Seite 22
Description/Designation of grades and ISO-Code starting page 22

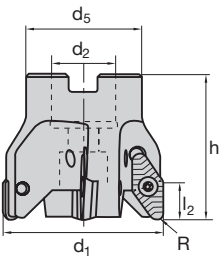
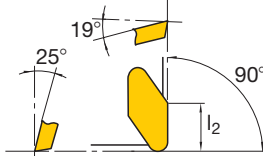
EMZ 90 THR IK										  		  	
d ₁	R	l ₃	l ₂	d ₅	d ₃	d ₂ h6	z	Ident No.	LMT-Code	Wendeplatte Insert	Ident No.	Ident No.	
20	0,4	30	10	18	M10	10,5	2	1043246	EMZ90 V11.020TS030-I	VPGT 110304-ALM	1044972	1048326	
25	1,2	40	13,5	21	M12	12,5	2	1043247	EMZ90 V16.025TF040-I	VPGT 160412-ALM	1051312	1048335	
32	3	50	15	29	M16	17	2	1043248	EMZ90 V22.032TH050-I	VCGT 220530-ALM	1045766		
42	3	50	15	29	M16	17	3	1043249	EMZ90 V22.042TH050-I				

EMZ 90 IK										  		  	
d ₁	R	l ₃	l ₂	h	d ₂	z	Ident No.	LMT-Code	Wendeplatte Insert	Ident No.	Ident No.		
20	0,4	30	10	175	16	2	1043242	EMZ90 V11.020AJ-I	VPGT110304-ALM	1044972	1048326		
25	1,2	40	13,5	200	20	2	1043243	EMZ90 V16.025AI-I	VPGT160412-ALM	1051312	1048335		
32	3	50	15	220	25	2	1043244	EMZ90 V22.032AG-I	VCGT 220530-ALM	1045766			
42	3	50	15	220	25	3	1043245	EMZ90 V22.042AA-I					



FMZ 90 IK										  		  	
d ₁	R	l ₂	h	d ₂	z	Ident No.	LMT-Code	Wendeplatte Insert	Ident No.	Ident No.			
42	3	15	55	16	3	1043253	FMZ90 V22.042AN-I	VCGT 220530-ALM	1045766	1048335			
52	3	15	55	22	3	1043254	FMZ90 V22.052AN-I						
66	3	15	60	27	4	1043255	FMZ90 V22.066AN-I						
80	3	15	60	27	4	1043256	FMZ90 V22.080AN-I						
100	3	15	65	32	5	1043257	FMZ90 V22.100AN-I						
125	3	15	65	32	6	1043258	FMZ90 V22.125AN-I						

IK = Innere Kühlmittelzufuhr
IK = Internal coolant supply

Schnittwertempfehlungen ab Seite 222
Cutting data recommendations starting page 222

N = Anzahl der Schneidkanten N = Number of cutting edges						Schneidstoffsorten Cutting materials Ident No.											Für Fräser For cutter Cat-No.									
	l	s	d	d ₁	b/r	ISO-Code Cat-No.	LC240T	LC240S	LC230F	LC225T	LC225S	LC630T	LW240	LW225	LC440T	LC444W		LC610E	LC610T	LC610W	LC610A	LW610	LC603Z			
	1,98	5	2,1			RCHX 05T1 MO 1195-02	1055635																	ECT		
	2,78	7	2,8			RCHX 0702 MO 1195-07	1068443																			
	3,18	8	3,4			RCHX 0803 MO 1195-03	1068387	1068378																		
	3,97	10	4,4			RCHX 10T3 MO 1195-04	1068393	1068388																	ECT FCT	
	5,56	12	5,2			RCHX 1205 MO 1195-13	1068375	1068406												1068377						
	6,35	16	5,8			RCHX 1606 MO 1195-14	1068379	1068415																		ECT FCT MCT
	5,56	12	5,2			RCHX 1205 MO-TR 1195-13 TR	1069519	1069517																	ECT FCT	
	6,35	12	5,2			RCHX 1606 MO-TR 1195-14 TR	1069506	1069501																		ECT FCT MCT
<p>breite Schneidkantenfase wide land</p>	3,18	8	3,4			RCHX 0803 MO-T 1195-03 T																			ECT	
	3,97	10	4,4			RCHX 10T3 MO-T 1195-04 T																			ECT FCT	
	5,56	12	5,2			RCHX 1205 MO-T 1195-13 T																				
	5,56	16	5,8			RCHX 1205 MO-T 1195-23	1068395	1068409																		
	6,35	16	5,8			RCHX 1606 MO-T 1195-24	1068389	1068417																		ECT FCT MCT
	5,56	12	5,2			RCMX 1205 MO-T 1195-27	1068425																		ECT FCT	
	6,35	16	5,8			RCMX 1606 MO-T 1195-28	1068429																		ECT FCT MCT	
	3,18	8	3,4			RCKT 0803 MO-TT	1055735 ¹⁾																		ECT	
	3,97	10	4,4			RCKT 10T3 MO-TT	1055734 ¹⁾																		ECT FCT	
	5,56	12	5,2			RCKT 1205 MO-TT	1055733 ¹⁾																		ECT FCT	
	6,35	16	5,8			RCKT 1606 MO-TT	1055732 ¹⁾																		ECT FCT MCT	

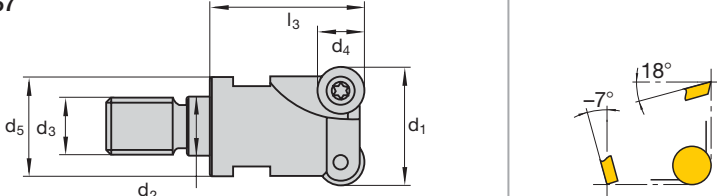
¹⁾ LC280TT Schruppgeometrie mit 2-fach Beschichtung
 Roughing geometry with double coating

ECT THR 11467												
d ₁	d ₄	l ₃	d ₅	d ₃	d ₂	z	Ident No.	LMT-Code	Wendeplatte Insert	Ident No.	Ident No.	
10	5	28	13	M 8	8,5	2	1040995	ECT R05.010TR028	RCHX05T1MO	1045604	1048434 T6	
12	5	28	13	M 8	8,5	2	1040996	ECT R05.012TR028				
16	5	25	13	M 8	8,5	4	1041091	ECT R05.016TR028				
20	5	26	18	M10	10,5	5	1041092	ECT R05.020TS026				
25	5	33	18	M10	10,5	6	1041093	ECT R05.025TS033				
32	5	43	29 (26)	M16	17,0	7	1041094	ECT R05.032TH043				
15	7	23	13	M 8	8,5	2	1041101	ECT R07.015TR023	RCHX0702MO	1044972	104832 T8	
20	7	30	18	M10	10,5	4	1041103	ECT R07.030TS030	RCHX0803MO	2237513	1048326 T8	
16	8	25	13	M 8	8,5	2	1041042	ECT R08.016TR025				
20	8	26	18	M10	10,5	3	1041095	ECT R08.020TS026	RCHX10T3MO	1045132	1048335 T15	
25	8	33	18	M10	10,5	4	1041096	ECT R08.025TS033				
20	10	26	18	M10	10,5	2	1041045	ECT R10.020TS026				
25	10	33	18	M10	10,5	3	1041046	ECT R10.025TS033	RCHX1205MO	1045123	1048344 T20	
30	10	43	29	M16	17,0	4	1041097	ECT R10.030TH043				
35	10	43	29	M16	17,0	4	1041098	ECT R10.035TH043				
25	12	33	21	M12	12,5	2	1041074	ECT R12.025TF033	RCHX1205MO	1045123	1048344 T20	
32	12	43	29	M16	17,0	3	1041062	ECT R12.032TH043				
40	12	43	29	M16	17,0	4	1041064	ECT R12.040TH043	RCHX1606MO	1045777		
32	16	43	29	M16	17,0	2	1041105	ECT R16.032TH043				

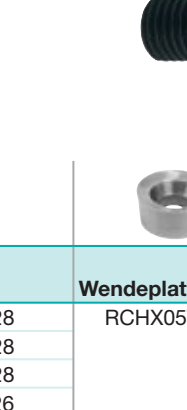
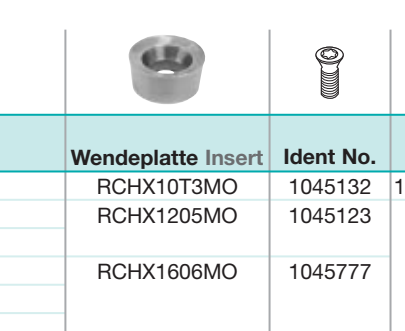
FCT 11355										
d ₁	d ₄	h	d ₂	z	Ident No.	LMT-Code	Wendeplatte Insert	Ident No.	Ident No.	
42	10	40	16	5	1041087	FCT R10.042AN	RCHX10T3MO	1045132	1048335 T15	
52	12	40	22	5	1041051	FCT R12.052AN	RCHX1205MO	1045123	1045344 T20	
66	12	50	27	6	1041055	FCT R12.066AN	RCHX1606MO	1045777		
66	16	50	27	5	1041058	FCT R16.066AN				
80	16	50	27	6	1041060	FCT R16.080AN				
100	16	50	32	7	1041073	FCT R16.100AN				
125	16	63	40	8	1041075	FCT R16.125AN				

Schnittwertempfehlungen ab Seite 220
Cutting data recommendations starting page 220

N = Anzahl der Schneidkanten N = Number of cutting edges						ISO-Code Cat-No.	Schneidstoffsorten Cutting materials Ident No.										Für Fräser For cutter Cat-No.						
	l	s	d	d ₁	b/r		LC240T	LC240S	LC230F	LC225T	LC225S	LC630T	LW240	LW225	LC440T	LC444W		LC610E	LC610T	LC610W	LC610A	LW610	LC603Z
	1,5	5	2			RDHX 0501 MO 1195-01	1055505	1068869															ECZ
	2,38	7	2,7			RDHX 0702 MO 1195-09	1055617	1055616															
	2,38	8	2,8			RDHW 0802 MO 1195-15	1068612	1070129															ECZ
	3,18	10	3,8			RDHW 1003 MO 1195-25	1068613	1070137															
	3,97	12	5			RDHW 12T3 MO 1195-35	1068614	1070147															ECZ FCZ
	3,97	12	3,8			RDHX 12T3 MO 1195-36	1070156	1070156															
	4,76	16	5,2			RDHW 1604 MO 1195-45	1070167	1070167															
	2,38	7	2,7			RDKT 0702 MO-TT	1055741 ¹⁾																ECZ
	2,38	8	2,8			RDKT 0802 MO-TT	1055740 ¹⁾																
	3,18	10	3,8			RDKT 1003 MO-TT	1055739 ¹⁾																
	3,18	10	3,8			RDKT 1003 MO						1070170						1070173			1070172		
	3,97	12	5			RDKT 12T3 MO-TT	1055737 ¹⁾																ECZ FCZ
	3,97	12	3,8			RDKX 12T3 MO-TT	1055738 ¹⁾																
	3,97	12	3,8			RDKX 12T3 MO						1070176						1070179			1070178		
	4,76	16	5,2			RDKT 1604 MO-TT	1055736 ¹⁾																
	4,76	16	5,2			RDKT 1604 MO						1070180						1070183			1070182		

¹⁾ LC280TT Schruppgeometrie mit 2-fach Beschichtung
Roughing geometry with double coating

Sortenbeschreibung/-bezeichnung und ISO-Code ab Seite 22
Description/Designation of grades and ISO-Code starting page 22







ECZ THR 11465												
d ₁	d ₄	l ₃	d ₅	d ₃	d ₂	z	Ident No.	LMT-Code	Wendeplatte Insert	Ident No.	Ident No.	
8	5	28	9,7	M 6	6,5	1	2309120	ECZ R05.008TC028	RDHX0501MO	1045604	1048343 T6	
10	5	18	9,7	M 6	6,5	2	1043211	ECZ R05.010TC018				
12	5	28	13	M 8	8,5	3	1041109	ECZ R05.012TR028				
16	5	28	13	M 8	8,5	4	2309126	ECZ R07.016TR028				
20	5	30	18	M10	10,5	5	1043201	ECZ R05.020TS030				
12	7	18	9,7	M 6	6,5	2	1043212	ECZ R07.012TC018	RDHX0702MO	1045972	1048326 T8	
12	7	28	13	M 8	8,5	2	1043219	ECZ R07.012TR028				
15	7	28	13	M 8	8,5	2	1040997	ECZ R07.015TR028				
15	7	23	13	M 8	8,5	3	1043194	ECZ R07.015TR023-F				
20	7	30	18	M10	10,5	4	1043200	ECZ R07.020TS030				
25	7	35	21	M12	12,5	5	1043207	ECZ R07.025TF035	RDHW0802MO	1044972	1048326 T8	
30	7	43	26	M16	17,0	5	1043213	ECZ R07.030TH043				
35	7	43	26	M16	17,0	6	1043215	ECZ R07.036TH043				
16	8	28	13	M 8	8,5	2	1043220	ECZ R08.016TR028				
20	8	29	16	M10	10,5	2	1043221	ECZ R08.020TS029				
20	10	30	18	M10	10,5	2	1043202	ECZ R10.020TS030	RDHW1003MO	1044981	1048335 T15	
25	10	35	21	M12	12,5	2	1043193	ECZ R10.025TF055				
25	10	35	21	M12	12,5	3	1043206	ECZ R10.025TF035				
30	10	43	29	M16	17,0	4	1043208	ECZ R10.030TH043				
35	10	43	29	M16	17,0	4	1043209	ECZ R10.035TH043				
42	10	43	29	M16	17,0	5	1043222	ECZ R10.042TH043	RDHW12T3MO	1045123	1048344 T20	
24	12	35	21	M12	12,5	2	1043204	ECZ R12.024TF035				
32	12	43	29	M16	17,0	3	1043195	ECZ R12.032TH066				
35	12	43	29	M16	17,0	3	1043216	ECZ R12.035TH043				
40	12	43	29	M16	17,0	4	1043197	ECZ R12.040TH070				
24	12	35	21	M12	12,5	2	1043224	ECZ R12.024TF035-B	RDHX12T3MO	1045105	1048335 T15	
35	12	43	29	M16	17,0	3	1043225	ECZ R12.035TH043-B				
42	12	43	29	M16	17,0	4	1043226	ECZ R12.042TH043-B				
32	16	43	29	M16	17,0	2	1043210	ECZ R16.032TH043	RDHW1604MO	1044990	1048344 T20	

Schnittwertempfehlungen ab Seite 220
Cutting data recommendations starting page 220

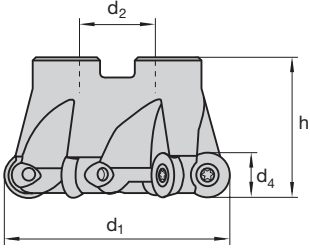
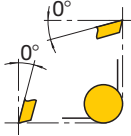
N = Anzahl der Schneidkanten N = Number of cutting edges						ISO-Code Cat-No.	Ident No.											Für Fräser For cutter Cat-No.					
	l	s	d	d ₁	b/r		LC240T	LC240S	LC230F	LC225T	LC225S	LC630T	LW240	LW225	LC440T	LC444W	LC610E		LC610T	LC610W	LC610A	LW610	LC603Z
	3,18	10	3,8			RDHW 1003 MO 1195-25	1068613	1070137															ECZ FCZ
	3,97	12	5			RDHW 12T3 MO 1195-35	1068614	1070147															
	3,97	12	3,8			RDHX 12T3 MO 1195-36	1070156	1070156															
	4,76	16	5,2			RDHW 1604 MO 1195-45	1068616	1070167															
	3,18	10	3,8			RDKT 1003 MO-TT	1055739 ¹⁾																ECZ
	3,18	10	3,8			RDKT 1003 MO						1070170											
	3,97	12	5			RDKT 12T3 MO-TT	1055737 ¹⁾																ECZ FCZ
	3,97	12	3,8			RDKX 12T3 MO-TT	1055738 ¹⁾																
	3,97	12	3,8			RDKX 12T3 MO						1070176											
	4,76	16	5,2			RDKT 1604 MO-TT	1055736 ¹⁾																
	4,76	16	5,2			RDKT 1604 MO						1070180											

¹⁾ LC280TT Schruppgeometrie mit 2-fach Beschichtung
 Roughing geometry with double coating

Sortenbeschreibung/-bezeichnung und ISO-Code ab Seite 22
 Description/Designation of grades and ISO-Code starting page 22

<p>FCZ 11350</p> 									
									
d ₁	d ₄	h	d ₂	z 	Ident No.	LMT-Code	Wendeplatte Insert	Ident No.	Ident No.
42	10	40	16	5	1043227	FCZ R10.042AN	RDHW1003MO	1044981	1048335 T15
52	10	40	22	6	1043228	FCZ R10.052AN			
52	12	40	22	5	1043229	FCZ R12.052AN-B	RDHX12T3MO	1045105	1048335 T15
66	12	50	27	6	1043230	FCZ R12.066AN-B			
52	12	40	22	5	1037402	FCZ R12.052AN	RDHW12T3MO	1045123	1048344 T20
66	12	50	27	6	1037404	FCZ R12.066AN			
66	16	50	27	5	1037406	FCZ R16.066AN			
80	16	50	27	6	1037408	FCZ R16.080AN	RDHW1604MO	1044990	

Schnittwertempfehlungen ab Seite 220
Cutting data recommendations starting page 220

Besondere Merkmale:

Zum Kopierfräsen, Radiusfräsen, Konturenfräsen von Formen und Gesenken
Durch seitliche und stirnseitige Freistellung der Rundplatte zum Axial- oder Schrägeintauchen geeignet
Cat.-No. ECZ als Sonderausführung auch in besonders großen Längen lieferbar

Special features:



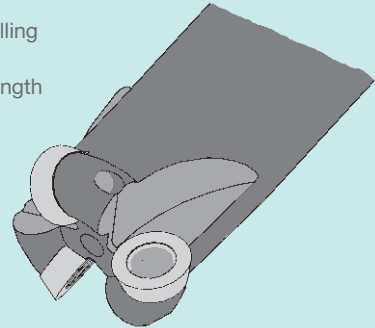

For copy milling, radius milling, contour milling of moulds and dies
Radial and axial clearances enables this milling system to plunge and ramp
Cat.-No. ECZ also available in extra long length as special designs

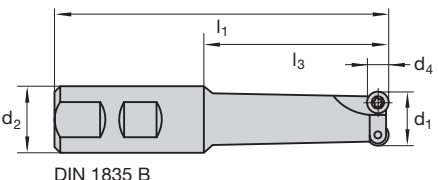

N = Anzahl der Schneidkanten N = Number of cutting edges						ISO-Code Cat-No.	Schneidstoffsorten Cutting materials Ident No.											Für Fräser For cutter Cat-No.									
	l	s	d	d ₁	b/r		LC240T	LC240S	LC230F	LC225T	LC225S	LC630T	LW240	LW225	LC440T	LC444W	LC610E		LC610T	LC610W	LC610A	LW610	LC603Z				
	2,38	8	2,8			RDHW 0802 MO 1195-15	1068612	1070129			1070127										1068621			1070123	1055758	ECZ	
	3,18	10	3,8			RDHW 1003 MO 1195-25	1068613	1070137			1070135										1068623			1070132	1055759		
	3,97	12	5			RDHW 12T3 MO 1195-35	1068614	1070147			1070145										1068625			1070142	1055760		
	2,38	8	2,8			RDKT 0802 MO-TT	1055740 ¹⁾																			ECZ	
	3,18	10	3,8			RDKT 1003 MO-TT	1055739 ¹⁾																				
	3,18	10	3,8			RDKT 1003 MO						1070170												1070172			
	3,97	12	5			RDKT 12T3 MO-TT	1055737 ¹⁾																			ECZ FCZ	

¹⁾ LC280TT Schruppgeometrie mit 2-fach Beschichtung
Roughing geometry with double coating

Sortenbeschreibung/-bezeichnung und ISO-Code ab Seite 22
Description/Designation of grades and ISO-Code starting page 22

ECZ 11460							 		  	
d ₁	d ₄	l ₁	l ₃	d ₂	z	Ident No.	LMT-Code	Wendeplatte Insert	Ident No.	Ident No.
20	8	125	69	25	2	1043032	ECZ R08.020BS125	RDHW0802MO	1044972	1048326 T8
25	10	86	36	20	2	1043039	ECZ R10.025BI086	RDHW1003MO	1044981	1048335 T15
25	10	125	69	25	2	1043038	ECZ R10.025BN125			
25	10	200	144	25	2	1043040	ECZ R10.025BN200			
32	12	86	36	20	3	1043043	ECZ R12.032BB086	RDHW12T3MO	1045123	1048344 T20
32	12	135	75	32	3	1043042	ECZ R12.032BN135			
32	12	160	100	32	3	1043044	ECZ R12.032BN160			
40	12	135	75	32	4	1043048	ECZ R12.040BF135			
40	12	180	120	32	4	1043050	ECZ R12.040BF180			

Schnittwertempfehlungen ab Seite 220
Cutting data recommendations starting page 220

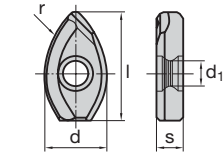
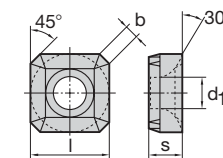
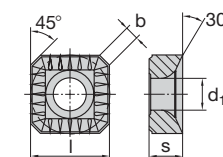
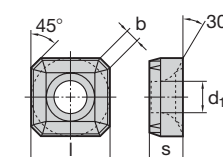
N = Anzahl der Schneidkanten N = Number of cutting edges						ISO-Code Cat-No.	Schneidstoffsorten Cutting materials												Für Fräser For cutter Cat-No.						
							Ident No.																		
	l	s	d	d ₁	b/r		LC240T	LC240S	LC230F	LC225T	LC225S	LC630T	LW240	LW225	LC440T	LC444W	LC610E	LC610T		LC610W	LC610A	LW610	LC6603Z		
 N = 2 s = ± 0,025 d = ± 0,01	12,79	3,18	7,15	3,5	10	1179-25	1069560	1069560															EBT X		
	15,99	3,97	8,94	4,1	12,5	1179-35	1069563	1069563																	
	20,47	5,08	11,44	4,5	16	1179-45	1069565	1069565																	
	25,58	6,35	14,3	5,5	20	1179-55	1069567	1069567																	
	21,55	6,35	14,3	5,5	25	1179-65	1069569	1069569																	
 N = 4	9,52	4,76		4,4	1,5	SNKX 0904 AN 1187-00	1052316	1052294	1068006															EBT X	
	12,7	5,56		5,2	2	SNKX 1205 AN 1187-10	1052301	1052230	1068007	1052315	1052228														
 N = 4	12,7	5,56		5,2	2	SNKX 1205 AN-TR 1187-10 TR	1052248	1052245		1052239	1052237													EBT X	
	12,7	5,56		5,2	2	SNKX 1205 AN-TT breite Schneidkantenfase wide land	1055742 ¹⁾																		
 N = 4	12,7	5,44		5,2	2	SNKX 1205 AN-T 1187-12 breite Schneidkantenfase wide land	1052303	1052258	1068008	1052314	1052256													EBT X	
	9,52	4,76		4,4	1,5	SNKX 0904 AN-TT	1055743 ¹⁾																		

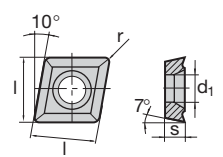
N = Anzahl der Schneidkanten N = Number of cutting edges						ISO-Code	Schneidstoffsorten Cutting materials										Für Fräser For cutter Cat-No.						
							Ident No.																
	l	s	d	d ₁	b/r		LC240T	LC230F	LC225T	LC225S	LW225	LC440T	LC444W	LC610E	LC610T	LC610W		LC610A	LW610				
 N = 2	6,35	2,38	6,35	2,8	0,4	CCMT 060204	●		●	●	●			●									ESP90
	7,94	3,18	7,94	3,4	0,8	CCMT 080308	●		●	●	●			●									

¹⁾ LC280TT Schruppgeometrie mit 2-fach Beschichtung
 Roughing geometry with double coating

Sortenbeschreibung/-bezeichnung und ISO-Code ab Seite 22
 Description/Designation of grades and ISO-Code starting page 22

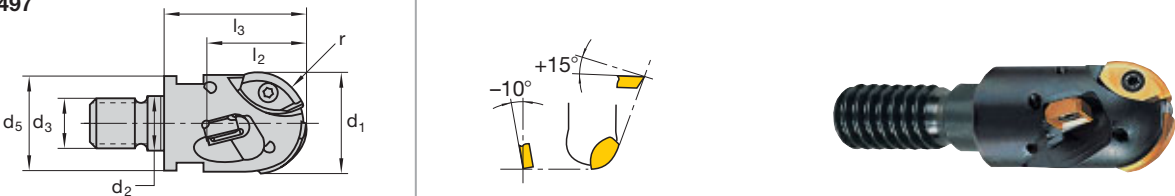
EBT THR 11497													
d_1	r	l_2	l_3	d_2	d_3	d_5	Ident No.	LMT-Code	Wendeplatte Insert	Ident No.	Wendeplatte Insert	Ident No.	Ident No.
20	10	20	32	10,5	M10	18	1041090	EBT X12.020TS032	CCMT060204	1044972	1179-25	2237513	1048326 T8
25	12,5	24	36	12,5	M12	21	1041076	EBT X16.025TF036	CCMT080308	2237513	1179-35	1045114	1048335 T15
32	16	29	45	17	M16	29	1041077	EBT X20.032TH045	SNKX0904AN	1045114	1179-45	1045126	1048335 T15
40	20	37	56	21	M20	36	1041078	EBT X25.040TI056	SNKX1205AN	1045123	1179-55	1045777	1048344 T20
50	25	43	56	25	M24	46	1041079	EBT X21.050TJ056			1179-65		



Schnittwertempfehlungen ab Seite 220
 Cutting data recommendations starting page 220



N = Anzahl der Schneidkanten N = Number of cutting edges						ISO-Code Cat-No.	Schneidstoffsorten Cutting materials											Für Fräser For cutter Cat-No.							
							Ident No.																		
	l	s	d	d ₁	b/r		LC240T	LC240S	LC230F	LC225T	LC225S	LC630T	LW240	LW225	LC440T	LC444W	LC610E		LC610T	LC610W	LC610A	LW610	LC6603Z		
<p>N = 2 s = ± 0,025 d = ± 0,01</p>	12,79	3,18	7,15	3,5	10	1179-25	1069560	1069560															EBT X		
	15,99	3,97	8,94	4,1	12,5	1179-35	1069563	1069563																	
	20,47	5,08	11,44	4,5	16	1179-45	1069565	1069565																	
	25,58	6,35	14,3	5,5	20	1179-55	1069567	1069567																	
	21,55	6,35	14,3	5,5	25	1179-65	1069569	1069569																	
<p>N = 4</p>	9,52	4,76		4,4	1,5	SNKX 0904 AN 1187-00	1052316	1052294	1068006															EBT X	
	12,7	5,56		5,2	2	SNKX 1205 AN 1187-10	1052301	1052230	1068007	1052315	1052228														
<p>N = 4</p>	12,7	5,56		5,2	2	SNKX 1205 AN-TR 1187-10 TR	1052248	1052245																EBT X	
	12,7	5,56		5,2	2	SNKX 1205 AN-TT breite Schneidkantenfase wide land	1055742 ¹⁾																		
<p>N = 4</p>	12,7	5,44		5,2	2	SNKX 1205 AN-T 1187-12 breite Schneidkantenfase wide land	1052303	1052258	1068008	1052314	1052256													EBT X	
	9,52	4,76		4,4	1,5	SNKX 0904 AN-TT	1055743 ¹⁾																		

N = Anzahl der Schneidkanten N = Number of cutting edges						ISO-Code	Schneidstoffsorten Cutting materials											Für Fräser For cutter Cat-No.						
							Ident No.																	
	l	s	d	d ₁	b/r		LC240T	LC230F	LC225T	LC225S	LW225	LC440T	LC444W	LC610E	LC610T	LC610W	LC610A		LW610					
<p>N = 2</p>	6,35	2,38	6,35	2,8	0,4	CCMT 060204	●		●	●	●			●										ESP90
	7,94	3,18	7,94	3,4	0,8	CCMT 080308	●		●	●	●			●										

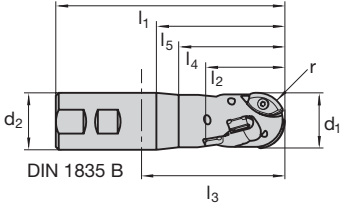
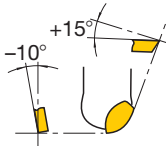



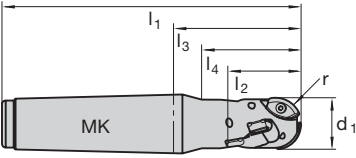
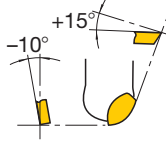

¹⁾ LC280TT Schruppgeometrie mit 2-fach Beschichtung
Roughing geometry with double coating

Sortenbeschreibung/-bezeichnung und ISO-Code ab Seite 22
Description/Designation of grades and ISO-Code starting page 22

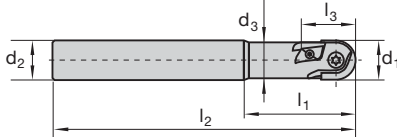
EBT 11493										  				
d ₁	r	l ₁	l ₂	l ₄	l ₅	l ₃	d ₂	Ident No.	LMT-Code	Wendepatte Insert	Ident No.	Wendepatte Insert	Ident No.	Ident No.
20	10	135	30	40	60	79	25	1041048	EBT X12.020BS135	CCMT060204	1044972	1179-25	2237513	1048326
20	10	160	30	40	85	104	25	1041049	EBT X12.020BS160					T8
25	12,5	120	35	54	54	54	25	1041067	EBT X16.025BN120	CCMT080308	2237513	1179-35	1045114	1048335
25	12,5	170	35	50	90	110	32	1041068	EBT X16.025BV170					T15
32	16	150	40	70	70	90	32	1041069	EBT X20.032BN150	SNKX0904AN	1045114	1179-45	1045126	1048335
32	16	200	40	60	115	130	40	1041070	EBT X20.032BW200					T15
40	20	145	55	80	80	85	32	1041071	EBT X25.040BF145	SNKX1205AN	1045123	1179-55	1045777	1048344
40	20	200	55	115	115	130	40	1041072	EBT X25.040BN200					T20

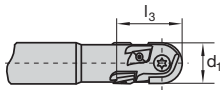
EBT 11490										  				
d ₁	r	l ₂	l ₃	d ₂	d ₃	d ₅	Ident No.	LMT-Code	Wendepatte Insert	Ident No.	Wendepatte Insert	Ident No.	Ident No.	
20	10	146	30	40	65	3	1041080	EBT X12.020M3146	CCMT060204	1044972	1179-25	1044972	1048326	
25	12,5	146	35	60	65	3	1041081	EBT X16.025M3146	CCMT080308	2237513	1179-35	2237513	1048335	
32	16	179	40	70	76,5	4	1041082	EBT X20.032M4179	SNKX0904AN	1045114	1179-45	1045114	1048335	
32	16	210	40	101	107,5	4	1041083	EBT X20.032M4210				1045126	T15	
40	20	200	55	91	97,5	4	1041084	EBT X25.040M4200	SNKX1205AN	1045123	1179-55	1045777	1048334	
40	20	236	55	75	106,5	5	1041085	EBT X25.040M5236					T20	
50	25	231	60	95	101,5	5	1043234	EBT X21.050M5231	SNKX1205AN	1045123	1179-66	1045777		
50	25	260	60	124	130,5	5	1041086	EBT X21.050M5260			1179-65			

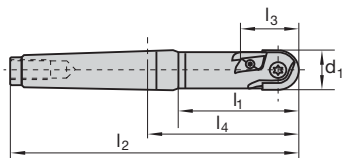
Schnittwertempfehlungen ab Seite 220
 Cutting data recommendations starting page 220

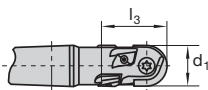
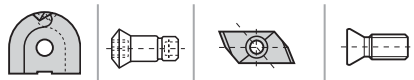
EBG T (GRT) 										 <p>für Modellbau-Werkstoffe for materials in model making industries</p>			
GRT 25 ... 25-RZ-A/080/120													
													
GRT 32 ... 32-RZ-A/080/120													
													
GRT 25 ... 3-MK-A/080/120													
													
GRT32 ... 3-MK-A/080/120													
d ₁	l ₁	l ₂	l ₃	l ₄	d ₂	d ₃	MK	LMT Code	Ident No.	Wendeplatten Inserts	Schraube Screw	Wendeplatten Inserts	Schraube Screw
25	70	190	46		25	23		EBG T25.025AN190 (GRT 25 190 25-RZ-A)	K121222	WR_ 25	GWS 25	2 x WP_-A	SA 40 115
25	100	190	80		25	23		EBG T25.025AN190-080 (GRT 25 190 25-RZ-A-080)	K121224	WRS 25	GWS 25	5 x WPS-A	
25	140	230	120		25	23		EBG T25.025AN230-120 (GRT 25 230 25-RZ-A-120)	K121223	WRS 25	GWS 25	9 x WPS-A	
32	80	210	49		32	29		EBG T32.032AN210 (GRT 32 210 32-RZ-A)	K121225	WR_ 32	GWS 32	4 x WP_-A	
32	100	210	80		32	29		EBG T32.032AN210-080 (GRT 32 210 32-RZ-A-080)	K121227	WRS 32	GWS 32	10 x WPS-A	
32	140	250	120		32	29		EBG T32.032AN250-120 (GRT 32 250 32-RZ-A-120)	K121226	WRS 32	GWS 32	16 x WPS-A	
25	70	170	46	89	23	3		EBG T25.025M3170 (GRT 25 170 3-MK-A)	K121212	WR_ 25	GWS 25	2 x WP_-A	SA 40 115
25	100	190	80	109	23	3		EBG T25.025M3170-080 (GRT 25 190 3-MK-A-080)	K121214	WRS 25	GWS 25	5 x WPS-A	
25	140	230	120	149	23	3		EBG T25.025M3230-120 (GRT 25 230 3-MK-A-120)	K121213	WRS 25	GWS 25	9 x WPS-A	
32	70	190	49	87,5	29	4		EBG T32.032M4190 (GRT 32 190 4-MK-A)	K121215	WR_ 32	GWS 32	4 x WP_-A	
32	100	210	80	107,5	29	4		EBG T32.032M4190-080 (GRT 32 210 4-MK-A-080)	K121217	WRS 32	GWS 32	10 x WPS-A	
32	140	250	120	147,5	29	4		EBG T32.032M4250-120 (GRT 32 250 4-MK-A-120)	K121216	WRS 32	GWS 32	16 x WPS-A	

N = Anzahl der Schneidkanten N = Number of cutting edges						ISO-Code Cat-No.	Schneidstoffsorten Cutting materials Ident No.											Für Fräser For cutter Cat-No.									
	l	s	d	d ₁	r		LC225N	LC240N	LC240T	LC240S	LC230F	LC225T	LC225S	LC630T	LW240	LW225	LC440T		LC444W	LC610E	LC610T	LC610W	LC610A	LW610	LC603Z		
 N = 2		4	25			WRT 25		K122404							K200211											EBG T (GRT)	
		5	32			WRT 32		K122389							K200213						K122387	K122388		K122400			
 N = 2		4	25			WRX 25		K122378							K122390												EBG T (GRT)
		5	32			WRX 32		K122385							K122379						K122383	K122384		K122382			
 N = 2	6	8	12			WPT-A		K122422							K122414												EBG T (GRT)
 N = 2		4	25			WRS 25 ¹⁾																					EBG T (GRT)
		5	32			WRS 32 ¹⁾																					
 N = 2	12	6				WPS-A ¹⁾																					EBG T (GRT)

¹⁾ Für die Bearbeitung von Modellbauwerkstoffen
¹⁾ For machining materials in model making industry

Sortenbeschreibung/-bezeichnung und ISO-Code ab Seite 22
Description/Designation of grades and ISO-Code starting page 22

	LMT Code	Ident No.	L mm	Torx für Torx Schraubendreher for Torx screwdriver		Auszugsmomente (Nm) Torque (Nm)	
 Befestigungsschraube für Wendeplatte Fixing Screw for inserts	GWS 25	K119562	20,4	T 30	6,5		
	GWS 32	K119563	24,8				
	SA 40 115	K119512		T 8	von Hand manual		
 Torx-Schraubendreher Torx screwdriver	T 8	K119528					
	T 30	K119533					
 Drehmomentschlüssel/Satz Torque spanner/set		K127291		Inhalt (je 1 Stück): Content (1 pc. each):			
						T20 T30 SW3	
	Einsätze (Ersatz) Bits (Spare)	T 20 T 30	K119519 K119520				

Twincut-Kugel-Kopieraufschraubfräser
Twincut Ball Nose screw on type Copying End Mills

Besondere Merkmale:

Negativer Axialwinkel kombiniert mit positiver Hohlkehle ergibt weichen, schälenden Schnitt
Formwendeplatte mit Hohlkehlen
2 Wendeplatten, halbrund, beidseitig nutzbar, Zylinderschliff, hohe Formgenauigkeit. In Verbindung mit Linksfräsern 4fach wendbar
Hohe Spannsicherheit und Lagegenauigkeit
Stabiler Rückenquerschnitt

Special features:

Negative axial angle combined with positive groove generates a smooth skiving cutting action
Chip forming insert
2 indexable inserts, half round, both sides can be used, cylindrically ground, high accuracy of form on left hand cutters to be used and turned over 4 times
Secure and precise clamping
Stable rear cross-section

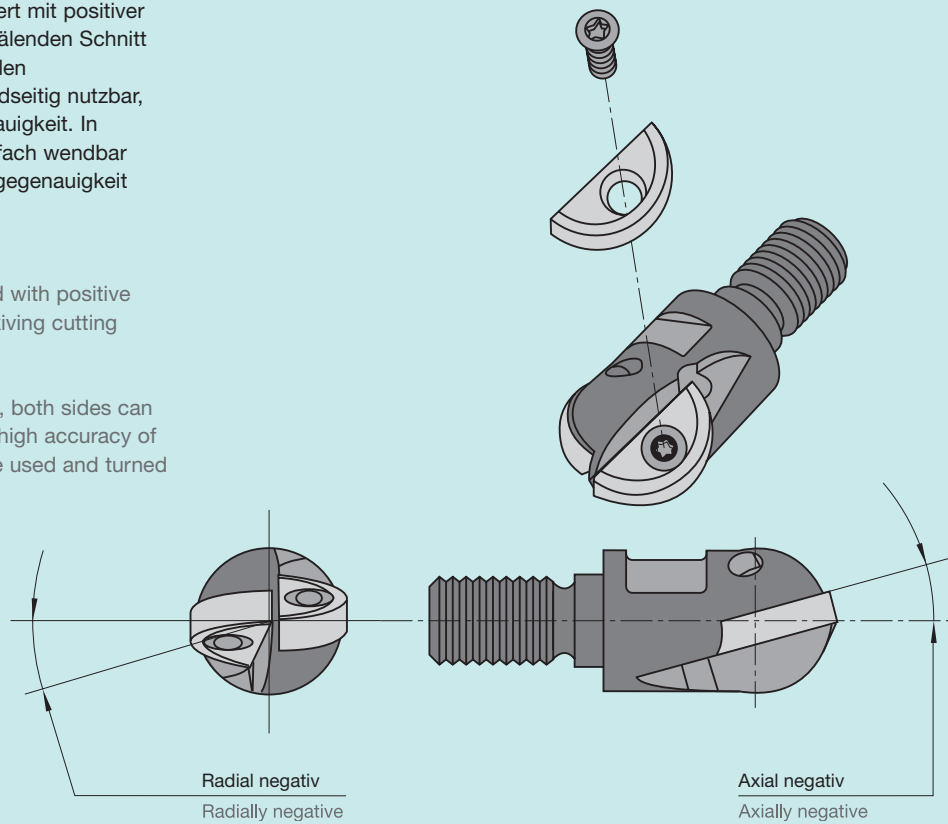

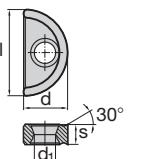
N = Anzahl der Schneidkanten N = Number of cutting edges						ISO-Code Cat-No.	Schneidstoffsorten Cutting materials Ident No.											Für Fräser For cutter Cat-No.							
	l	s	d	d ₁	b/r		LC240T	LC240S	LC230F	LC225T	LC225S	LC630T	LW240	LW225	LC440T	LC444W	LC610E		LC610T	LC610W	LC610A	LW610	LC603Z		
 N = 2 s = ± 0,01 l = ± 0,02 d = ± 0,01	15,191	3,18	7,04	3,4	8 ¹⁾	1179-11	1069575	1069617		1069573	1069626														
	18,989	3,97	8,80	4,2	10 ¹⁾	1179-21	1069581	1069619		1069579	1069629						1069583				1069628				
	23,736	4,76	11	5,2	12,5 ¹⁾	1179-31	1069585	1069621		1069584	1069633						1069587				1069631				
	28,48	5,23	13,2	5,5	15 ¹⁾	1179-40	1069641	1069557		1069559	1069556						1069642				1069555				
	30,382	5,56	14,08	5,8	16 ¹⁾	1179-41	1069589	1069622		1069636				1069634			1069571				1069635				

¹⁾ Radius am Werkstück
¹⁾ Radius on workpiece

Sortenbeschreibung/-bezeichnung und ISO-Code ab Seite 22
Description/Designation of grades and ISO-Code starting page 22

Twincut-Kugel-Kopieraufschraubfräser
Twincut Ball Nose screw on type Copying End Mills

EBT 11434														
d ₁	r	l ₃	d ₂	d ₅	d ₃	z	Ident No.	LMT-Code	Wendepatte Insert	Ident No.	Ident No.			
16	8	25	8,5	12	M 8	2	1040991	EBT R16.016TR025	1179-11	2237513	1048326			
20	10	26	10,5	16	M 10	2	1040999	EBT R20.020TS026	1179-21	1045105	1048335			
25	12,5	33	12,5	21	M 12	2	1040925	EBT R25.025TF033	1179-31	1044963	1048344			

Verlängerungsdorne und Anschlußmaße siehe LMT-Katalog „Spannen“ ab Seite 221
 Extension arbors and fitting dimensions refer LMT Catalogue “Chucking” starting page 221

Twincut-Kugel-Kopierfräser, Zweischneider
Twincut Ball Nose Copying Mills, two flutes

EBT 11432														
d ₁	r	Form	d ₃	l ₁	l ₃	d ₂	z	Ident No.	LMT-Code	Wendepatte Insert	Ident No.	Ident No.		
16	8	B ¹⁾		86	36	20	2	1040911	EBT R16.016BR086	1179-11	2237513	1048326		
16	8	A	14	160	55	16	2	1040902	EBT R16.016AN160					
16	8	B		175	65	20	2	1040913	EBT R16.016AR175	1179-21	1045105	1048335		
20	10	A ¹⁾	17,2	86	36	20	2	1040927	EBT R20.020BN086					
20	10	A	17,2	175	60	20	2	1040904	EBT R20.020AN175					
20	10	B		190	80	25	2	1040914	EBT R20.020AS190					
25	12,5	A ¹⁾	21,5	86	36	20	2	1040929	EBT R25.025BS190	1179-31	1044963	1048344		
25	12,5	A	21,5	190	70	25	2	1040905	EBT R25.025AN190					
25	12,5	B		210	100	32	2	1040915	EBT R25.025AV210	1179-40	1045777	1048344		
30	15	A	26	210	80	32	2	1040928	EBT R30.030AP210					
32	16	A	28	210	80	32	2	1040906	EBT R32.032AN210					

¹⁾ DIN 1835 B

Form A: Überlaufschaft Straight standard shank
 Form B: Verstärkter Schaft Shank dia. increased

Schnittwertempfehlungen ab Seite 220
 Cutting data recommendations starting page 220



EBG R (GWR)											
d ₁	l ₁	l ₂	d ₂	d ₃	z	LMT Code	Ident No.	mit IKZ with internal cooling	Wendeplatten Inserts	Wendeplatten Inserts	Ident No.
6	40	100	6	5,8	2	EBG R06.006AN100-C (GWR 06 100 06-RZ-HM)	K130088	-	WPR 06	WPB 06	GWS 06 T 6
6	70	150	6	5,8	2	EBG R06.006AN150-C (GWR 06 100 06-RZ-HM)	K130086	-	WPR 06	WPB 06	GWS 06 T 6
6	100	200	6	5,8	2	EBG R06.006AN150-C (GWR 06 100 06-RZ-HM)	K130084	-	WPR 06	WPB 06	GWS 06 T 6
6	16	100	8	5,3	2	EBG R06.006AP100-C (GWR 06 100 08-HM)	K128437	-	WPR 06	WPB 06	GWS 06 T 6
8	25	100	8	7	2	EBG R08.008AN100-C (GWR 08 100 08-HM)	K121301	-	WPR 08		GWS 08 T 8
8	40	150	8	7	2	EBG R08.008AN150-C (GWR 08 150 08-HM)	K121284	-			
10	35	120	10	8,8	2	EBG R10.010AN120-C (GWR 10 120 10-HM)	K121285	K130392	WPR 10		GWS 10 T15
10	50	150	10	8,8	2	EBG R10.010AN150-C (GWR 10 150 10-HM)	K121286	K130393			
12	35	120	12	10,5	2	EBG R12.012AN120-C (GWR 12 120 12-HM)	K121287	K130394	WPR 12		GWS 12 T20
12	50	160	12	10,5	2	EBG R12.012AN160-C (GWR 12 160 12-HM)	K121288	K130395			
16	40	140	16	14	2	EBG R16.016AN140-C (GWR 16 140 16-HM)	K121289	K130396	WPR 16		GWS 16 T20
16	55	175	16	14	2	EBG R16.016AN175-C (GWR 16 175 16-HM)	K121290	K130397			
20	50	140	20	18	2	EBG R20.020AN140-C (GWR 20 140 20-HM)	K121291	K130398	WPR 20		GWS 20 T20
20	75	190	20	18	2	EBG R20.020AN190-C (GWR 20 190 20-HM)	K121292	K130399			
25	60	160	25	22,4	2	EBG R25.025AN160-C (GWR 25 160 25-HM)	K121275	K130400	WPR 25		GWS 25 T30
25	90	210	25	22,4	2	EBG R25.025AN210-C (GWR 25 210 25-HM)	K121276	K130401			
32	65	190	32	28,6	2	EBG R32.032AN190-C (GWR 32 190 32-HM)	K121277	-	WPR 32		GWS 32 T30
32	105	240	32	28,6	2	EBG R32.032AN240-C (GWR 32 240 32-HM)	K121278	-			

	LMT Code	Ident No.	L mm	Torx		Auszugsmomente (Nm)	
				für Torx Schraubendreher for Torx screwdriver		Torque (Nm)	
Befestigungsschraube für Wendeplatte Fixing Screw for inserts	GWS 06	K260409	5,0	T 6	von Hand manual		
	GWS 08	K119572	6,9	T 8			
	GWS 10	K119571	8,4	T 15			
	GWS 12	K119559	9,1	T 20			
	GWS 16	K119560	12,8				
	GWS 20	K119561	15,5				
	GWS 25	K119562	20,4	T 30			
	GWS 32	K119563	24,8				
Torx-Schraubendreher Torx screwdriver	T 6	K119544					
	T 8	K119528					
	T 15	K119529					
	T 20	K119530					
	T 30	K119533					
Drehmomentschlüssel/Satz Torque spanner/set Einsätze (Ersatz) Bits (Spare)	T 20	K119519		Inhalt (je 1 Stück): Content (1 pc. each):		T20	
	T 30	K119520				T30	
						SW3	

EBG R (GWR)										
d ₁	l ₁	l ₂	d ₂	d ₃	z	LMT Code	Ident No.	Wendeplatten Inserts	Ident No.	
12	32	130	12	10,5	2	EBG R12.012AN090 (GWR 12 130 12-RZ)	K130568	WPR 12	GWS 12 T20	
12	46	150	12	10,5	2	EBG R12.012AN150 (GWR 12 130 12-RZ)	K121395			
12	32	90	12	10,5	2	EBG R12.012AN150 (GWR 12 150 12-RZ)	K121397	WPR 16	GWS 16 T20	
16	36	100	16	14	2	EBG R16.016AN100 (GWR 16 100 16-RZ)	K130569			
16	36	140	16	14	2	EBG R16.016AN140 (GWR 16 140 16-RZ)	K121385			
16	53	160	16	14	2	EBG R16.016AN160 (GWR 16 160 16-RZ)	K121387			
20	45	160	20	18	2	EBG R20.020AN160 (GWR 20 160 20-RZ)	K121382	WPR 20	GWS 20 T20	
20	61	175	20	18	2	EBG R20.020AN175 (GWR 20 175 20-RZ)	K121375			
25	45	160	25	22,4	2	EBG R25.025AN160 (GWR 25 160 25-RZ)	K121367	WPR 25	GWS 25 T30	
25	70	190	25	22,4	2	EBG R25.025AN190 (GWR 25 190 25-RZ)	K121369			
30	56	175	32	27	2	EBG R30.030AP175 (GWR 30 175 32-RZ)	K200387	WPR 30	GWS 32 T30	
30	80	210	32	27	2	EBG R30.030AP210 (GWR 30 210 32-RZ)	K121350			
32	56	175	32	28,6	2	EBG R32.032AN175 (GWR 32 175 32-RZ)	K121359	WPR32		
32	80	210	32	28,6	2	EBG R32.032AN210 (GWR 32 210 32-RZ)	K121361			

	LMT Code	Ident No.	L mm	Torx für Torx Schraubendreher for Torx screwdriver	Auszugsmomente (Nm) Torque (Nm)		
	Befestigungsschraube für Wendeplatte Fixing Screw for inserts	GWS 12	K119559	9,1	T 20		
		GWS 16	K119560	12,8			
		GWS 20	K119561	15,5			
		GWS 25	K119562	20,4			
		GWS 32	K119563	24,8			
	Torx-Schraubendreher Torx screwdriver	T 20	K119530				
		T 30	K119533				
	Drehmomentschlüssel/Satz Torque spanner/set	K180043		Inhalt (je 1 Stück): Content (1 pc. each):		T20 T30 SW3	
		Einsätze (Ersatz) Bits (Spare)	T 20				K119519
			T 30				K119520



Wendeschneidplatten ab Seite 206
Indexable Inserts starting page 206



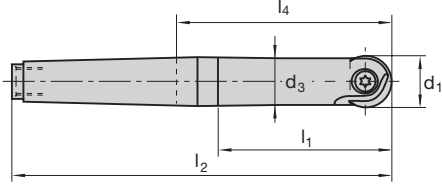

EBG R (GWR)

d ₁	l ₁	l ₂	d ₂	d ₃	z	LMT Code	Ident No.	Wendeplatten Inserts	Wendeplatten Inserts	Ident No.
6	16	90	10	5,3	2	EBG R06.006AR090 (GWR 06 090 10-RZK)	K128481	WPR 06	WPB 06	GWS 06 T 6
8	50	95	12	7,5	2	EBG R08.008AR095 (GWR 08 95 12-RZK)	K130570	WPR 08	WPV/B 08	GWS 08 T 8
8	50	140	12	7,5	2	EBG R08.008AR140 (GWR 08 140 12-RZK)	K121409			
10	35	85	12	9	2	EBG R10.010AP085 (GWR 10 85 12-RZK)	K130571	WPR 10	WPV/B 10	GWS 10 T15
10	35	150	12	9	2	EBG R10.010AP150 (GWR 10 150 12-RZK)	K121401			
12	60	110	16	10,5	2	EBG R12.012AR110 (GWR 12 110 16-RZK)	K130572	WPR 12		GWS 12 T20
12	60	160	16	10,5	2	EBG R12.012AR160 (GWR 12 160 16-RZK)	K121402			
16	67	120	20	14	2	EBG R16.016AR120 (GWR 16 120 20-RZK)	K130573	WPR 16		GWS 16 T20
16	67	175	20	14	2	EBG R16.016AR175 (GWR 16 175 20-RZK)	K121403			
20	80	190	25	18	2	EBG R20.020AS190 (GWR 20 190 25-RZK)	K121404	WPR 20		GWS 20 T20
25	100	210	32	22,4	2	EBG R25.025AV210 (GWR 25 210 32-RZK)	K121405	WPR 25		GWS 25 T30
32	123	240	40	28,6	2	EBG R32.032AW240 (GWR 32 240 40-RZK)	K121392	WPR 32		GWS 32 T30

	LMT Code	Ident No.	L mm	Torx für Torx Schraubendreher for Torx screwdriver	Auszugsmomente (Nm) Torque (Nm)
<p>Befestigungsschraube für Wendeplatte Fixing Screw for inserts</p>	GWS 06	K260409		T 6	von Hand manual
	GWS 08	K119572	6,9	T 8	
	GWS 10	K119571	8,4	T 15	
	GWS 12	K119559	9,1	T 20	
	GWS 16	K119560	12,8		
	GWS 20	K119561	15,5		
	GWS 25	K119562	20,4	T 30	
<p>Torx-Schraubendreher Torx screwdriver</p>	T 6	K119544			
	T 8	K119528			
	T 15	K119529			
	T 20	K119530			
	T 30	K119533			
<p>Drehmomentschlüssel/Satz Torque spanner/set</p>		K180043		Inhalt (je 1 Stück): Content (1 pc. each):	T20 T30 SW3
	Einsätze (Ersatz) Bits (Spare)	T 20	K119519		
		T 30	K119520		

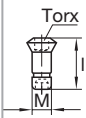
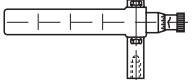
Wendeschneidplatten ab Seite 206
Indexable Inserts starting page 206

EBG R (GWR)											
d ₁	l ₁	l ₂	MK	d ₃	l ₄	z	LMT Code	Ident No.	Wendeplatten Inserts	Ident No.	
12	36	115	2	10,5	51	2	EBG R12.012M2115 (GWR 12 115 2-MK)	K121337	WPR 12	GWS 12 T20	
12	53	130	2	10,5	66	2	EBG R12.012M2130 (GWR 12 130 2-MK)	K121320			
16	36	115	2	14	51	2	EBG R16.016M2115 (GWR 16 115 2-MK)	K121323	WPR 16	GWS 16 T20	
16	53	130	2	14	66	2	EBG R16.016M2130 (GWR 16 130 2-MK)	K121324			
20	45	125	2	17,8	61	2	EBG R20.020M2125 (GWR 20 125 2-MK)	K121327	WPR 20	GWS 20 T20	
20	61	140	2	17,8	76	2	EBG R20.020M2140 (GWR 20 140 2-MK)	K121328			
25	45	145	3	22,4	64	2	EBG R25.025M3145 (GWR 25 145 3-MK)	K121315	WPR 25	GWS 25 T30	
25	70	170	3	22,4	89	2	EBG R25.025M3170 (GWR 25 170 3-MK)	K121316			
32	45	165	4	28,6	62,5	2	EBG R32.032M4165 (GWR 32 165 4-MK)	K121319	WPR 32	GWS 32 T30	
32	70	190	4	28,6	87,5	2	EBG R32.032M4190 (GWR 32 190 4-MK)	K121311			

	LMT Code	Ident No.	L mm	Torx für Torx Schraubendreher for Torx screwdriver	Auszugsmomente (Nm) Torque (Nm)		
	Befestigungsschraube für Wendeplatte Fixing Screw for inserts	GWS 12	K119559	9,1	T 20		
		GWS 16	K119560	12,8			
		GWS 20	K119561	15,5			
		GWS 25	K119562	20,4			
		GWS 32	K119563	24,8			
	Torx-Schraubendreher Torx screwdriver	T 20	K119530				
		T 30	K119533				
	Drehmomentschlüssel/Satz Torque spanner/set		K180043		Inhalt (je 1 Stück): Content (1 pc. each):		
		Einsätze (Ersatz) Bits (Spare)	T 20	K119519			
			T 30	K119520			

Wendeschneidplatten ab Seite 206
Indexable Inserts starting page 206



EBG R (GWR)

d ₁	l ₁	l ₂	d ₂	d ₃	d ₄	z	LMT Code	Ident No.	Wendeplatten Inserts	Wendeplatten Inserts	Ident No.
8	50	95	12	7,5	11,9	2	EBG R08.008DR095 (GWR 08 95 12-RSK)	K121265	WPR 08	WPV/B 08	GWS 08 T 8
8	50	140	12	7,5	11,9	2	EBG R08.008DR140 (GWR 08 140 12-RSK)	K121248			
10	35	85	12	9	11,9	2	EBG R10.010DP085 (GWR 10 85 12-RSK)	K121249	WPR 10	WPV/B 10	GWS 10 T15
10	35	150	12	9	11,9	2	EBG R10.010DP150 (GWR 10 150 12-RSK)	K121250			
12	60	110	16	10,5	15,9	2	EBG R12.012DR110 (GWR 12 110 16-RSK)	K121251	WPR 12		GWS 12 T20
12	60	160	16	10,5	15,9	2	EBG R12.012DR160 (GWR 12 160 16-RSK)	K121252			
16	67	120	20	14	19,9	2	EBG R16.016DR120 (GWR 16 120 20-RSK)	K121253	WPR 16		GWS 16 T20
16	67	172	20	14	19,9	2	EBG R16.016DR175 (GWR 16 175 20-RSK)	K121254			
20	80	140	25	18	24,9	2	EBG R20.020DS140 (GWR 20 140 25-RSK)	K121255	WPR 20		GWS 20 T20
20	80	190	25	18	24,9	2	EBG R20.020DS190 (GWR 20 190 25-RSK)	K121256			
25	100	160	32	22,4	31,9	2	EBG R25.025DV160 (GWR 25 160 32-RSK)	K121245	WPR 25		GWS 25 T30
25	100	210	32	22,4	31,9	2	EBG R25.025DV210 (GWR 25 210 32-RSK)	K121246			



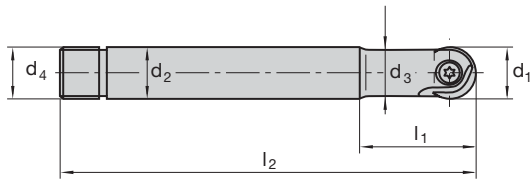

	LMT Code	Ident No.	L mm	Torx für Torx Schraubendreher for Torx screwdriver	Auszugsmomente (Nm) Torque (Nm)
<p>Torx Befestigungsschraube für Wendeplatte Fixing Screw for inserts</p>	GWS 08	K119572	6,9	T 8	<p>von Hand manual 6,0 6,0 – 6,5 6,0 – 6,5 6,5</p>
	GWS 10	K119571	8,4	T 15	
	GWS 12	K119559	9,1	T 20	
	GWS 16	K119560	12,8		
	GWS 20	K119561	15,5		
	GWS 25	K119562	20,4	T 30	
<p>Torx-Schraubendreher Torx screwdriver</p>	T 8	K119528			
	T 15	K119529			
	T 20	K119530			
	T 30	K119533			
<p>Drehmomentschlüssel/Satz Torque spanner/set Einsätze (Ersatz) Bits (Spare)</p>	T 20	K180043		<p>Inhalt (je 1 Stück): Content (1 pc. each):</p> <p>T20 T30 SW3</p>	
	T 30	K119519			
		K119520			

Wendeschneidplatten ab Seite 206
Indexable Inserts starting page 206

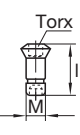
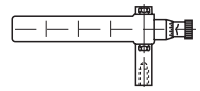

EBG R (GWR)





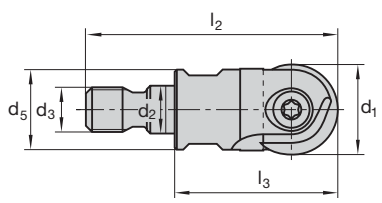

d ₁	l ₁	l ₂	d ₂	d ₃	d ₄	z	LMT Code	Ident No.	Wendeplatten Inserts	Ident No.
12	32	80	12	10,5	11,9	2	EBG R12.012DN080 (GWR 12 80 12-RS)	K121353	WPR 12	GWS 12 T20
12	46	100	12	10,5	11,9	2	EBG R12.012DN100 (GWR 12 100 12-RS)	K121354		
16	36	90	16	14	15,9	2	EBG R16.016DN090 (GWR 16 90 16-RS)	K121339	WPR 16	GWS 16 T20
16	53	110	16	14	15,9	2	EBG R16.016DN110 (GWR 16 110 16-RS)	K121340		
20	45	110	20	18	19,9	2	EBG R20.020DN110 (GWR 20 110 20-RS)	K121343	WPR 20	GWS 20 T20
20	61	125	20	18	19,9	2	EBG R20.020DN125 (GWR 20 125 20-RS)	K121344		
25	45	110	25	22,4	24,9	2	EBG R25.025DN110 (GWR 25 110 25-RS)	K121329	WPR 25	GWS 25 T30
25	70	140	25	22,4	24,9	2	EBG R25.025DN140 (GWR 25 140 25-RS)	K121330		
32	56	125	32	28,6	31,9	2	EBG R32.032DN125 (GWR 32 125 32-RS)	K121333	WPR 32	GWS 32 T30
32	80	160	32	28,6	31,9	2	EBG R32.032DN160 (GWR 32 160 32-RS)	K121334		

	LMT Code	Ident No.	L mm	Torx für Torx Schraubendreher for Torx screwdriver	Auszugsmomente (Nm) Torque (Nm)			
	Befestigungsschraube für Wendeplatte Fixing Screw for inserts	GWS 12	K119559	9,1	T 20 T 30			
		GWS 16	K119560	12,8				
		GWS 20	K119561	15,5				
		GWS 25	K119562	20,4				
		GWS 32	K119563	24,8				
	Torx-Schraubendreher Torx screwdriver	T 20	K119530					
		T 30	K119533					
	Drehmomentschlüssel/Satz Torque spanner/set		K180043		Inhalt (je 1 Stück): Content (1 pc. each):			
		Einsätze (Ersatz) Bits (Spare)	T 20	K119519				T20
			T 30	K119520				T30 SW3

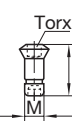
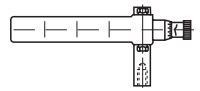
Wendeschneidplatten ab Seite 206
Indexable Inserts starting page 206

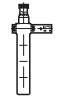
EBG R (GWR) THR									 		
d ₁	l ₃	l ₂	d ₅	d ₃	d ₂	z	LMT Code	Ident No.	Wendeplatten Inserts	Wendeplatten Inserts	Ident No.
8	30	44,5	6,5	M 6	10	2	EBG R08.008TC030 (GWR 08 30 06-THR)	K121303	WPR 08	WPV/B 08	GWS 08 T 8
10	30	44,5	6,5	M 6	10	2	EBG R10.010TC030 (GWR 10 30 06-THR)	K121304	WPR 10	WPV/B 10	GWS 10 T 15
12	30	47,5	8,2	M 8	13	2	EBG R12.012TD030 (GWR 12 30 08-THR)	K121305	WPR 12		GWS 12 T 20
12	30	47,5	8,5	M 8	13	2	EBG R12.012TR030 (GWR 12 30 85-THR)	K121306			
16	35	52,5	8,2	M 8	13	2	EBG R16.016TD035 (GWR 16 35 08-THR)	K121307	WPR 16		GWS 16 T 20
16	35	52,5	8,5	M 8	13	2	EBG R16.016TR035 (GWR 16 35 85-THR)	K121308			
20	35	54,5	10,2	M10	18	2	EBG R20.020TE035 (GWR 20 35 10-THR)	K121309	WPR 20		GWS 20 T 20
20	35	54,5	10,5	M10	18	2	EBG R20.020TS035 (GWR 20 35 15-THR)	K121310			
25	40	62	12,5	M12	21	2	EBG R25.025TF040 (GWR 25 40 12-THR)	K121293	WPR 25		GWS 25 T 30

	LMT Code	Ident No.	L mm	Torx für Torx Schraubendreher for Torx screwdriver	Auszugsmomente (Nm) Torque (Nm)	
	Befestigungsschraube für Wendeplatte Fixing Screw for inserts	GWS 08 K119572	6,9	T 8	von Hand manual 6,0 6,0 – 6,5 6,0 – 6,5 6,5 6,5	
		GWS 10 K119571	8,4	T 15		
		GWS 12 K119559	9,1	T 20		
		GWS 16 K119560	12,8			
		GWS 20 K119561	15,5			
		GWS 25 K119562	20,4	T 30		
		GWS 32 K119563	24,8			
	Torx-Schraubendreher Torx screwdriver	T 8 K119528				
		T 15 K119529				
		T 20 K119530				
		T 30 K119533				
	Drehmomentschlüssel/Satz Torque spanner/set	K180043		Inhalt (je 1 Stück): Content (1 pc. each):	T20 T30 SW3	
	Einsätze (Ersatz) Bits (Spare)	T 20 K119519				
		T 30 K119520				

Wendeschneidplatten ab Seite 206
Indexable Inserts starting page 206

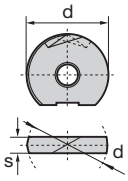
N = Anzahl der Schneidkanten N = Number of cutting edges						ISO-Code Cat-No.	Schneidstoffsorten Cutting materials Ident No.											Für Fräser For cutter Cat-No.							
	l	s	d	d ₁	r		LC225N	LC240N	LC240T	LC240S	LC230F	LC225T	LC225S	LC630T	LW240	LW225	LC440T		LC444W	LC610E	LC610T	LC610W	LC610A	LW610	LC603Z
 N = 2		2	8			WPR 08-N																			
		2,5	10			WPR 10-N	K123158	K123050	K127908						K123180	K123173				K123048	K123049		K123047		
		2,5	12			WPR 12-N	K123139	K123138	K282696						K123159	K123162				K123154	K123137		K123153		
		3	16			WPR 16-N	K123121	K123120	K127665						K123140	K123144				K123136	K123119		K123135		
		3	20			WPR 20-N	K123108	K123107	K127911						K123122	K123126				K123118	K123106		K123117		
		4	25			WPR 25-N	K123085	K123084	K128448						K180175	K123104				K123100	K123083		K123099		
		5	30			WPR 30-N	K122679	K123072	K282697						K123065					K122678	K200390		K200388		
		5	32			WPR 32-N	K123080	K127953	K127562						K180254	K123090				K123077	K123078		K123076		

Alle WPR-, WPV- und WPB-Wendeplatten sind in der Sorte LC 610A (diamantbeschichtet) oder PKD/CBN-bestückt auf Anfrage lieferbar
All WPR, WPV and WPP inserts are available in grade LC 610A (diamond coated) or PCD/CBN tipped

Sortenbeschreibung/-bezeichnung und ISO-Code ab Seite 22
Description/Designation of grades and ISO-Code starting page 22

N = Anzahl der Schneidkanten N = Number of cutting edges	Geometrie					ISO-Code Cat-No.	Schneidstoffsorten Cutting materials Ident No.											Für Fräser For cutter Cat-No.							
	l	s	d	d ₁	r		LC225N	LC240N	LC240T	LC240S	LC230F	LC225T	LC225S	LC630T	LW240	LW225	LC440T		LC444W	LC610E	LC610T	LC610W	LC610A	LW610	LC603Z
<p>N = 2</p>		2	8			WPR 08-CF																			EBG R (GWR)
		2,5	10			WPR 10-CF	K123038	K123046	K282700											K122964	K122949		K122963		
		2,5	12			WPR 12-CF	K123028	K123027	K282703											K123044	K123045		K123043		
		3	16			WPR 16-CF	K123010	K123009	K282705											K123007	K123008		K123006		
		3	20			WPR 20-CF	K122992	K122991	K282709											K123005	K122990		K123004		
		4	25			WPR 25-CF	K122988	K122987	K128868											K122985	K122986		K122984		
		5	30			WPR 30-CF		K122967	K282712											K200286	K122966		K122965		
		5	32			WPR 32-CF	K122971	K122970	K282714											K122980	K122981		K122979		

CF = Spanleitstufe für langspanende Eisenwerkstoffe
 CF = Chip Control Geometry for longchipping ferrous materials
 Alle WPR-, WPV- und WPB-Wendeplatten sind in der Sorte LC 610A
 (diamantbeschichtet) oder PKD/CBN-bestückt auf Anfrage lieferbar
 All WPR, WPV and WPP inserts are available in grade LC 610A
 (diamond coated) or PCD/CBN tipped

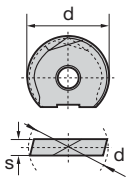

Sortenbeschreibung/-bezeichnung und ISO-Code ab Seite 22
 Description/Designation of grades and ISO-Code starting page 22

N = Anzahl der Schneidkanten N = Number of cutting edges						ISO-Code Cat-No.	Schneidstoffsorten Cutting materials Ident No.											Für Fräser For cutter Cat-No.				
	l	s	d	d ₁	r		LC240T	LC240S	LC230F	LC225T	LC225S	LC630T	LW240	LW225	LC440T	LC444W	LC610E		LC610T	LC610W	LC610A	LW610
 N = 2		2	8			WPR 08-CN											K200289	K122915		K122914		
		2,5	10			WPR 10-CN											K200292	K122954		K122953		
		2,5	12			WPR 12-CN											K200293	K122948		K122947		
		3	16			WPR 16-CN											K200294	K122934		K122933		
		3	20			WPR 20-CN											K200295	K122940		K122939		
		4	25			WPR 25-CN											K200296	K122929		K122928		
		5	30			WPR 30-CN											K122924	K122916		K122923		
		5	32			WPR 32-CN											K282722	K122918		K122917		

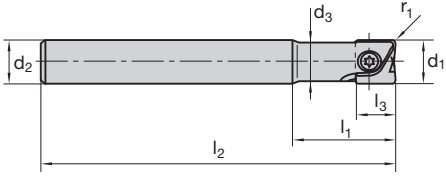

CN = Spanleitstufe für Nichteisenmetalle, Kunststoffe und Graphit
 CN = Chip Control Geometry for non-ferrous materials, plastics and graphite
 Alle WPR-, WPV- und WPB-Wendeplatten sind in der Sorte LC 610A
 (diamantbeschichtet) oder PKD/CBN-bestückt auf Anfrage lieferbar
 All WPR, WPV and WPP inserts are available in grade LC 610A
 (diamond coated) or PCD/CBN tipped

Sortenbeschreibung/-bezeichnung und ISO-Code ab Seite 22
 Description/Designation of grades and ISO-Code starting page 22

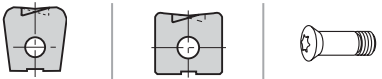
EBG V (GWV)



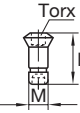

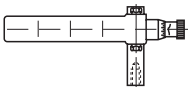
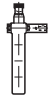

d ₁	l ₁	l ₂	d ₂	d ₃	z	LMT Code	Ident No.	Wendeplatten Inserts	Wendeplatten Inserts	Ident No.
8	27	102	8	7	2	EBG V08.008AN100-C (GWV 8 100 8-HM)	K130576	WPB 08	WPV 08	GWS 08 T8
8	42	152	8	7	2	EBG V08.008AN150-C (GWV 8 150 8-HM)	K130577			
10	37	122	10	8,8	2	EBG V10.010AN120-C (GWV 10 120 10-HM)	K130578	WPB 10	WPV 10	GWS 10 T15
10	52	152	10	8,8	2	EBG V10.010AN150-C (GWV 10 150 10-HM)	K130579			
12	37	122	12	10,5	2	EBG V12.012AN120-C (GWV 12 120 12-HM)	K128023	WPB 12	WPV 12	GWS 12 T20
12	52	162	12	10,5	2	EBG V12.012AN160-C (GWV 12 160 12-HM)	K128030			
16	42	142	16	14	2	EBG V16.016AN140-C (GWV 16 140 16-HM)	K128031	WPB 16	WPV 16	GWS 16 T20
16	57	177	16	14	2	EBG V16.016AN175-C (GWV 16 175 16-HM)	K128032			
20	52	142	20	18	2	EBG V20.020AN140-C (GWV 20 140 20-HM)	K128033	WPB 20	WPV 20	GWS 20 T20
20	77	192	20	18	2	EBG V20.020AN190-C (GWV 20 190 20-HM)	K128034			
25	62	162	25	22,4	2	EBG V25.025AN160-C (GWV 25 160 25-HM)	K128035	WPB 25	WPV 25	GWS 25 T30
25	92	212	25	22,4	2	EBG V25.025AN210-C (GWV 25 210 25-HM)	K128036			
32	67	192	32	28,6	2	EBG V32.032AN190-C (GWV 32 190 32-HM)	K128040		WPV 32	GWS 32 T30
32	107	242	32	28,6	2	EBG V32.032AN240-C (GWV 32 240 32-HM)	K128041			

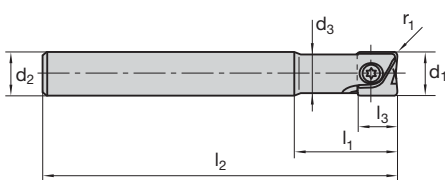

	LMT Code	Ident No.	L mm	Torx für Torx Schraubendreher for Torx screwdriver	Auszugsmomente (Nm) Torque (Nm)
 Befestigungsschraube für Wendeplatte Fixing Screw for inserts	GWS 08	K119572	6,9	T8	von Hand manual 6,0 6,0 – 6,5 6,0 – 6,5 6,5 6,5
	GWS 10	K119571	8,4	T10	
	GWS 12	K119559	9,1	T20	
	GWS 16	K119560	12,8		
	GWS 20	K119561	15,5		
	GWS 25	K119562	20,4	T30	
	GWS 32	K119563	24,8		
 Torx-Schraubendreher Torx screwdriver	T8	K119528			
	T15	K119529			
	T20	K119530			
	T30	K119533			
 Drehmomentschlüssel/Satz Torque spanner/set Einsätze (Ersatz) Bits (Spare)		K180043		Inhalt (je 1 Stück): Content (1 pc. each):	T20 T30 SW3
	T20	K119519			
	T30	K119520			

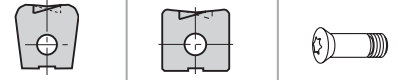
Wendeschneidplatten ab Seite 215
Indexable Inserts starting page 215

EBG V (GWV)



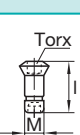
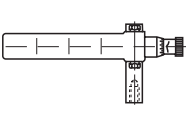
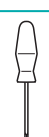



d ₁	l ₁	l ₂	d ₂	d ₃	z	LMT Code	Ident No.	Wendeplatten Inserts	Wendeplatten Inserts	Ident No.
12	34	92	12	10,5	2	EBG V12.012AN090 (GWV 12 90 12-RZ)	K130574	WPB 12	WPV 12	GWS 12 T20
12	34	132	12	10,5	2	EBG V12.012AN130 (GWV 12 130 12-RZ)	K121399			
12	48	152	12	10,5	2	EBG V12.012AN150 (GWV 12 150 12-RZ)	K121383			
16	38	102	16	14	2	EBG V16.016AN100 (GWV 16 80 12-RZ)	K130575	WPB 16	WPV 16	GWS 16 T20
16	38	142	16	14	2	EBG V16.016AN140 (GWV 16 140 16-RZ)	K121389			
16	55	162	16	14	2	EBGV16.016AN160 (GWV 16 160 16-RZ)	K121391	WPB 20	WPV 20	GWS 20 T20
20	47	162	20	18	2	EBG V20.020AN160 (GWV 20 160 20-RZ)	K121377	WPB 25	WPV 25	GWS 25 T30
20	63	177	20	18	2	EBG V20.020AN190 (GWV 20 175 20-RZ)	K121379			
25	47	162	25	22,4	2	EBG V25.024AN175 (GWV 25 160 25-RZ)	K121371			
25	72	192	25	22,4	2	EBG V25.025AN210 (GWV 25 190 25-RZ)	K121373		WPV 32	GWS 32 T30
32	58	177	32	28,6	2	EBG V32.032AN175 (GWV 32 175 32-RZ)	K121363			
32	82	212	32	28,6	2	EBG V32.032AN210 (GWV 32 210 32-RZ)	K121364			



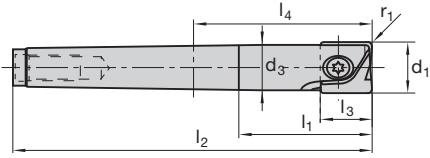

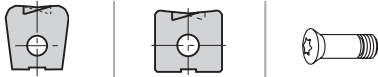
	LMT Code	Ident No.	L mm	Torx für Torx Schraubendreher for Torx screwdriver	Auszugsmomente (Nm) Torque (Nm)	
	Befestigungsschraube für Wendeplatte Fixing Screw for inserts	GWS 12	K119559	9,1	T 20	
		GWS 16	K119560	12,8		
		GWS 20	K119561	15,5		
		GWS 25	K119562	20,4	T 30	
		GWS 32	K119563	24,8		
	Torx-Schraubendreher Torx screwdriver	T 20	K119530			
		T 30	K119533			
	Drehmomentschlüssel/Satz Torque spanner/set Einsätze (Ersatz) Bits (Spare)		K180043	Inhalt (je 1 Stück): Content (1 pc. each):		T20
		T 20	K119519			T30
		T 30	K119520			SW3

Wendeschneidplatten ab Seite 215
Indexable Inserts starting page 215

EBG V (GWV)

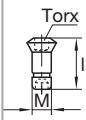
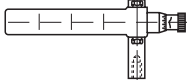





d ₁	l ₁	l ₂	MK	d ₃	l ₄	z	LMT Code	Ident No.	Wendeplatten Inserts	Wendeplatten Inserts	Ident No.
12	38	117	2	10,5	53	2	EBG V12.012M2115 (GWV 12 90 2-MK)	K121321	WPB 12	WPV 12	GWS 12 T20
12	55	132	2	10,5	68	2	EBG V12.012M2130 (GWV 12 130 2-MK)	K121322			
16	38	117	2	14	53	2	EBG V16.016M2115 (GWV 16 115 2-MK)	K121325	WPB 16	WPV 16	GWS 16 T20
16	55	132	2	14	68	2	EBG V16.016M2130 (GWV 16 130 2-MK)	K121326			
20	47	127	2	17,8	63	2	EBG V20.020M2125 (GWV 20 125 2-MK)	K121313	WPB 20	WPV 20	GWS 20 T20
20	63	142	2	17,8	78	2	EBG V20.020M2140 (GWV 20 140 2-MK)	K121314			
25	47	147	3	22,4	66	2	EBG V25.025M3145 (GWV 25 145 3-MK)	K121317	WPB 25	WPV 25	GWS 25 T30
25	72	172	3	22,4	91	2	EBG V25.025M3170 (GWV 25 170 3-MK)	K121318			
32	47	167	4	28,6	64,5	2	EBG V32.032M4165 (GWV 32 165 4-MK)	K121312	WPB 32	WPV 32	GWS 32 T30
32	72	192	4	28,6	89,5	2	EBG V32.032M4190 (GWV 32 190 4-MK)	K121302			

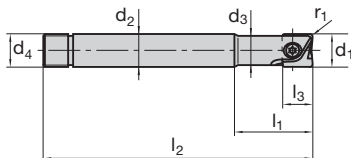

	LMT Code	Ident No.	L mm	Torx für Torx Schraubendreher for Torx screwdriver	Auszugsmomente (Nm) Torque (Nm)		
	Befestigungsschraube für Wendeplatte	GWS 12	K119559	T 20	6,0		
	Fixing Screw for inserts	GWS 16	K119560		12,8		6,0 – 6,5
		GWS 20	K119561		15,5		6,0 – 6,5
		GWS 25	K119562		20,4		6,5
		GWS 32	K119563	24,8	6,5		
	Torx-Schraubendreher	T 20	K119530	T 30			
	Torx screwdriver	T 30	K119533				
	Drehmomentschlüssel/Satz	K180043		Inhalt (je 1 Stück): Content (1 pc. each):	T20		
	Einsätze (Ersatz) Bits (Spare)	T 20	K119519		T30		
		T 30	K119520		SW3		

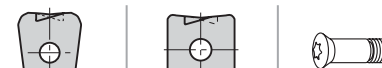
Wendeschneidplatten ab Seite 215
Indexable Inserts starting page 215

EBG V (GWV)



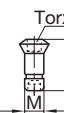
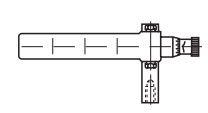

d ₁	l ₁	l ₂	d ₂	d ₃	d ₄	z	LMT Code	Ident No.	Wendeplatten Inserts	Wendeplatten Inserts	Ident No.
12	34	82	12	10,5	11,9	2	EBG V12.012DN080 (GWV 12 80 12-RS)	K121355	WPB 12	WPV 12	GWS 12 T20
12	48	102	12	10,5	11,9	2	EBG V12.012DN100 (GWV 12 100 12-RS)	K121338			
16	38	92	16	14	15,9	2	EBG V16.016DN090 (GWV 16 90 16-RS)	K121341	WPB 16	WPV 16	GWS 16 T20
16	55	112	16	14	15,9	2	EBG V16.016DN110 (GWV 16 110 16-RS)	K121342			
20	47	112	20	18	19,9	2	EBG V20.020DN110 (GWV 20 110 20-RS)	K121345	WPB 20	WPV 20	GWS 20 T20
20	63	127	20	18	19,9	2	EBG V20.020DN125 (GWV 20 125 20-RS)	K121346			
25	47	112	25	22,4	24,9	2	EBG V25.025DM110 (GWV 25 110 25-RS)	K121331	WPB 25	WPV 25	GWS 25 T30
25	72	142	25	22,4	24,9	2	EBG V25.025DN140 (GWV 25 140 25-RS)	K121332			
32	58	127	32	28,6	31,9	2	EBG V32.032DN125 (GWV 32 125 32-RS)	K121335		WPV 32	GWS 32 T30
32	82	162	32	28,6	31,9	2	EBG V32.032DN160 (GWV 32 160 32-RS)	K121336			

	LMT Code	Ident No.	L mm	Torx für Torx Schraubendreher for Torx screwdriver	Auszugsmomente (Nm) Torque (Nm)	
 Befestigungsschraube für Wendeplatte Fixing Screw for inserts	GWS 12	K119559	9,1	T 20	6,0	
	GWS 16	K119560	12,8		6,0 – 6,5	
	GWS 20	K119561	15,5		6,0 – 6,5	
	GWS 25	K119562	20,4	T 30	6,5	
	GWS 32	K119563	24,8		6,5	
 Torx-Schraubendreher Torx screwdriver	T 20	K119530				
	T 30	K119533				
 Drehmomentschlüssel/Satz Torque spanner/set		K180043		Inhalt (je 1 Stück): Content (1 pc. each):	T20	
	Einsätze (Ersatz) Bits (Spare)	T 20 T 30	K119519 K119520			T30 SW3

Wendeschneidplatten ab Seite 215
Indexable Inserts starting page 215

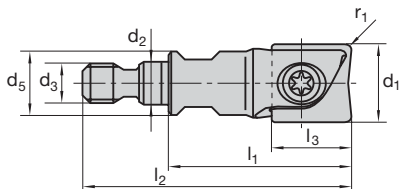
EBG V (GWV)



d ₁	l ₁	l ₂	d ₂	d ₃	d ₅	z	LMT Code	Ident No.	Wendeplatten Inserts	Wendeplatten Inserts	Ident No.
12	32	49,5	8,5	M 8	13	2	EBG V12.012TR032 (GWV 12 32 85-THR)	K128932	WPB 12	WPV 12	GWS 12 T20
16	37	54,5	8,5	M 8	13	2	EBG V16.016TR037 (GWV 16 37 85-THR)	K128934	WPB 16	WPV 16	GWS 16 T20
20	37	56,5	10,5	M 10	18	2	EBG V20.020TS037 (GWV 20 37 15-THR)	K128936	WPB 20	WPV 20	GWS 20 T20
25	42	64	12,5	M 12	21	2	EBG V25.025TF042 (GWV 25 42 12-THR)	K128937	WPB 25	WPV 25	GWS 25 T30

	LMT Code	Ident No.	L mm	Torx für Torx Schraubendreher for Torx screwdriver	Auszugsmomente (Nm) Torque (Nm)	
	Befestigungsschraube für Wendeplatte Fixing Screw for inserts	GWS 12	K119559	9,1	T 20 T 30	6,0
		GWS 16	K119560	12,8		6,0 – 6,5
		GWS 20	K119561	15,5		6,0 – 6,5
		GWS 25	K119562	20,4		6,5
		GWS 32	K119563	24,8		6,5
	Torx-Schraubendreher Torx screwdriver	T 20	K119530			
		T 30	K119533			
	Drehmomentschlüssel/Satz Torque spanner/set Einsätze (Ersatz) Bits (Spare)		K180043	Inhalt (je 1 Stück): Content (1 pc. each):		T20
		T 20	K119519			T30
		T 30	K119520			SW3

Wendeschneidplatten ab Seite 215
Indexable Inserts starting page 215

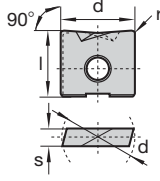
N = Anzahl der Schneidkanten N = Number of cutting edges						ISO-Code Cat-No.	Schneidstoffsorten Cutting materials Ident No.											Für Fräser For cutter Cat-No.								
	l	s	d	d ₁	r		LC225N	LC240N	LC240T	LC240S	LC230F	LC225T	LC225S	LC630T	LW240	LW225	LC440T		LC444W	LC610E	LC610T	LC610W	LC610A	LW610	LC603Z	
 N = 2	9,5	2	8		0,6	WPV 08-N		K122597	K127913					K122608												EBG V (GWV)
	11,5	2,5	10		0,8	WPV 10-N		K122671	K127912					K122682					K122595	K122596			K122594			
	14	2,5	12		1,0	WPV 12-N		K122649	K127331					K122672					K122665	K122648			K122664			
	16	3	16		1,3	WPV 16-N		K122643	K127310					K122650					K122641	K122642			K122640			
	18	3	20		1,6	WPV 20-N		K122637	K127657					K122644					K122635	K122636			K122634			
	23,5	4	25		2,0	WPV 25-N		K122613	K127914					K122638					K122629	K122612			K122628			
	28	5	32		2,5	WPV 32-N		K122607	K127656					K122614					K122605	K122606			K122620			

Alle WPR-, WPV- und WPB-Wendeplatten sind in der Sorte LC 610A (diamantbeschichtet) oder PKD/CBN-bestückt auf Anfrage lieferbar
All WPR, WPV and WPP inserts are available in grade LC 610A (diamond coated) or PCD/CBN tipped

Sortenbeschreibung/-bezeichnung und ISO-Code ab Seite 22
Description/Designation of grades and ISO-Code starting page 22

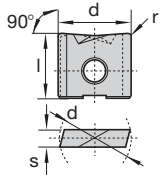
N = Anzahl der Schneidkanten N = Number of cutting edges						ISO-Code Cat-No.	Schneidstoffsorten Cutting materials Ident No.												Für Fräser For cutter Cat-No.						
	l	s	d	d ₁	r		LC225N	LC240N	LC240T	LC240S	LC230F	LC225T	LC225S	LC630T	LW240	LW225	LC440T	LC444W		LC610E	LC610T	LC610W	LC610A	LW610	LC603Z
 N = 2	9,5	2	8		0,6	WPV 08-N-CF		K122537	K282725											K122544	K122545		K122543		EBG V (GWV)
	11,5	2,5	10		0,8	WPV 10-N-CF		K122569	K282727											K122587	K122588		K122586		
	14	2,5	12		1,0	WPV 12-N-CF		K122582	K282729											K122580	K122581		K122579		
	16	3	16		1,3	WPV 16-N-CF		K122575	K282731											K122573	K122574		K122572		
	18	3	20		1,6	WPV 20-N-CF		K122568	K282733											K122566	K122567		K122565		
	23,5	4	25		2,0	WPV 25-N-CF		K122561	K282735											K122559	K122560		K122558		
	28	5	32		2,5	WPV 32-N-CF		K122553	K282737											K122551	K122552		K122550		

CF = Spanleitstufe für langspanende Eisenwerkstoffe
 CF = Chip Control Geometry for longchipping ferrous materials
 Alle WPR-, WPV- und WPB-Wendeplatten sind in der Sorte LC 610A
 (diamantbeschichtet) oder PKD/CBN-bestückt auf Anfrage lieferbar
 All WPR, WPV and WPP inserts are available in grade LC 610A
 (diamond coated) or PCD/CBN tipped

Sortenbeschreibung/-bezeichnung und ISO-Code ab Seite 22
 Description/Designation of grades and ISO-Code starting page 22

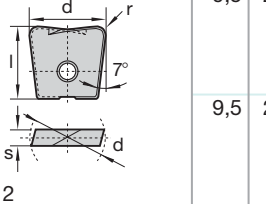
N = Anzahl der Schneidkanten N = Number of cutting edges						ISO-Code Cat-No.	Schneidstoffsorten Cutting materials Ident No.											Für Fräser For cutter Cat-No.						
	l	s	d	d ₁	r		LC240T	LC240S	LC230F	LC225T	LC225S	LC630T	LW240	LW225	LC440T	LC444W	LC610E		LC610T	LC610W	LC610A	LW610	LC603Z	
 <p>N = 2</p>	9,5	2	8		0,6	WPB 08-N-06											K282927						K282921	EBG V (GWV)
	9,5	2	8		1,0	WPB 08-N-10											K282919						K282916	
	11,5	2,5	10		0,8	WPB 10-N-08											K282928						K282922	
	11,5	2,5	10		1,0	WPB 10-N-10											K282918						K282917	
	14	2,5	12		1,0	WPB 12-N-10											K129227						K129226	
	14	2,5	12		2,0	WPB 12-N-20											K128106						K128105	
	16	3	16		1,0	WPB 16-N-10											K129229						K129228	
	16	3	16		1,3	WPB 16-N-13											K282931						K282923	
	16	3	16		3,0	WPB 16-N-30											K128110						K128109	

Alle WPR-, WPV- und WPB-Wendeplatten sind in der Sorte LC 610A (diamantbeschichtet) oder PKD/CBN-bestückt auf Anfrage lieferbar
All WPR, WPV and WPP inserts are available in grade LC 610A (diamond coated) or PCD/CBN tipped

Sortenbeschreibung/-bezeichnung und ISO-Code ab Seite 22
Description/Designation of grades and ISO-Code starting page 22

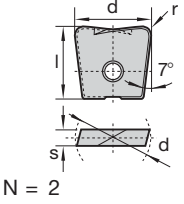
N = Anzahl der Schneidkanten N = Number of cutting edges						ISO-Code Cat-No.	Schneidstoffsorten Cutting materials Ident No.											Für Fräser For cutter Cat-No.								
	l	s	d	d ₁	r		LC240T	LC240S	LC230F	LC225T	LC225S	LC630T	LW240	LW225	LC440T	LC444W	LC610E		LC610T	LC610W	LC610A	LW610	LC603Z			
 <p>N = 2</p>	18	3	20		1,0	WPB 20-N-10																	EBG (GWV)			
	18	3	20		1,6	WPB 20-N-16											K129231				K129230					
	18	3	20		4,0	WPB 20-N-40												K282930				K282924				
	18	3	20		4,0	WPB 20-N-40												K128114				K128113				
	23,5	4	25		1,0	WPB 25-N-10													K129233					K129232		
	23,5	4	25		2,0	WPB 25-N-20														K282929					K282926	
	23,5	4	25		5,0	WPB 25-N-50														K128118					K128117	

Alle WPR-, WPV- und WPB-Wendeplatten sind in der Sorte LC 610A (diamantbeschichtet) oder PKD/CBN-bestückt auf Anfrage lieferbar
All WPR, WPV and WPP inserts are available in grade LC 610A (diamond coated) or PCD/CBN tipped

Sortenbeschreibung/-bezeichnung und ISO-Code ab Seite 22
Description/Designation of grades and ISO-Code starting page 22

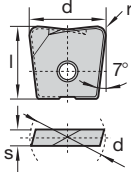
N = Anzahl der Schneidkanten N = Number of cutting edges						ISO-Code Cat-No.	Schneidstoffsorten Cutting materials Ident No.											Für Fräser For cutter Cat-No.					
	l	s	d	d ₁	r		LC240T	LC240S	LC230F	LC225T	LC225S	LC630T	LW240	LW225	LC440T	LC444W	LC610E		LC610T	LC610W	LC610A	LW610	LC603Z
 <p>N = 2</p>	8	1,6	6		0,5	WPB 06-N-05-CF												K129235		K282824	K129234		EBG V (GWV)
	9,5	2	8		1,0	WPB 08-N-10-CF												K129237		K282825	K129236		
	11,5	2,5	10		1,0	WPB 10-N-10-CF												K129239		K282826	K129238		
	14	2,5	12		1,0	WPB 12-N-10-CF												K282913		K282827	K282909		
	14	2,5	12		2,0	WPB 12-N-20-CF												K128108			K128107		
	16	3	16		1,0	WPB 16-N-10-CF												K282914		K282828	K282910		
	16	3	16		3,0	WPB 16-N-30-CF												K128112			K128111		
	18	3	20		1,0	WPB 20-N-10-CF												K129258			K282911		
	18	3	20		4,0	WPB 20-N-40-CF												K128116			K128115		
	23,5	4	25		1,0	WPB 25-N-10-CF												K282916			K282912		
	23,5	4	25		5,0	WPB 25-N-50-CF												K128120			K128119		

Alle WPR-, WPV- und WPB-Wendeplatten sind in der Sorte LC 610A (diamantbeschichtet) oder PKD/CBN-bestückt auf Anfrage lieferbar
All WPR, WPV and WPP inserts are available in grade LC 610A (diamond coated) or PCD/CBN tipped

Sortenbeschreibung/-bezeichnung und ISO-Code ab Seite 22
Description/Designation of grades and ISO-Code starting page 22

Werkstoff	Material	R _m /UTS (N/mm ²)	HM-Sorten Carbide Grade	Schnittgeschwindigkeit Cutting speed v _c = m/min			
				Schruppen Roughing		Schlichten Finishing	
				mit Rundpl. with round inserts	m. Schaftschrupp- oder Kugelstirnfäser with Roughing End Mills or Ball Nose Cutters		mit Cermet with Cermet
Unlegierter Baustahl	Plain carbon steel	- 700	LC240T	300 - 250	200 - 160	300 - 250	350 - 300
Automatenstahl	Free cutting steel	- 700	LC610T	300 - 250	200 - 160	300 - 250	350 - 300
Baustahl	Structural alloy steel	500 - 950	(Schlichten Finishing)	300 - 250	200 - 160	300 - 250	350 - 300
Vergütungsstahl, mittelfest	Heat-treatable steel, medium strength	500 - 950		300 - 250	200 - 160	300 - 250	350 - 300
Stahlguss	Cast steel	- 950		300 - 250	200 - 160	300 - 250	350 - 300
Einsatzstahl	Case hardening steel	- 950		300 - 250	200 - 160	300 - 250	350 - 300
Rost- und säurebe- ständiger Stahl, ferri- tisch, martensitisch	Stainless steel, ferritic, martensitic	500 - 950		300 - 250	200 - 160	300 - 250	350 - 300
Vergütungsstahl, hochfest	Heat-treatable steel, high strength	950 - 1400	LC240T LC610T	220 - 180	150 - 120	220 - 180	250 - 200
Nitrierstahl, vergütet	Nitriding steel	950 - 1400	(Schlichten	220 - 180	150 - 120	220 - 180	250 - 200
Werkzeugstahl	Tool steel	950 - 1400	Finishing)	220 - 180	150 - 120	220 - 180	250 - 200
Rost- und säurebe- ständiger Stahl, austenitisch	Stainless steel, austenitic		500 - 950	LC240T (-80) ³⁾	250 - 350	250 - 350 (-80) ³⁾	250
Martensitaushärt- barer Stahl	Maraging steel			250 - 350 (-80) ³⁾		250 - 350 (-80) ³⁾	
Grauguss	Grey cast iron	100 - 400 (120 - 260 HB)	LC610T	300 - 200	300 - 200	350 - 250	300 - 250
Legierter Grauguss	Alloyed grey cast iron	150 - 250 (100 - 230 HB)	LC610T	300 - 200	300 - 200	350 - 250	300 - 250
Sphäroguss	Nodular cast iron	400 - 800 (120 - 310 HB)	LC610T	300 - 200	300 - 200	350 - 250	300 - 250
Temperguss	Malleable cast iron	350 - 700 (150 - 280 HB)	LC610T	300 - 200	300 - 200	350 - 250	300 - 250
Rein-Metalle, weich	Pure metals, soft	- 500	LC225S	300 - 1000	300 - 1000	500 - 1500	
Aluminium-Legierun- gen, langspanend	Aluminium alloys, long chipping	- 550	LW610 ¹⁾	300 - 1000	300 - 1000	500 - 1500	
Aluminium-Legierun- gen, kurzspanend	Aluminium alloys, short chipping	- 400	LW610 ¹⁾	300 - 200	300 - 200	350 - 250	300 - 250
Kupfer-Legierungen, langspanend	Copper alloys, long chipping	300 - 700	LC225S	300 - 1000	300 - 1000	500 - 1500	
Kupfer-Legierungen, kurzspanend	Copper alloys, short chipping	- 500	LC225S	300 - 200	300 - 200	350 - 250	300 - 250
Magnesium-Legie- rungen	Magnesium alloys	150 - 300	LW610 ¹⁾	300 - 1000	300 - 1000	500 - 1500	
Thermoplaste	Thermoplastics	40 - 70	LW610 ¹⁾	300 - 1000	300 - 1000	500 - 1500	
Duroplaste	Duroplastics	20 - 40	LW610 ¹⁾	300 - 200	300 - 200	350 - 250	300 - 250
Graphit	Graphite						
Titan-Legierungen, mittelfest	Titanium alloys, medium strength	- 950	LW610 ¹⁾	40 - 80	40 - 80	40 - 80	
Titan-Legierungen, hochfest	Titanium alloys, high strength	900 - 1400	LW610 ¹⁾	40 - 80	40 - 80	40 - 80	
Nickelbasis-Legie- rungen, mittelfest	Nickel based alloys, medium strength	- 950	LC225S	40 - 80	40 - 80	40 - 80	
Hochwarmfeste Nickel-Basis- Legierungen	Heat resistant nickel based alloys, high strength	900 - 1400	LC225S	40 - 80	40 - 80	40 - 80	
Hartguss	Chilled cast iron	300 - 600 HB	LC240T	40 - 80	40 - 80	40 - 80	

¹⁾ Unbeschichtete HM-Sorte, v_c-Wert der Tabelle ist gültig für diese Sorte

¹⁾ Uncoated grade, value of v_c is valid for this grade

³⁾ Bei Verwendung von Kühlschmierstoffen



³⁾ When using liquid coolants.



Beim Einsatz unbeschichteter Sorten Schnittgeschwindigkeit um 30 % reduzieren. When using uncoated grades reduce cutting speed by 30 %.



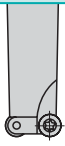
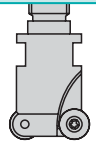

Technische Hinweise Technical hints

Empfohlene maximale Zahnvorschübe f_z (mm) für Kopierfräser Recommended maximum feed per tooth f_z (mm) for Copy Milling Cutters

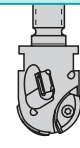
Zahnvorschub und Spantiefe sind abhängig von Werkzeug- \emptyset , WP- \emptyset und Ausspannlänge!
Feed per tooth and depth of cut tool-dia., indexable insert dia. and unclamped length!

Cat.-No.	FCZ			FCT			ECZ				
											
\emptyset mm	42 – 80			42 – 125			8 – 40				
ISO-Code	RDHW RDHX			RCHX			RDHW RDHX				
WP- \emptyset	10	12	16	10	12	16	5	7	8	10	12
max. ap	2,5	3	5	2,5	3	5	0,8	1,5	2	3	3,5
	0,25	0,3 – 0,4	0,4 – 0,45	0,25	0,3 – 0,4	0,4 – 0,45	0,25 – 0,3	0,27 – 0,3	0,3 – 0,35	0,22 – 0,37	0,3 – 0,4
	0,12	0,15	0,2	0,12	0,15	0,2	0,08	0,1	0,12	0,12	0,15
	0,25	0,35	0,35	0,25	0,35	0,35	0,2	0,2	0,25	0,3	0,35
	0,3	0,4	0,4	0,3	0,4	0,4	0,25	0,25	0,3	0,35	0,4
	0,25	0,3	0,3	0,25	0,3	0,3	0,15	0,15	0,2	0,25	0,3

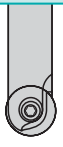
Cat.-No.	ECT				EBG T GRT	EBT			
									
\emptyset mm	10 – 40				25 – 32	20 – 50			
ISO-Code	RCHX					CCMT SNKX			
WP- \emptyset	5	8	10	12		6,35	7,94	9,52	12,7
max. ap	0,8	2	3	3,5					
	0,25 – 0,35	0,3 – 0,35	0,22 – 0,25	0,3	0,2 – 0,25	0,2	0,25	0,3	0,35
	0,1	0,12	0,12	0,15					
	0,3	0,25	0,3	0,35	0,3	0,2	0,25	0,3	0,35
	0,35	0,3	0,35	0,4	0,4	0,25	0,3	0,35	0,4
	0,25	0,2	0,25	0,3	0,25	0,15	0,2	0,25	0,3

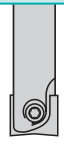
Cat.-No.	EBT				EBG R GWR	EBG R THR	EBG V GWV				
											
\emptyset mm	16 – 32				6 – 32		12 – 32				
ISO-Code											
Wkz- \emptyset	16	20	25	32	8	10	12	16	20	25	32
max. ap	1,5	2	2,5	3	1	1	1	1,5	2	2,5	3
	0,15	0,2	0,2	0,25	0,15	0,15	0,15	0,15	0,2	0,2	0,2 – 0,25
	0,08	0,1	0,08	0,1	0,08	0,08	0,08	0,08	0,1	0,1	0,12
	0,12	0,16	0,2	0,25	0,1	0,1	0,1	0,12	0,16	0,2	0,25
	0,15	0,2	0,25	0,3	0,1	0,1	0,1	0,15	0,2	0,25	0,3
	0,12	0,16	0,18	0,2	0,1	0,1	0,1	0,12	0,16	0,18	0,2

Werkstoff	Material		Schnittgeschwindigkeit Cutting Speed	
			LC610T v_c (m/min)	LW610 v_c (m/min)
Aluminium-Legierungen,	Aluminium alloys,	$R_m < 280 \text{ N/mm}^2$	1500	1000
		$R_m < 280 \text{ N/mm}^2$	1000	800
Kupfer-Legierungen,	Copper alloys,	langspanend long chipping	300	250
Thermoplaste	Thermoplastics			300
Aluminium-Legierungen,	Aluminium alloys,	$Si < 12\%$	100	800
		$Si \geq 12\%$ ¹⁾	200	
Kupfer-Legierungen,	Copper alloys,	kurz spanend short chipping	500	400
Magnesium-Legierungen	Magnesium alloys			400
Duroplaste	Duroplastics		200	150

Maximale Vorschübe pro Zahn maximum feed per tooth f_z (mm/z) in mm		
VPGT1103..	VPGT1604..	VCGT2205..
0,25	0,35	0,5
0,2	0,3	0,4

Weitere Anwendungsempfehlungen Further application recommendations

Tauchfräsen und axiales Eintauchen Pocket milling and axial plunging		Schrägungswinkel $W_{1 \max}$ und innere Schnitttiefe T_{\max} Helix angle $W_{1 \max}$ and internal depth of cut T_{\max}		
		VPGT 110304-ALM	VPGT 160412-ALM	VCGT 220530-ALM
$a_{p \max}$		10	13,5	15
T_{\max}		6	8	9
		$W_{1 \max}$ in Grad Degree		
		25		
			24	
				22
				15
				12
				9
				7
				5
				4

Zirkularfräsen Circular milling		d_1 mm	d_{\min} mm	d_{\max} mm
		20	25	39,2
		25	35	47,6
		32	42	58
		42	62	78
		52	82	98
		66	110	126
		80	138	154
		100	178	194
		125	228	244

Werkstoff	Material	Werkstoff-Nr. Material No.	DIN Bez. DIN Des.	Vorschub pro Zahn Feed per tooth $f_z = \text{mm/z}$ Schnittgeschwindigkeit Cutting speed $v_c = \text{m/min}$			
				LC280TT		LC610T	
				v_c	f_z	v_c	f_z
Unlegierter Baustahl Vergütbare Formenstähle Einsatzstähle Durchhärtende Werkzeugstähle Nitrierstähle	Plain carbon steel	1.1730	C45W	300	2,5	330	2,2
		1.1545	C105W	300	2,5	330	2,2
	Heat-treatable die steels	1.2311	40CrMMo7	240	2,0	300	1,8
		1.2312	40CrMnNiMoS8.6.	240	2,0	300	1,8
		1.2738	45CrMnNiMo8.6.4	240	2,0	300	1,8
		1.2711	54NiCrMoV6	220	2,0	265	1,8
	Case hardening steels	1.2162	21MnCr5	300	2,0	330	1,8
		1.2764	X19NiCrMo4	240	2,0	306	1,8
	Full hardening tools steels	1.2343	X38CrMoV5.1	220	2,0	265	1,8
		1.2344	X40CrMoV5.1	220	2,0	265	1,8
		1.2367	X38CrMoV5.3	220	2,0	265	1,8
		1.2080	X210Cr12	200	1,8	250	1,6
		1.2379	X155CrVMo12.1	200	1,8	250	1,6
		1.2767	X45NiCrMo4	180	1,5	220	1,3
		1.2842	90MnCrV8	220	2,0	265	1,8
	Nitriding steels	1.8550	34CrAlNi7	180	2,0	220	1,8
		1.8519	31CrMoV9	180	1,5	220	1,3
		1.7735	14CrMoV6.9	180	1,5	220	1,3
1.2344		X40CrMoV5.1	150	2,0	200	1,8	
Rost- und säurebe- ständiger Stahl, austenitisch	Stainless steel, austenitic	1.2083	X42CrMo13	230	1,5	260	1,3
		1.2316	X36CrMo17	230	1,5	260	1,3
Grauguss und legierter Grauguss Kugelgraphitguss und legierter Kugelgraphit- guss	Grey cast iron and alloyed grey cast iron Nodular cast iron and alloyed nodular cast iron	0.6025	GG25	250	3,0	300	2,5
			GG25CrMoV	250	2,8	300	2,5
		0.7040	GGG40	200	2,0	250	1,8
		0.7070	GGG70	180	2,0	250	1,8
Gehärteter Stahl	Hardened steel	45-52HRC				120	0,5
		53-59HRC				100	0,5
		60-65HRC				90	0,5

Die angegebenen Schnittwerte sind Startwerte und müssen auf die vorhandenen Bedingungen abgestimmt werden
The cutting data indicated are starting values and must be adjusted to the prevailing conditions

Vorschub-Korrektur Feed Correction		
f_z		
$v_f = n \cdot z \cdot f_z \cdot f_2$		
a_p	$l_{ges} = \max. 4 \times d_1$	$l_{ges} = > 4 \times d_1$
0,5	1,3	1,0
1,0	1,0	0,75
1,5	0,7	0,5

Tauchfräsen Plunge milling		
d_1	Schrittweite Step over mm	f_2 in mm
20	2	0,1
25	2	0,1
30	3	0,1
32	4	0,15
35	5	0,2
42	5	0,2
52	5	0,2
66	5	0,2

v_f = Vorschubgeschwindigkeit in mm Feed rate in mm	Beispiel Example
n = Drehzahl in min^{-1} Revolutions in min^{-1}	Material: 1.2312
z = Anzahl der Schneiden No. of teeth	$l_{ges} = 5 \cdot d_1$
v_z = Vorschub pro Zahn in mm Feed per tooth in mm	$n = 2.400 \text{ min}^{-1}$
l_{ges} = Ausspannlänge Reach	$z = 3$
a_p = Axiale Schnitttiefe in mm Depth of cut in mm	$a_p = 1$
	$f_z = 2 \text{ mm für LC280TT}$
	$f_2 = 0,75$
	$v_f = 2.400 \cdot 3 \cdot 2 \cdot 0,75$ $= 10.800 \text{ mm/min}$

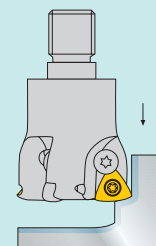



Scheibenfräser und Trennfräser

Side Milling Cutters

Auswahlübersicht Selection table	227
Scheibenfräser, schmal Side Milling Cutters, narrow	228
Schnittwertempfehlungen Cutting data recommendations	232

Scheibenfräser und Trennfräser Side Milling Cutters

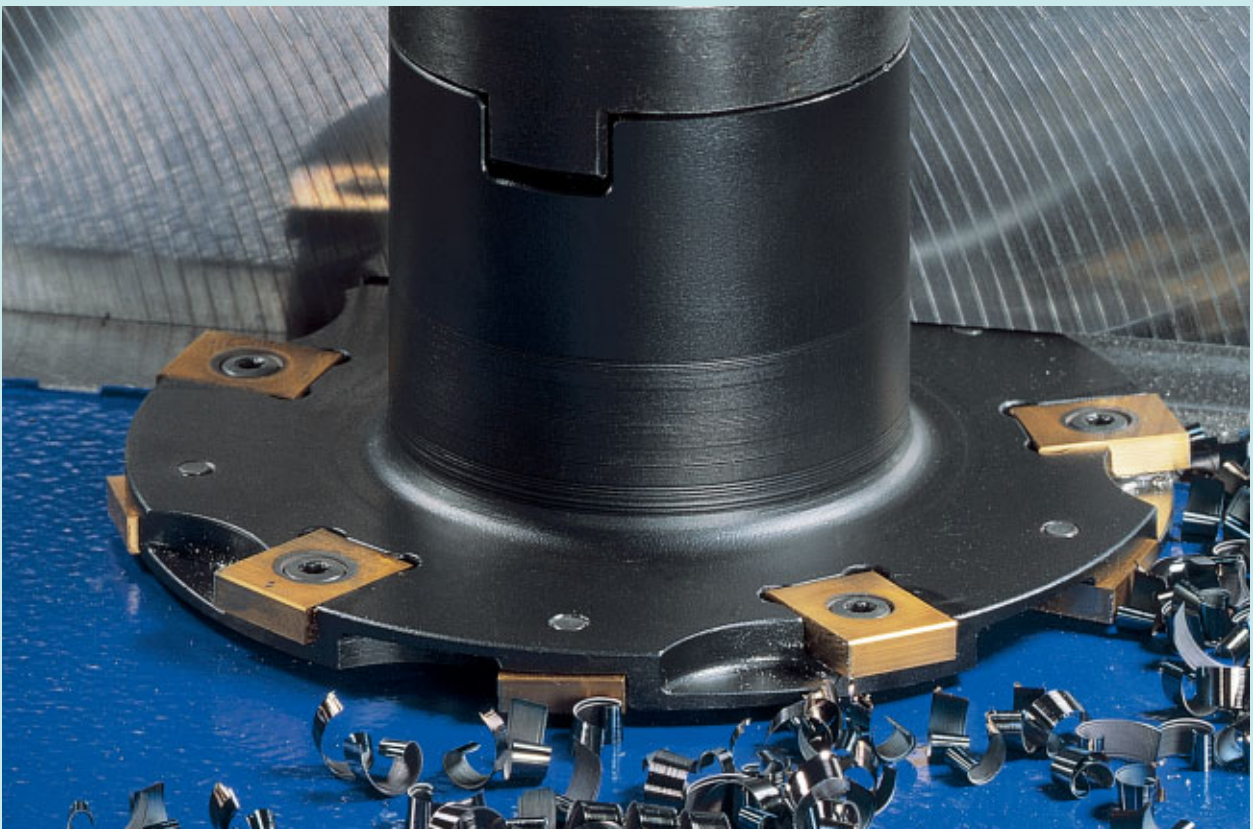

Auswahlübersicht Selection table

Scheibenfräser mit Tangential-Wendeplatten Side Milling Cutters with tangential Indexable Inserts

	Kat.-Nr. Cat.-No.			Nenn- ϕ Nominal- ϕ	Seite Page
	SMN90 1103	kreuzverzahnt staggered tooth Schneidenbreite Cutting width $b_1 = 5 - 10 \text{ mm}$	 tangential	80 – 200	229
	SMN90 11035	kreuzverzahnt staggered tooth Schneidenbreite Cutting width $b_1 = 6 - 10 \text{ mm}$	 tangential	63 – 160	229

Besondere Merkmale:

- Zum Nutenfräsen, Trennen und Schlitzen
- Stabile tangential angeordnete Wendeplatten, die voll im Grundkörper eingelassen sind
- Hohe Rund- und Planlaufgenauigkeit
- Kat.-Nr. 1103 als Satzfräser und im Paket einsetzbar

Special features:

- For side and face milling, slitting and grooving
- Tangentially arranged inserts, embedded in the basic cutter body
- Excellent true run
- Cat.-No. 1103 can also be used as a gang milling cutter

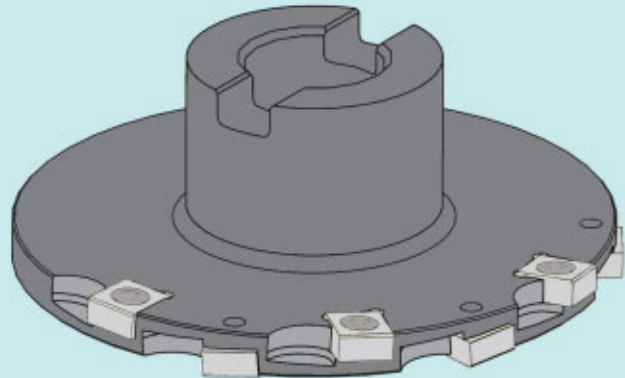

N = Anzahl der Schneidkanten N = Number of cutting edges							Schneidstoffsorten Cutting materials											Für Fräser For cutter						
							Ident No.																	
	l	s	d	d ₁	b/r	ISO-Code Cat-No.	LC240T	LC240S	LC230F	LC225T	LC225S	LC630T	LW240	LW225	LC440T	LC444W	LC610E	LC610T	LC610W	LC610A	LW610	LC603Z	Cat-No.	
<p>N = 4</p>	14,29	2,8	11,11	4,5	0,25	LNHX 1402 1185-50				1061285				1061284										SMN90
	14,29	3,3	11,11	4,5	0,3	LNHX 1403 1185-51				1061286	2275464			1061300								1061293		
	14,29	4,3	11,11	4,5	0,4	LNHX 1404 1185-52				1061287	2275582			1061328								1061319		
	14,29	5,3	11,11	4,5	0,5	LNHX 1405 1185-53				1061288				1061346								1061337		
<p>N = 4</p>	14,29	2,8	11,11	4,5	0,25	LNHX 1402 1185-55				1061297				1061382										SMN90
	14,29	3,3	11,11	4,5	0,3	LNHX 1403 1185-56				1061290	1061296			1061408								1061391		
	14,29	4,3	11,11	4,5	0,4	LNHX 1404 1185-57				1061291	1061295			1061426								1061417		
	14,29	5,3	11,11	4,5	0,5	LNHX 1405 1185-58				1061292				1061444								1061435		

Sortenbeschreibung/-bezeichnung und ISO-Code ab Seite 22
Description/Designation of grades and ISO-Code starting page 22

SMN90 1103

d ₁	b ₁	d ₂	d ₃	b ₂	a	z	Ident No.	LMT-Code		Ident No.	Ident No.	Ident No.
80	5	27	40	8	18	8	1024609	SMN90 L14.080AN05	LNHX 1402 1185-50	1045819	1045793	1048433
100	5	32	50	8	23	10	1024618	SMN90 L14.100AN05				
125	5	40	60	8	30,5	12	1024627	SMN90 L14.125AN05				
80	6	27	40	8	18	8	1024636	SMN90 L14.080AN06	LNHX 1403 1185-51	1045828	1045800	
100	6	32	50	10	23	10	1024645	SMN90 L14.100AN06				
125	6	40	60	10	30,5	12	1024654	SMN90 L14.125AN06				
80	8	27	40	10	18	8	1024663	SMN90 L14.080AN08	LNHX 1404 1185-52	1051277	1045034	1048335
100	8	32	50	10	23	10	1024672	SMN90 L14.100AN08				
125	8	40	60	12	30,5	12	1024681	SMN90 L14.125AN08				
160	8	40	60	12	48	16	1024690	SMN90 L14.160AN08				
200	8	50	75	14	60,5	18	1024707	SMN90 L14.200AN08				
80	10	27	40	12	18	8	1024716	SMN90 L14.080AN10				
100	10	32	50	12	23	10	1024725	SMN90 L14.100AN10	LNHX 1405 1185-53	1045105		
125	10	40	60	14	30,5	12	1024734	SMN90 L14.125AN10				
160	10	40	60	14	48	16	1024743	SMN90 L14.160AN10				
200	10	50	75	16	60,5	18	1024752	SMN90 L14.200AN10				

SMN90 11035

d ₁	b ₁	d ₂	d ₃	b ₂	a	z	Ident No.	LMT-Code		Ident No.	Ident No.	Ident No.
63	6	16	29	32	13	6	1024925	SMN90 L14.063AN06F	LNHX 1403 1185-51	1045828	1048433	
80	6	22	40	36	16	8	1024927	SMN90 L14.080AN06F				
100	6	27	48	45	22	10	1024929	SMN90 L14.100AN06F				
125	6	32	58	50	30	12	1024931	SMN90 L14.125AN06F				
160	6	40	70	63	41	16	1024933	SMN90 L14.160AN06F				
63	8	16	29	32	13	6	1024935	SMN90 L14.063AN08F				
80	8	22	40	36	16	8	1024937	SMN90 L14.080AN08F	LNHX 1404 1185-52	1044981	1048335	
100	8	27	48	45	22	10	1024939	SMN90 L14.100AN08F				
125	8	32	58	50	30	12	1024941	SMN90 L14.125AN08F				
160	8	40	70	63	41	16	1024943	SMN90 L14.160AN08F	LNHX 1405 1185-53	1045105		
100	10	27	48	45	22	10	1024949	SMN90 L14.100AN10F				
125	10	32	58	50	30	12	1024951	SMN90 L14.125AN10F				
160	10	40	70	63	41	16	1024953	SMN90 L14.160AN10F				

Werkstoff	Material	R _m /UTS (N/mm ²)	HM-Sorten Carbide Grade	Schnittgeschwindigkeit Cutting speed v _c = m/min	Eingriffsgröße $\frac{a_e}{d_1}$ Engagement value			
					0,3	0,2	0,1	0,05
					Vorschub pro Zahn Feed per tooth f _z			
Unlegierter Baustahl	Plain carbon steel	- 700	LC225S	200	0,32	0,4	0,56	0,8
Automatenstahl	Free cutting steel	- 700	LC225S	200	0,32	0,4	0,56	0,8
Baustahl	Structural alloy steel	500 – 950	LC225S	160	0,25	0,32	0,45	0,64
Vergütungsstahl, mittelfest	Heat-treatable steel, medium strength	500 – 950	LC225S	100	0,2	0,25	0,35	0,5
Stahlguss	Cast steel	- 950	LC225S	160	0,25	0,32	0,45	0,64
Einsatzstahl	Case hardening steel	- 950	LC225S	120	0,2	0,25	0,35	0,5
Rost- und säurebeständiger Stahl, ferritisch, martensitisch	Stainless steel, ferritic, martensitic	500 – 950	LC225S	100	0,2	0,25	0,35	0,5
Vergütungsstahl, hochfest	Heat-treatable steel, high strength	950 – 1400	LC225S	90	0,16	0,2	0,28	0,4
Nitrierstahl, vergütet	Nitriding steel	950 – 1400	LC225S	90	0,16	0,2	0,28	0,4
Werkzeugstahl	Tool steel	950 – 1400	LC225S	90	0,16	0,2	0,28	0,4
Rost- und säurebeständiger Stahl, austenitisch	Stainless steel, austenitic	500 – 950	LC225S	200 (80) ³⁾	0,1	0,15	0,2	0,25
Martensitaushärtbarer Stahl	Maraging steel							
Grauguss	Grey cast iron	100 – 400 (100 – 260 HB)	LC225S ²⁾	140	0,32	0,4	0,56	0,8
Legierter Grauguss	Alloyed grey cast iron	150 – 300 (100 – 230 HB)	LC225S ²⁾	80	0,25	0,32	0,45	0,64
Sphäroguss	Nodular cast iron	400 – 800 (120 – 310 HB)	LC225S ²⁾	80	0,2	0,25	0,35	0,5
Temperguss	Malleable cast iron	350 – 700 (150 – 280 HB)	LC225S ²⁾	100	0,2	0,25	0,35	0,5
Rein-Metalle, weich	Pure metals, soft	- 500	LC225S	250	0,25	0,3	0,4	0,5
Aluminium-Legierungen, langspanend	Aluminium alloys, long chipping	- 550	LW610 ¹⁾	900	0,4	0,5	0,7	1,0
Aluminium-Legierungen, kurzspanend	Aluminium alloys, short chipping	- 400	LW610 ¹⁾	300	0,32	0,4	0,56	0,8
Kupfer-Legierungen, langspanend	Copper alloys, long chipping	300 – 700	LC225S	250	0,25	0,32	0,45	0,64
Kupfer-Legierungen, kurzspanend	Copper alloys, short chipping	- 500	LC225S	250	0,25	0,32	0,45	0,64
Magnesium-Legierungen	Magnesium alloys	160 – 330	LW610 ¹⁾	400	0,3	0,4	0,55	0,7
Thermoplaste	Thermoplastics	40 – 70	LW610 ¹⁾	200	0,25	0,3	0,4	0,5
Duroplaste	Duroplastics	20 – 40	LW610 ¹⁾	150	0,2	0,25	0,35	0,5
Titan-Legierungen, mittelfest	Titanium alloys, medium strength	- 950	LW610 ¹⁾	80	0,16	0,2	0,28	0,4
Titan-Legierungen, hochfest	Titanium alloys, high strength	900 – 1400	LW610 ¹⁾	50	0,12	0,15	0,21	0,3
Nickelbasis-Legierungen, mittelfest	Nickel based alloys, medium strength	- 950	LC225S	60	0,16	0,2	0,28	0,4
Hochwarmfeste	Heat resistant	900 – 1400	LC225S	40	0,1	0,12	0,18	0,25
Nickel-Basis-Legierungen	nickel based alloys, high strength							
Hartguss	Chilled cast iron	300 – 600 HB	LC225S	40	0,2	0,25	0,35	0,5

¹⁾ Unbeschichtete HM-Sorte, v_c-Wert der Tabelle ist gültig für diese Sorte Uncoated grade, value of v_c is valid for this grade

²⁾ Alternativ LW610 (unbeschichtet) verwenden, dann v_c-Wert um 30 % reduzieren Use alternatively LW610 (uncoated) and reduce v_c by 30 %

³⁾ Bei Verwendung von Kühlschmierstoffen When using liquid coolants

Technische Hinweise Technical hints

Dreiseitig schneidend Three side cutting

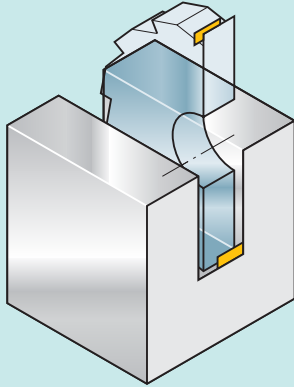

Cat.-No.	Z _{eff.}
SMN90	Z/2

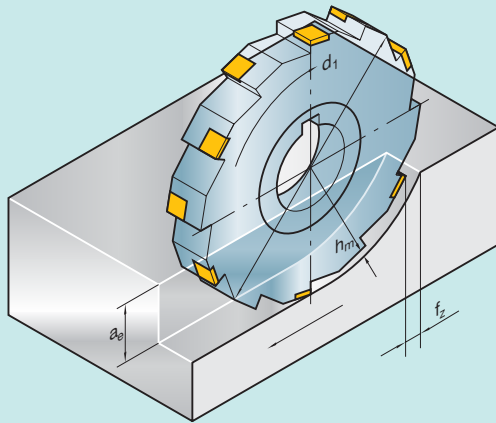

Beziehung zwischen Mittenspanndicke h_m
und Vorschub pro Zahn f_z

Relationship between mean chip thickness h_m
and feed per tooth f_z

$$h_m = f_z \cdot \sqrt{\frac{a_e}{d_1}}$$

Möglichst Gleichlaufräsen
Preferably climb milling

Berechnungsformeln Calculating formulas

Drehzahl Speed

$$n = \frac{v_c \cdot 1000 \cdot f_1}{\pi \cdot d_1}$$

v_c Tab. Seite Page 230

Vorschubgeschwindigkeit Feed rate

$$v_f = f_z \cdot Z \cdot n \cdot f_2$$

f_z Tab. Seite Page 230

Spanvolumen Chip Volume

$$Q = \frac{a_e \cdot a_p \cdot v_f}{1000}$$

f_z Tab. Seite Page 230



Zahnformfräser

Gear Milling Cutters

Auswahlübersicht Selection table	235
Zahnform-Vorfräser Gear Roughing Cutters	236
Zahnform-Scheibenfräser mit Form-Wendeplatten Circular-type Gear Profile Cutters with Form Indexable Inserts	238
Rotoren-Vorfräser mit Wendeplatten Roughing Cutters for Rotors with Indexable Inserts	240
Rotoren-Profilfräser mit eingesetzten Messern Rotor Profile Cutters with Inserted Blades	242
Schnittwertempfehlungen Cutting data recommendations	244, 245

Zahnformfräser Gear Milling Cutters



Auswahlübersicht Selection table

Zahnformfräser Gear Milling Cutters

	Kat.-Nr. Cat.-No.			Seite Page
	2667	Zahnform- Vorfräser Gear Roughing Cutters		236
	2675	Zahnform- Fertigfräser Gear Finishing Cutters		238
	2695	Rotoren-Vorfräser Rotor Roughing Cutters		240
	2690	Rotoren-Profilfräser Rotor Profile Cutters		242

Eingriffswinkel 20°
Bezugsprofil IV nach DIN 3972
mit Längsnut und Quernut DIN 138

20° pressure angle
basic profile IV to DIN 3972
with keyway and drive slot to DIN 138

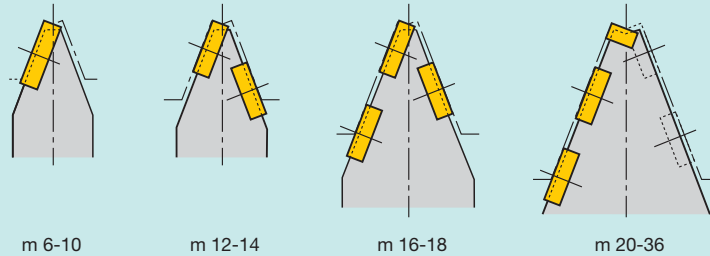

N = Anzahl der Schneidkanten N = Number of cutting edges							Schneidstoffsorten Cutting materials												Für Fräser For cutter					
							Ident No.																	
	l	s	d	d ₁	b/r	ISO-Code Cat-No.	LC240T	LC240S	LC230F	LC225T	LC225S	LC630T	LW240	LW225	LC440T	LC444W	LC610E	LC610T		LC610W	LC610A	LW610	LC603Z	Cat-No.
<p>N = 4</p>	12,7	6,35	14,3	5,5	0,78	LNHX 1206 1185-11	2127693			2340217	2127683		1063104	1063102								1063111		2667 2695
	19,05	6,35	14,3	5,5	0,78	LNHX 1906 1185-31				2306819	2127682			1063148				2346241				1063139		
	25,4	5	14,3	5,5	1,1	LNHX 2505 1185-32				4029351	2303419			2214362								4024397		
<p>N = 4</p>	15,88	7,94	12,7	5,4	1,65	LNHX 1207 1185-15				2308646	1063115			2219236				1063118				1063116		2667 2695
	19,05	6,35	14,3	5,8		LNHX 1906 1185-35				1063136	1063135													2667 2695
<p>N = 4</p>	25,4	5	14,3	5,5		LNHX 2505 1185-33				2345789	2306829			2289399										

Sonderprofile siehe Seite 243
Special profiles see page 243

Sortenbeschreibung/-bezeichnung und ISO-Code ab Seite 22
Description/Designation of grades and ISO-Code starting page 22

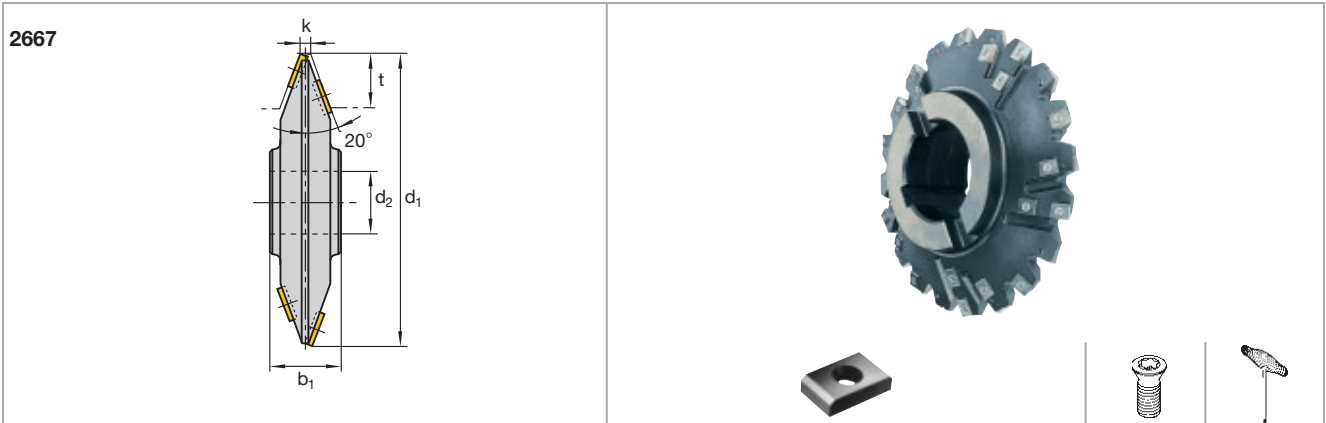

m	d ₁	b ₁	d ₂	z	k	t	1185-11	1185-31	1185-32	1185-33	Ident No.	Ident No.
							Anzahl der Wendeplatten Number of indexable inserts					
6	160	50	50	12	3,14	17				12	1045766	1048335
6	220	50	60	16	3,14	17				16		
6	280	50	80	20	3,14	17				20		
8	180	50	50	12	4,41	23			12			
8	220	50	60	16	4,41	23			16			
8	280	50	80	20	4,41	23			20			
10	180	60	50	12	5,67	23			12			
10	220	60	60	16	5,67	23			16			
10	280	60	80	20	5,67	23			20			
12	200	60	50	12	6,93	32		18			1045777	1048344
12	250	60	60	16	6,93	32		24				
12	320	60	80	20	6,93	32		30				
14	200	60	50	12	8,20	32		18				
14	250	60	60	16	8,20	32		24				
14	320	60	80	20	8,20	32		30				
16	200	70	50	12	9,47	49		24				
16	250	70	60	16	9,47	49		32				
16	320	70	80	20	9,47	49		40				
18	200	70	50	12	10,75	49		24				
18	250	70	60	16	10,75	49		32				
18	320	70	80	20	10,75	49		40				
20	220	80	60	12	12,03	49	6	18				
20	280	80	80	16	12,03	49	8	24				
20	360	80	100	20	12,03	49	10	30				
22	250	80	60	12	13,32	65	6	24				
22	300	80	80	16	13,32	65	8	32				
22	360	80	100	20	13,32	65	10	40				
24	250	80	60	12	14,61	65	6	24				
24	300	80	80	16	14,61	65	8	32				
24	360	80	100	20	14,61	65	10	40				
26	320	100	80	16	15,89	65	8	32				
26	400	100	100	20	15,89	65	10	40				
28	320	100	80	16	17,18	65	8	32				
28	400	100	100	20	17,18	65	10	40				
30	320	100	80	16	18,46	80	8	40				
30	400	100	100	20	18,46	80	10	50				
32	340	100	80	16	19,76	80	8	40				
32	420	100	100	20	19,76	80	10	50				
34	340	100	80	16	21,05	95		56				
34	420	100	100	20	21,05	95		70				
36	340	100	80	16	22,35	95		56				
36	420	100	100	20	22,35	95		70				

$$z_{\text{eff}} = \frac{z}{2}$$

Schnittwertempfehlungen ab Seite 244
Cutting data recommendations starting page 244

**Zahnform-Scheibenfräser mit Form-Wendeplatten,
 Katalog-Nr. 2675
 Circular-type Gear Profile Cutters with Form Indexable Inserts,
 Cat. No. 2675**

Diese Zahnformfräser sind Hochleistungs-Werkzeuge zum Fertigverzahnen. Eine doppelt negative Schneidengeometrie in Verbindung mit hoher Messerzahl ergibt gutes Schneidverhalten (Schälschnitt). Wendeplatten von hoher Genauigkeit und Schliffgüte erzeugen saubere Radflanken. Durch zusätzliche Hartstoff-Beschichtungen werden hohe Standzeiten erreicht.

These gear milling cutters are high-performance tools for finish-milling. A double negative cutter geometry combined with a high number of blades produces good cutting behaviour (peeling cut). Indexable inserts with high accuracy and surface finish quality produce clean gear flanks. In addition, long service life is ensured by additional hard material coatings.

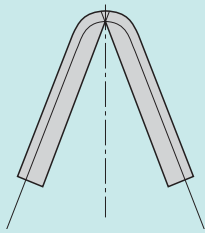

**z. B. Außenverzahnung
 Example: external gear**

Zum Vorfräsen empfehlen wir Zahnform-Schruppfräser entsprechend Fette Kat.-Nr. 2667

Modul 16
 Module 16
 $\alpha_0 = 20^\circ$
 $z = 89$

For rough-hobbing we recommend gear roughing cutters Fette Cat.-No. 2667.

Fräser-Ø: 300 mm
 Bohrungs-Ø: 80 mm
 Form-Wendeplatten: 24

Cutter diameter: 300 mm
 Bore diameter: 80 mm
 Form indexable inserts: 24

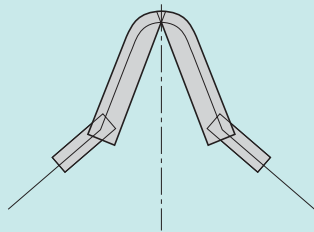

**z. B. Innenverzahnung
 Example: internal gear**

Modul 10
 Module 10
 $\alpha_0 = 20^\circ$
 $z = 94$

Fräser-Ø: 380 mm
 Bohrungs-Ø: 80 mm
 Form-Wendeplatten: 30
 Wendeplatten für Kantenbruch: 10

Cutter diameter: 380 mm
 Bore diameter: 80 mm
 Form indexable inserts: 30
 Indexable inserts for chamfer: 10

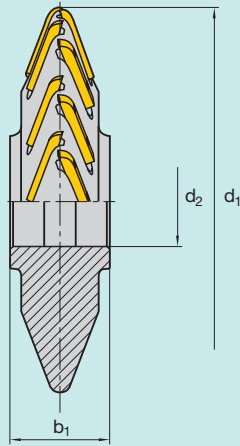

- Mit Hartmetall-Formwendeplatten
- Evolventenprofil
- Für Außen- oder Innenverzahnung
- Wechselseitig schneidend
- Längs- oder Quernut nach DIN
- Eingriffswinkel 20°
- z = Messerzahl

Die Baureihe zeigt Richtwerte für hohe Rad-Zähnezahlen. Die Fräserdurchmesser sind schneidenzahlabhängig. Abweichende Baumaße sind möglich.

- With carbide form indexable inserts
- Involute profile
- For external or internal gears
- Alternate cutting
- With keyway or drive slot to DIN
- Pressure angle 20°
- z = number of blades

The range shows guide values for high numbers of gear teeth. The cutter diameters are determined by the number of cutting edges. Alternative structural dimensions are possible.

Modul Module	z = 24	z = 28	z = 32
8			
10	d1 300	350	420
12	b1 70	80	100
14	d2 80	80	100
16			
18			
20			
22			
24			
26			

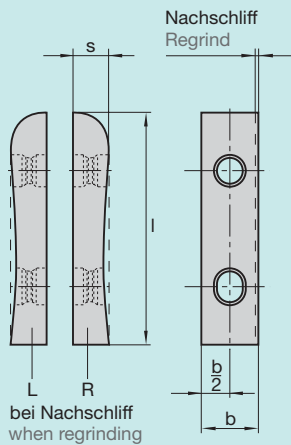

Hartmetall-Form-Wendeplatten

- Evolventenprofil
- für Außen- oder Innenverzahnung
- allseitig geschliffen
- 2 Schneiden
- Lieferung satzweise, 1 Satz = z Stück

Diese Form-Wendeplatten haben im Neuzustand 2 Schneiden. Sie können sowohl rechts- als auch linksseitig eingesetzt werden. Die Wendeplatten sind nachschleifbar. Das Nachschleifen erfolgt durch Planschleifen der Spanflächen, jedoch nur an einer Seite. Bei nachgeschliffenen Sätzen ist zu unterscheiden zwischen Rechts- und Linkswendeplatten.

Carbide form indexable inserts

- Involute profile
- For external or internal gears
- Ground on all faces
- 2 cutting edges
- Supplied in sets, 1 set = z off

These form indexable inserts have two cutting edges in the new condition. They can be employed on both the right-hand and left-hand sides.

The indexable inserts can be reground. Regrinding entails surface grinding of the cutting faces, but on one side only. When regrinding sets, note the difference between right-hand and left-hand indexable inserts.

Modul Module	l	b	s
8	25,40	14,30	5,00
10	31,75	14,30	6,35
12	31,75	14,30	6,35
14	38,10	14,30	7,14
16	44,45	14,30	7,94
18	50,80	14,30	7,94
20	57,15	14,30	8,73
22	66,68	14,30	9,53
24	66,68	14,30	9,53

HL = Hauptläufer (MALE)
NL = Nebelläufer (FEMALE)
Wendeplatten tangential angeordnet
Längsnut DIN 138

HL = male rotor
NL = female rotor
indexable inserts arranged tangentially
with keyway to DIN 138

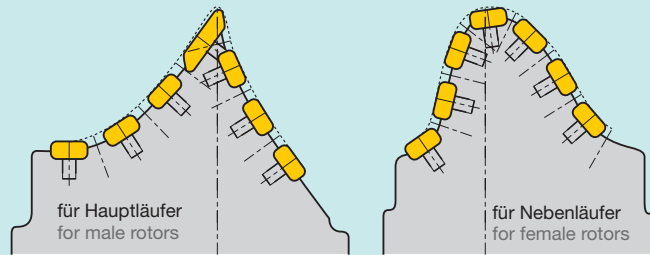

N = Anzahl der Schneidkanten N = Number of cutting edges						ISO-Code Cat-No.	Schneidstoffsorten Cutting materials Ident No.											Für Fräser For cutter Cat-No.					
	l	s	d	d ₁	b/r		LC240T	LC240S	LC230F	LC225T	LC225S	LC630T	LW240	LW225	LC440T	LC444W	LC610E		LC610T	LC610W	LC610A	LW610	LC603Z
 N = 4	12,7	6,35	14,3	5,5	0,78	LNHX 1206 1185-11	2127693			2340217	2127683		1063104	1063102				2346055			1063111		2667 2695
	19,05	6,35	14,3	5,5	0,78	LNHX 1906 1185-31			2306819	2127682			1063148				2346241				1063139		
	25,4	5	14,3	5,5	1,1	LNHX 2505 1185-32			4029351	2303419			2214362								4024397		
 N = 4	15,88	7,94	12,7	5,4	1,65	LNHX 1207 1185-15			2308646	1063115			2219236				1063118				1063116		2667 2695
	19,05	6,35	14,3	5,8		LNHX 1906 1185-35			1063136	1063135													2667 2695
 N = 4	25,4	5	14,3	5,5		LNHX 2505 1185-33			2345789	2306829			2289399										

Sortenbeschreibung/-bezeichnung und ISO-Code ab Seite 22
Description/Designation of grades and ISO-Code starting page 22

<p>2695</p> <p>HL NL</p>						
Rotormaße Rotor measurements			Rotormaße Rotor measurements			Anzahl der Wendepplatten Number of indexable inserts
Außen-Ø Outside diameter	Profilhöhe Profile height	Art Type	d ₁	b ₁	d ₂	
100	22	HL	220	60	60	25–36
100	22	NL	220	60	60	
127,5	27,5	HL	250	70	80	32–45
127,5	27,5	NL	250	70	80	
163,2	35,5	HL	250	80	80	40–56
163,2	35,5	NL	250	80	80	
204	44	HL	300	100	100	50–70
204	44	NL	300	100	100	
255	55	HL	320	125	100	63–85
255	55	NL	320	100	100	
318	70	HL	350	160	100	70–100
318	70	NL	350	125	100	

Diese Werkzeuge sind wegen ihrer hohen Abtragsleistungen und problemlosen Instandhaltung besonders wirtschaftlich.

Das Profil wird polygonförmig aus geraden Abschnitten gebildet und enthält ein Mindestaufmaß zum Schlichtfräsen.

Um möglichst parallele Schlichtaufmaße zu erzielen, werden neben den Standardwendepplatten auch modifizierte Formen eingesetzt. Diese sind mit Fasen oder Abrundungen versehen.

Für Rotoren aus nichtrostenden Cr-Legierungen oder für Maschinen mit geringer Antriebsleistung erfolgt die Bestückung wahlweise mit KHSS-E-Wendepplatten mit positiven Hohlkehlen.

These tools are particularly economical, because of their high cutting rates and trouble-free maintenance.

The profile is formed as a polygon from straight sections and contains a minimum allowance for finish milling.

To achieve finishing allowances which are as parallel as possible, modified forms are used in addition to the standard indexable inserts. These are provided with chamfers or rounded edges.

For rotors in stainless chromium alloys or for machines with low drive power, the tools can be fitted optionally with KHSS indexable inserts with ridges.

für Schraubenverdichter
für Hauptläufer oder Nebenläufer
mit eingesetzten Messern

for screw compressors
for male rotors or female rotors
with inserted blades

Fertigfräser
Spanwinkel radial 0°
axial 0°

Finishing cutter
rake angle 0° radial,
0° axial

Messer radial und axial nachstellbar
Messerspannung durch Spannkeil
und Schraube mit Längsnut DIN 138

blades radially and axially resettable
blade clamping by chucking wedge
and screw with keyway

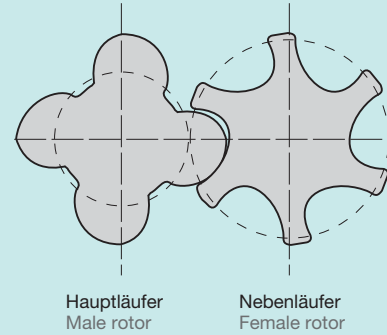

2690

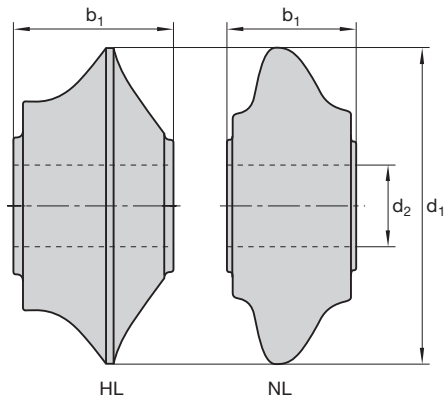

Fräser für Hauptläufer
Cutter for male rotor

Fräser für Nebenläufer
Cutter for female rotor

Rotormaße Rotor measurements			Fräsermaße Cutter measurements			Anzahl der Messer Number of cutting edge z
Außen-Ø Outside diameter	Profilhöhe Profile height	d ₁	Hauptläufer Male rotor b ₁	Nebenläufer Female rotor b ₁	d ₂	
127,5	27,5	210	70	50	60	16
163,2	35,5	220	85	65	60	16
204,0	44,0	235	105	80	60	16
255,0	55,0	290	125	100	80	16
255,0	55,0	340	125	100	100	20
318,0	70,0	360	160	125	100	20
400,0	86,0	380	200	160	100	20

Rotoren-Scheibenfräser müssen im Außendurchmesser in geringen Grenzen konstant gehalten werden, da sich Durchmesseränderungen auf das erzeugte Schraubenprofil auswirken. Deshalb erfolgt das Scharfschleifen dieser Werkzeuge im Fasenschleifverfahren. Die radiale Nachstellung der Messer erfolgt durch Stellschrauben, die Breitenverstellung ist durch gestaffelte Rillenverzahnung in Stufen von 0,25 mm möglich.

Circular type cutters for rotors must be kept in close limits as regards their outside diameter, since changes in diameter will affect the generated screw profile. This is why these tools are ground by the land grinding method. The blades are radially adjusted by means of set screws, the width adjustment is made possible by the staggered serrations in steps of 0,25 mm.

Die Fräserprofile überschneiden den Rotor-Außendurchmesser und erzeugen das gesamte Lückenprofil einschließlich Kopfradien und Dichtkanten.

The cutting profiles top the rotor o.d. and generate the entire gap profile including tip radii and sealing strips.

Bei Anfragen benötigen wir Werkstückzeichnungen mit Profilangaben. Wir übernehmen die Berechnung der Fräserprofile.

To deal with enquiries, we need workpiece drawings with profile data. We carry out the computation of the cutter profiles.

Ersatzmesser sind im Profil mit Schleifaufmaß vorgearbeitet und an den Spanflächen geschliffen.

Replacement blades are pre-machined with grinding allowance on the profile and are ground on the cutting faces.



Abb. 1 Standard-Ausführung

V-förmige Kopfform mit hoher Schneidenzahl im Bereich der Schneidenecken.
Nur 2 Plattengrößen von m 14 bis m 36

Fig. 1 Standard version

V-shaped tip form with high number of cutting edges in the corner region.
Only two insert sizes from M 14 to M 36

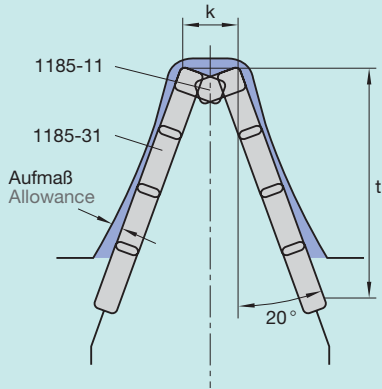

Abb. 2 Sonderprofil

gerundete Kopfform, gerade Flanken
Standard-Wendepplatten
3 Plattengrößen

Fig. 2 Special profile

rounded tip form, straight flanks
Standard indexable inserts
Three insert sizes

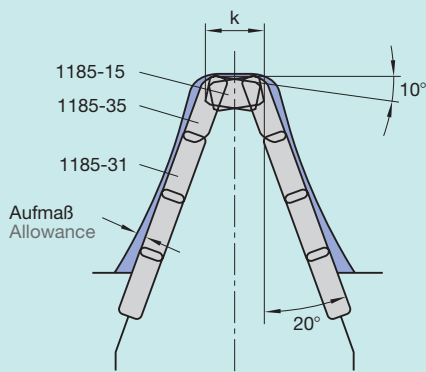

Abb. 3 Sonderprofil

Konstantes Bearbeitungs-Aufmaß
Flanke der Evolvente angenähert, großer Kopradius

Fig. 3 Special profile

Constant machining allowance
Flank approaching involute form, large tip radius

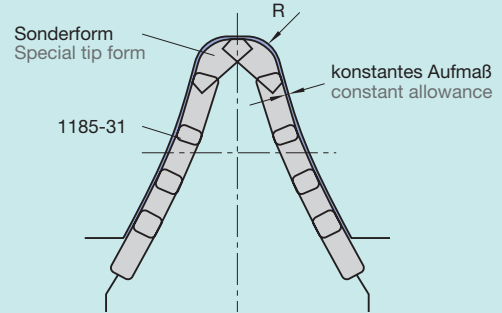

Abb. 4 Sonderprofil

mit Protuberanz zum Fertigfräsen des Zahngrundes
parallele Bearbeitungs-Zugabe angenäherte Evolvente

Fig. 4 Special profile

with protuberance for finish-milling of the tooth root
parallel machining allowance approaching involute form

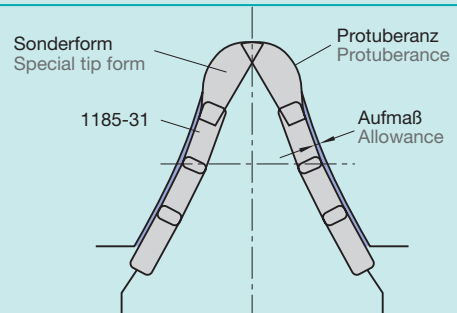

Abb. 5 Sonderprofil

für Innen-Verzahnung Standard-Wendepplatten
angenäherte Evolvente

Fig. 5 Special profile

for internal gears Standard indexable inserts
approaching involute form

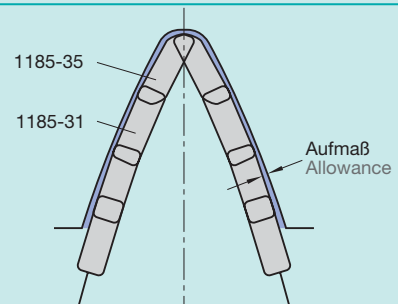

Abb. 1

Die Fräserprofile entsprechen DIN 3972 IV.
Bei ausreichender Antriebsleistung sollte volle Frästiefe $a_e \approx 2 \cdot m$ gewählt werden.
Gleichlaufräsen ist zu bevorzugen.

Richtwerte

V_c – nach Abb. 2
 f_z – nach Abb. 3
 n – nach Formel (1)
 v_f – nach Formel (3)
Q – und P – nach Abb. 4, gültig für $a_e \approx 2 \cdot m$.

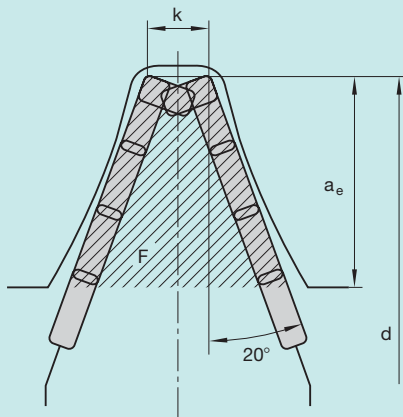
Für kleinere a_e , z. B.:

Fräsen in 2 Schnitten, sind Formeln (4) bis (7) zu verwenden.

Fig. 1

The cutter profiles comply with DIN 3972 IV.
If the drive power is sufficient, $a_e \approx 2 \cdot m$ should be selected as the full cutting depth.
Climb milling should be preferred.

Commended values

V_c – to Fig 2
 f_z – to Fig. 3
 n – according to formula (1)
 v_f – according to formula (3)
Q and P – to Fig. 4, applicable for $a_e \approx 2 \cdot m$.

For lower values of a_e , e. g. two-pass cutting, the formulas (4) to (7) should be employed.

m	= Modul Module	
A_L	= Eingriffswinkel Pressure angle	20°
d	= Fräserdurchmesser Cutter diameter	[mm]
k	= Kopfbreite am Fräser $\approx 0,6 \cdot m$ (Kat. 2667) Head width on the cutter $\approx 0.6 \cdot m$ (Cat. 2667)	[mm]
z	= Zähnezahl des Fräasers Number of cutter teeth	
z_{eff}	= $z/2$, wirksame Zähnez. Effective number of cutter teeth	
V_c	= Schnittgeschwindigkeit Cutting speed	[m/min]
n	= Drehzahl Speed	[min ⁻¹]
a_e	= radiale Frästiefe Radial cutting depth	[mm]
h_m	= mittlere Kopfspandicke = 0,1 mm gewählt mean tip chip thickness = 0.1 mm selected	[mm]
f_z	= Vorschub pro Zahn Feed per tooth	[mm]
v_f	= Vorschubgeschwindigkeit Feed rate	[mm/min]
F	= Flächen-Querschnitt Surface cross-section	[mm ²]
R_m	= Zugfestigkeit Tensile strength	[N/mm ²]
Q	= Spanvolumen Chip volume	[cm ³ /min]
L_f	= Leistungsfaktor Efficiency factor	[cm ³ /min · kW]
P_e	= Antriebsleistung Drive power	[kW]

Formeln Formulas

- (1) $n = (1000 \cdot V_c) / (d \cdot \pi)$
- (2) $f_z = h_m \cdot \sqrt{d/a_e}$
- (3) $v_f = n \cdot f_z \cdot z_{\text{eff}}$
- (4) $F = a_e \cdot k + a_e^2 \cdot \tan(A_L)$
- (5) $Q = F \cdot v_f / 1000$
- (6) $L_f = 28 - R_m/118$
- (7) $P_e = Q/L_f$

Beispiel Example

m	= 25	V_c	= 125 m/min
A_L	= 20°	f_z	= 0,28 mm
z	= 20	z_{eff}	= 10
k	= 15 mm	Q	= 460 cm ³ /min
R_m	= 800 N/mm ²	n	= 100 min ⁻¹
d	= 400 mm	v_f	= 279 mm/min
a_e	= 50 mm	P_e	= 22 kW
h_m	= 0,1 mm		

Abb. 2
Fig. 2



Abb. 4
Fig. 4



Abb. 3
Fig. 3



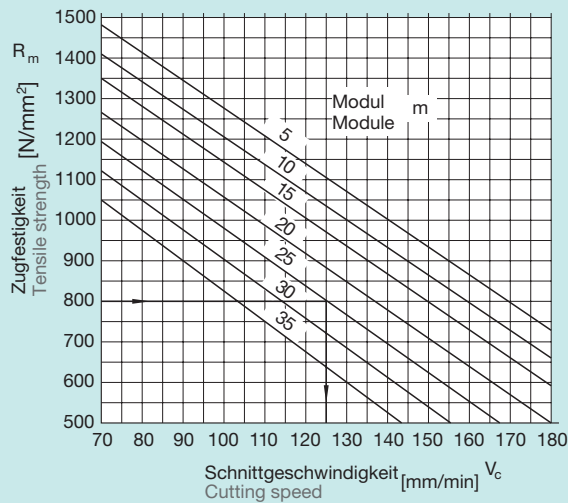



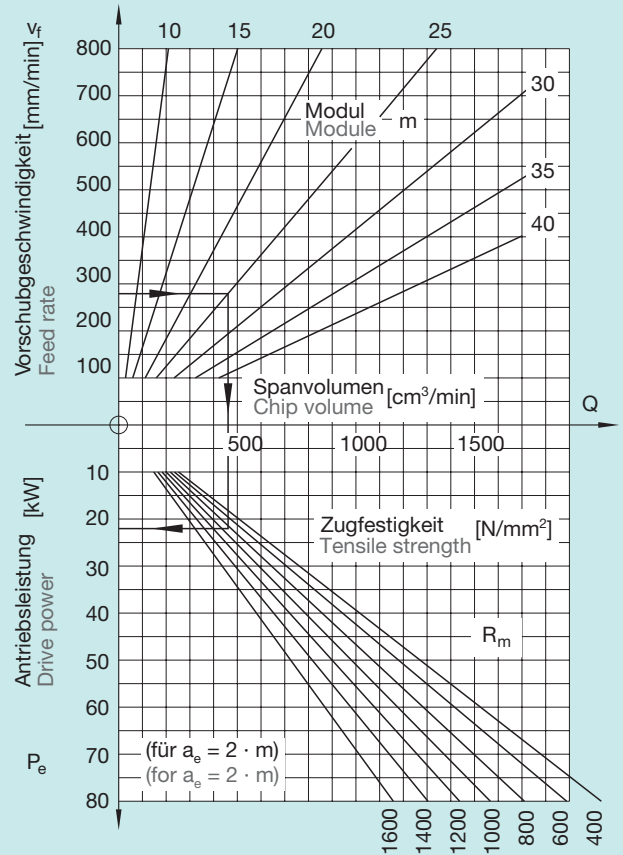
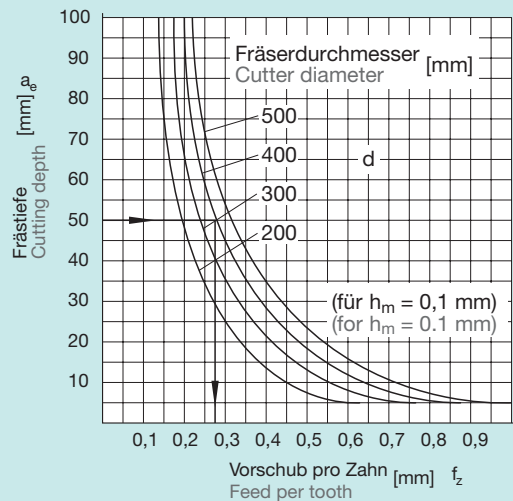

Werkzeuge mit polykristallinen Schneiden (PKD, CBN) (gelötet, WSP) Tools with polycrystalline Cutting Edges (PCD, CBN) (brazed)

PKD-Fräser	248
PCD end mill	
PKD Halbrund-Fräser Typ 200 Ø 2 - Ø 20	249
PCD half-round Ball-End Mill type 200 Ø 2 - Ø 20	
PKD Torusfräser GTP Ø 6 - Ø 32	250
PCD Toric Cutter GTP Ø 6 - Ø 32	
PKD Nutenfräser Typ 201 Ø - Ø 20	251
PCD Slotting End Mill type 201 Ø 2 - Ø 20	
PKD Nutenfräser Drallwinkel 30° Typ 202 Ø 2 - Ø 12	252
PCD Helical 30° type 202 Ø 2 - Ø 12	
Technische Hinweise	253
Technical hints	
CBN-Fräser	254
CBN end mill	
CBN Kugelfräser Typ 250 Ø 4 - Ø 20	255
CBN Ball-End Mill type 250 Ø 4 - Ø 20	
CBN Fräser, gerade Stirn Typ 251 Ø 2 - Ø 16	256
CBN straight flutes type 251 Ø 2 - Ø 16	
CBN Kugelfräser GRP Ø 3 - Ø 32	257
CBN Half-Round Ball-End Mill GRP Ø 3 - Ø 32	
CBN Torusfräser GTP Ø 3 - Ø 32	258
CBN Toric Cutter GTP Ø 3 - Ø 32	
Technische Hinweise	259
Technical hints	
Planfräser mit Wechselplatten aus PKD/CBN	
Face Milling Cutters with Indexable Inserts PKD/CBN	
FHD und EHD Universal Planfräser Ø 25 - Ø 125	260
FHD and EHD Universal Face Milling Cutters Ø 25 - Ø 125	
Wendeplatten für FHD/EHD	261
Indexable Inserts for FHD/EHD	
Werkzeughalter mit zylindrischem Schaft, Typ 290 Ø 20 - Ø 32	262
Tool holder on cylindrical shank, type 290 Ø 20 - Ø 32	
Wendeplatten Typ 220 und Typ 270	264
Tip type 220 and type 270	
Technische Hinweise	265
Technical hints	

Auswahlübersicht Selection table

PKD Fräser PCD end mill

	<p>Typ 200 PKD Kugelfräser (halbrund)</p> <p>Type 200 PCD half-rounded ball-end mill for no ferrous materials</p>
	<p>GTP Torusfräser (PKD)</p> <p>GTP Toric Cutter (PCD)</p>
	<p>Typ 201 PKD Nutenfräser</p> <p>Type 201 PCD end mill 2 flutes – Right-hand spiral for no ferrous materials</p>
	<p>Typ 202 PKD Nutenfräser (spiralförmig)</p> <p>Type 202 PCD helical 2 flutes end mill – Clockwise helical flutes for no ferrous materials</p>

Vollhartmetall PKD bestückt
Solid carbide with PCD Tips

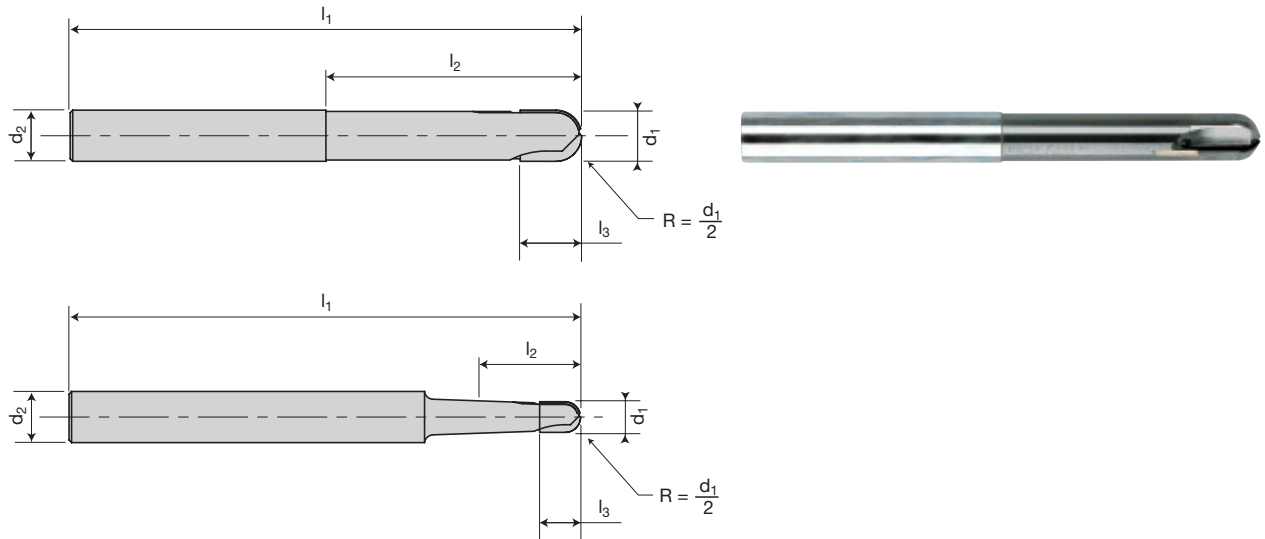

Katalog-Nr.	Cat.-No.	200
Typ	Type	N
Norm	Standard	Werksnorm
Zylinderschaft	Straight shank	≈ DIN 6535 HA
Schneidstoffarten	Cutting materials	

$d_1 - 0,03 - 0,08$	$d_2 h_6$	l_3	l_1	l_2	Ident No.
2	4	4	60	6	200 020
3	3	6	80	30	200 031
3	6	6	80	10	200 030
4	4	8	100	35	200 041
4	6	8	80	12	200 040
6	6	8	150	50	200 061
6	10	8	100	15	200 060
8	8	10	150	50	200 081
8	10	10	100	20	200 080
10	10	12	100	50	200 100
10	10	12	165	70	200 101
12	12	14	120	60	200 120
12	12	14	165	80	200 121
16	16	18	165	80	200 160
20	20	20	165	80	200 200

Präzisionswerkzeug in Hartmetall, in polycrystallinem Diamant und in Bornitrid
Precision tooling in carbide, polycrystalline diamond and polycrystalline borium materials

Hinweis: nachschleifbar
Note: This tool can be resharpened

Hartmetall/Stahl
Carbide/Steel

D = 3-12 mm
Hartmetall Carbide
D > 12 mm
Stahl Steel

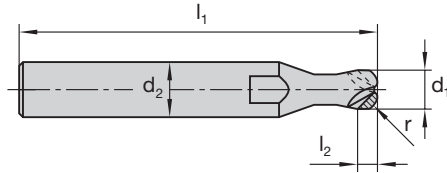

Zylinderschaft		Straight shank						LMT Standard	
Schneidstoffarten		Cutting materials						PKD PCD	
d ₁	d ₂	r	l ₁	l ₂	z	LMT Code	PKD Ident. No.		
6	8	1	100	5	1	GTP 06 11 00	DP 012		
							K121138		
8	10	2	100	5	1	GTP 08 11 00	DP 012		
							K121133		
10	12	3	100	5	2	GTP 10 11 00	DP 012		
							K121175		
12	16	4	100	6	2	GTP 12 11 00	DP 012		
							K121161		
16	16	5	130	10	2	GTP 16 11 00	DP 012		
							K121165		
20	20	6	160	14	2	GTP 20 11 00	DP 012		
							K121151		
25	25	6	160	13	2	GTP 25 11 00	DP 012		
							K121145		
32	32	8	175	16	2	GTP 32 11 00	DP 012		
							K121134		

Auf Anfrage in Sonderabmessungen lieferbar
Available in special dimensions on request

**Vollhartmetall PKD bestückt
stirnschneidend**

**Solid carbide with PCD Tips
end cutting**

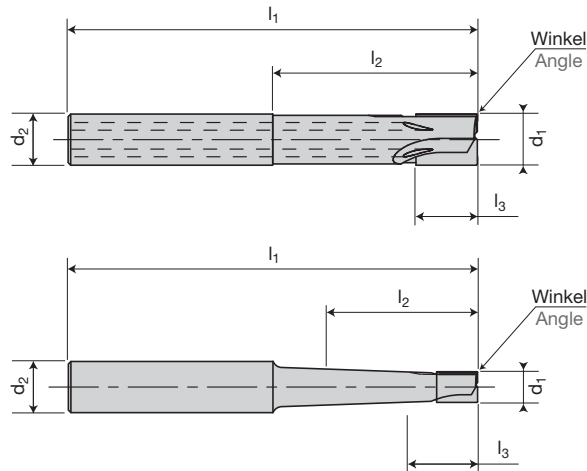

Katalog-Nr.	Cat.-No.	201
Typ	Type	N
Norm	Standard	Werksnorm
Zylinderschaft	Straight shank	≈ DIN 6535 HA
Schneidstoffarten	Cutting materials	

$d_1 -0,03-0,08$	$d_2 h_6$	l_3	l_1	l_2	Winkel 45° Angle 45°	Innere Kühlmittel- zuführung Central coolant	Ident No.
1	3	2	60	3	0,05		201 010
2	4	4	60	6	0,05		201 020
3	3	6	80	40	0,05		201 031
3	6	6	80	10	0,05		201 030
4	4	8	80	40	0,1		201 041
4	8	8	80	12	0,1		201 040
6	6	8	100	50	0,1		201 061
6	10	8	80	15	0,1		201 060
8	8	10	120	60	0,1	x	201 081
8	10	10	80	20	0,1	x	201 080
10	10	12	120	60	0,2	x	201 100
12	12	14	120	60	0,2	x	201 120
14	14	16	120	60	0,2	x	201 140
16	16	18	140	70	0,2	x	201 160
18	18	20	140	70	0,2	x	201 180
20	20	22	160	80	0,2	x	201 200

Präzisionswerkzeug in Hartmetall, in polycrystallinem Diamant und in Bornitrid
Precision tooling in carbide, polycrystalline diamond and polycrystalline borium materials
Hinweis: nachschleifbar
Note: This tool can be resharpened

Die Gravur des genauen Durchmessers ist auf jedem Fräser
Precise diameter engraved on every ball-end mill

Vollhartmetall PKD bestückt
Solid carbide with PCD Tips

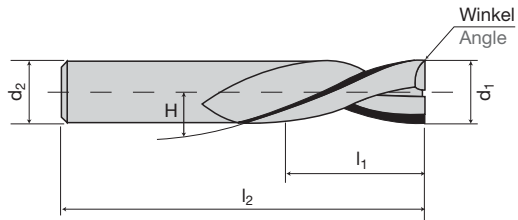

Katalog-Nr.	Cat.-No.	202
Typ	Type	N
Norm	Standard	Werksnorm
Drallwinkel	Helix angle	30°
Zylinderschaft	Straight shank	≈ DIN 6535 HA
Schneidstoffarten	Cutting materials	

d_1 -0,03-0,08	$d_2 h_6$	l_2	l_1	Winkel 45° Angle 45°	Ident No.
3	4	6,4	50	0,05	202 030
4	4	9,5	76	0,1	202 040
5	5	9,5	76	0,1	202 050
6	6	9,5	76	0,1	202 060
8	8	9,5	76	0,1	202 080
10	10	12,7	89	0,2	202 100
12	12	12,7	89	0,2	202 120

Präzisionswerkzeug in Hartmetall, in polycrystallinem Diamant und in Bornitrid
Precision tooling in carbide, polycrystalline diamond and polycrystalline borium materials

Hinweis: nachschleifbar
Note: This tool can be resharpened

Material Material	Schnittgeschwindigkeit Cutting Speed m/min M/mn	Durchmesser Diameter mm	Vorschub/Zahn Feed/Tooth mm/Z mm/dt	Schnitttiefe a_p Hold of way submerged a_p mm	Schnittbreite a_e Side hold way a_e mm	Kühlmittel Lubricant
Alu ohne Si alu without Si	≥ 750	1 ~ 6	0,01 bis to 0,03	0,2 bis to 0,4 x d_1	1/2 bis to 2/3 x d_1	mit Kühlmittel Under lubrication
		8 ~ 12	0,03 bis to 0,08			
		14 ~ 20	0,06 bis to 0,14			
Alu 7 % Si alu 7 % Si	≥ 300	1 ~ 6	0,01 bis to 0,03	0,2 bis to 0,4 x d_1	1/2 bis to 2/3 x v	mit Kühlmittel Under lubrication
		8 ~ 12	0,03 bis to 0,07			
		14 ~ 20	0,06 bis to 0,12			
Graphit graphite	500 bis 1000	1 ~ 6	0,01 bis to 0,05	0,25 bis to 0,5 x d_1	1/2 bis to 2/3 x d_1	Trocken + Luft Dry + air spray
		8 ~ 12	0,05 bis to 0,10			
		14 ~ 20	0,06 bis to 0,16			
Kupfer copper	≥ 750	1 ~ 6	0,005 bis to 0,03	0,2 bis to 0,4 x d_1	1/2 bis to 2/3 x d_1	Trocken Dry or micro- pulverisation
		8 ~ 12	0,03 bis to 0,07			
		14 ~ 20	0,06 bis to 0,12			

Vorbearbeitung Roughing

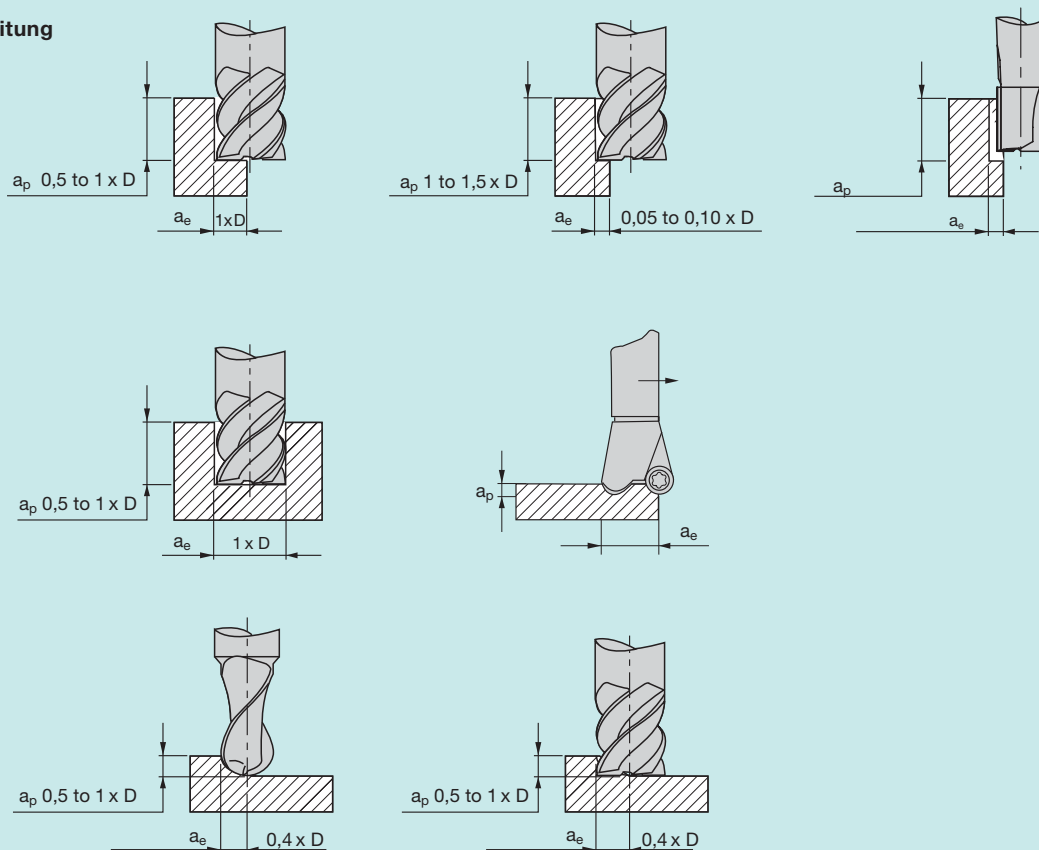

Präzisionswerkzeug in Hartmetall, in polycrystallinem Diamant und in Bornitrid
Precision tooling in carbide, polycrystalline diamond and polycrystalline borium materials

Auswahlübersicht Selection table

CBN Fräser CBN end mill

	<p>Typ 250 240° CBN Kugelfräser</p> <p>Type 250 CBN ball end mill 240° for ferrous materials</p>	<p>Kugeldurchmesser Ø 2 – Ø 25</p> <p>Ball diameter Ø 2 – Ø 25</p>
	<p>Typ 251 CBN Nutenfräser</p> <p>Type 251 CBN slotting end mill straight flutes for ferrous materials</p>	
	<p>GRP CBN Kugelfräser</p> <p>GRP CBN ball end mill for ferrous materials</p>	<p>Kugeldurchmesser Ø 10 – Ø 35</p> <p>Ball diameter Ø 10 – Ø 35</p>
	<p>GTP CBN Fräser</p> <p>GTP Torical CBN end mill for ferrous materials</p>	

Präzisionswerkzeug in Hartmetall, in polycristallinem Diamant und in Bornitrid
Precision tooling in carbide, polycrystalline diamond and polycrystalline borium materials

Vollhartmetall CBN bestückt
über Mitte schneidend

Solid carbide with CBN Tips
centre cutting

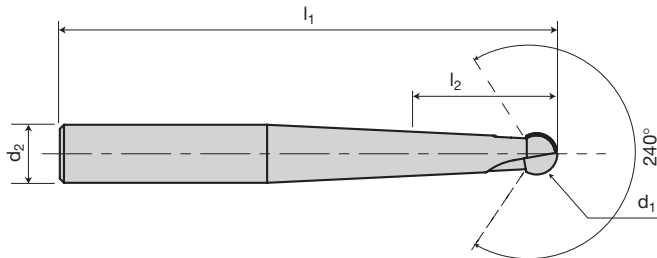

Katalog-Nr.	Cat.-No.	250		
Typ	Type	N		
Norm	Standard	Werksnorm		
Zylinderschaft	Straight shank	≈ DIN 6535 HA		
Schneidstoffarten	Cutting materials			
$d_1 -0,03-0,08$	$d_2 h_6$	l_1	l_2	Ident No.
4	8	60	8	250 040
5	10	80	8	250 050
6	10	80	10	250 060
8	12	100	15	250 080
10	14	120	23	250 100
12	14	120	36	250 120
14	16	120	42	250 140
16	16	130	75	250 160
20	20	140	80	250 200

Präzisionswerkzeug in Hartmetall, in polycrystallinem Diamant und in Bornitrid
Precision tooling in carbide, polycrystalline diamond and polycrystalline borium materials
Hinweis: nachschleifbar
Note: This tool can be resharpened

Die Gravur des genauen Durchmessers ist auf jedem Fräser
Precise diameter engraved on every ball-end mill

Vollhartmetall CBN bestückt
über Mitte schneidend

Solid carbide with CBN Tips
centre cutting

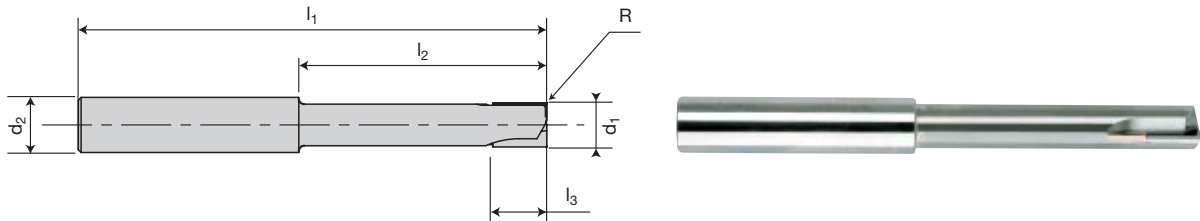

Katalog-Nr.	Cat.-No.	251
Typ	Type	N
Norm	Standard	Werksnorm
Zylinderschaft	Straight shank	≈ DIN 6535 HA
Schneidstoffarten	Cutting materials	

$d_1 - 0,03-0,08$	$d_2 h_6$	l_3	l_1	l_2	R	Ident No.
2	6	1,5	60	5	0,1	251 020
3	6	1,5	60	5	0,1	251 030
4	8	4	80	8	0,1	251 040
5	10	6	85	10	0,1	251 050
6	10	8	85	12	0,1	251 060
8	10	10	85	16	0,1	251 080
10	12	12	110	20	0,2	251 100
12	14	15	120	24	0,2	251 120
16	16	20	130	75	0,2	251 160

Präzisionswerkzeug in Hartmetall, in polycrystallinem Diamant und in Bornitrid
Precision tooling in carbide, polycrystalline diamond and polycrystalline borium materials
Hinweis: nachschleifbar
Note: This tool can be resharpened

Die Gravur des genauen Durchmessers ist auf jedem Fräser
Precise diameter engraved on every ball-end mill

Hartmetall/Stahl
Carbide/Steel

D = 3-12 mm
Hartmetall Carbide
D > 12 mm
Stahl Steel

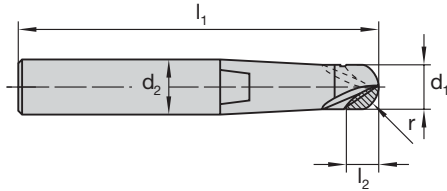

Zylinderschaft	Straight shank	LMT Standard					
Schneidstoffarten	Cutting materials	CBN CBN					
d ₁	d ₂	r	l ₁	l ₂	z	LMT Code	CBN Ident. No.
3	6	1,5	75	2,5	2	GRP 03 25 00	BN 023 K121169
4	6	2	75	2,5	2	GRP 04 25 00	BN 023 K121171
5	6	2,5	75	3	2	GRP 05 25 00	BN 023 K121173
6	8	3	100	6	1	GRP 06 21 00	BN 011 K121181
8	10	4	100	7	1	GRP 08 21 00	BN 011 K121176
10	12	5	100	8	2	GRP 10 21 00	BN 011 K121203
12	16	6	100	9	2	GRP 12 21 00	BN 011 K121207
16	16	8	130	11	2	GRP 16 21 00	BN 011 K121211
20	20	10	160	13	2	GRP 20 21 00	BN 011 K121196
25	25	12,5	160	15	2	GRP 25 21 00	BN 011 K121190
32	32	16	175	19	2	GRP 32 21 00	BN 011 K121177

Auf Anfrage in Sonderabmessungen lieferbar
Available in special dimensions on request

Hartmetall/Stahl
Carbide/Steel

D = 3 - 12 mm
Hartmetall Carbide
D > 12 mm
Stahl Steel

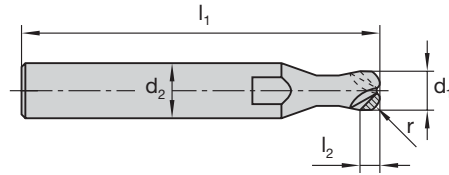

Zylinderschaft		Straight shank						LMT Standard	
Schneidstoffarten		Cutting materials						CBN CBN	
d ₁	d ₂	r	l ₁	l ₂	z	LMT Code	CBN Ident. No.		
3	6	0,3	75	0,6	2	GTP 03 21 00	BN 011	K121125	
4	6	0,3	75	0,6	2	GTP 04 21 00	BN 011	K121126	
5	6	0,3	75	0,6	2	GTP 05 21 00	BN 011	K121127	
6	8	1	100	5	1	GTP 06 21 00	BN 011	K121131	
8	10	2	100	5	1	GTP 08 21 00	BN 011	K121123	
10	12	3	100	5	2	GTP 10 21 00	BN 011	K121159	
12	16	4	100	6	2	GTP 12 21 00	BN 011	K121163	
16	16	5	130	10	2	GTP 16 21 00	BN 011	K121149	
20	20	6	160	14	2	GTP 20 21 00	BN 011	K121153	
25	25	6	160	13	2	GTP 25 21 00	BN 011	K121147	
32	32	8	175	16	2	GTP 32 21 00	BN 011	K121136	

Auf Anfrage in Sonderabmessungen lieferbar
Available in special dimensions on request

Material Material	Härte Hardness HRC	Durchmesser Diametre mm	Schnittgeschwindigkeit Cutting speed m/min M/mn	Vorschub/Zahn Feed/Tooth mm/Z mm/dt	Schnittbreite a_e Over thickness a_e mm	Kühlmittel Lubricant
Legierter Stahl Mixed steel	38	2 bis to 4	400 bis to 900	0,01	0,05	Trocken + Luft Dry + air spray only
	38	4 bis to 8	400 bis to 900	0,02	0,15	
	38	8 bis to 14	400 bis to 900	0,05 bis to 0,07	0,15 bis to 0,25	
	38	14 bis to 20	400 bis to 900	0,1 bis to 0,15	0,25 bis to 0,1	
Legierter Stahl Mixed steel	41	2 bis to 4	300 bis to 800	0,01	0,05	Trocken + Luft Dry + air spray only
	41	4 bis to 8	300 bis to 800	0,02	0,15	
	41	8 bis to 14	300 bis to 800	0,05 bis to 0,07	0,15 bis to 0,25	
	41	14 bis to 20	300 bis to 800	0,1 bis to 0,15	0,25 bis to 0,5	
Legierter Stahl Mixed steel	50	2 bis to 4	300 bis to 500	0,01	0,05	Trocken + Luft Dry + air spray only
	50	4 bis to 8	300 bis to 500	0,02	0,1 bis to 0,15	
	50	8 bis to 14	300 bis to 500	0,05 bis to 0,07	0,15 bis to 0,25	
	50	14 bis to 20	300 bis to 500	0,1 bis to 0,15	0,25 bis to 0,4	
Legierter Stahl Mixed steel	55	2 bis to 4	250 bis to 400	0,01	0,05	Trocken + Luft Dry + air spray only
	55	4 bis to 8	250 bis to 400	0,02	0,05 bis to 0,1	
	55	8 bis to 14	250 bis to 400	0,05 bis to 0,07	0,1 bis to 0,2	
Guss Cast iron	55	14 bis to 20	250 bis to 400	0,1 bis to 0,15	0,2 bis to 0,3	Trocken + Luft Dry + air spray only
			400 bis to 900	0,15 bis to 0,25		

Fertigung Production

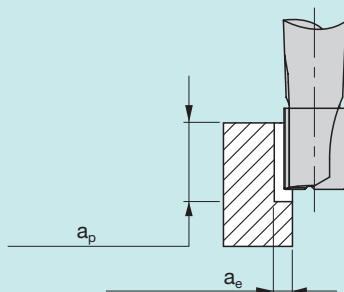

Achtung:

Fräser für Material zwischen 120 kg/m² bis 280 kg/m²

Beispiel:

4ZrMo4/X40CrMoV51/34CrNiMo8/GG25

Hinweis:

bitte wenden Sie sich an uns, für die Bearbeitung von Stahl mit Chrom > 18 %

Reminder:

These end mills are made for using of ferrous materials more than 120 kg/mm² until 280 kg/m²





Examples:

40 CD8, Z38CDV7, 35NCD16, CAST GL250,...

Note:

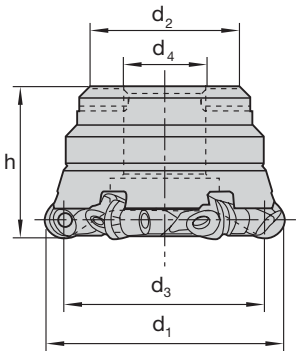



Please contact us for using of more than 18 % steel with chromium

FHD

LMT Code	Ident-No.	d ₁	d ₂	d ₃	d ₄	h	z 	Wendeplatte Insert	Klemmstück Clamping piece	
FHD00 R10.040AN	K200032	40	31,5	30	16	40	4	R 10 42	MKL 0 03 B	T10
FHD00 R10.050AN	K200033	50	41	40	22	40	5	R 10 42	MKL 0 03 B	T10
FHD00 R10.063AN	K200034	63	46	53	22	40	6	R 10 42	MKL 0 03 B	T10
FHD00 R10.080AN	K200035	80	61	70	27	50	8	R 10 42	MKL 0 03 B	T10
FHD00 R10.100AN	K200036	100	81	90	32	50	10	R 10 42	MKL 0 03 B	T10
FHD00 R10.125AN	K200037	125	90	115	40	63	12	R 10 42	MKL 0 03 B	T10

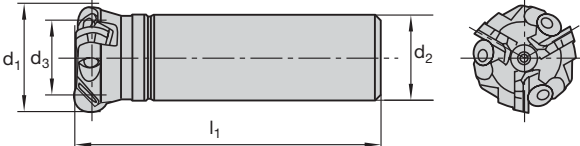

EHD

LMT Code	Ident-No.	d ₁	d ₂	d ₃	l ₁	z 	Wendeplatte Insert	Klemmstück Clamping piece	
EHD00 R10.025AE	K200030	25	16	15	100	2	R 10 42	MKL 002 B	T 8
EHD00 R10.032AG	K200031	32	25	22	120	3	R 10 42	MKL 002 B	T 8

Auf Anfrage in Sonderabmessungen lieferbar
Available in special dimensions on request

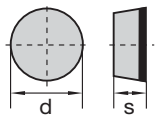
Wendepplatten Inserts						
		LMT Code	Ident-No.	d [mm]	s [mm]	α [°]
	scharfkantig sharp	R 10 42 S DP 012	K200038	10,0	4,2	11
	verrundet honed	R 10 42 SV BN 011	K200039	10,0	4,2	11
	scharfkantig sharp	R 10 42 S BN 011	K200659	10,0	4,2	11
	Neg.-Fase T-land	R 10 42 SN BN 011	K200660	10,0	4,2	11

Zubehör und Ersatzteile Accessories and Spares				
	LMT Code	Ident-No.	LMT Code	Ident-No.
	MKL 0 02 B	K280026	DS 04 LR 12 C Differentialschraube Differential setting screw	K200527
	MKL 0 03 B	K200041	DS 05 LR 12 C Differentialschraube Differential setting screw	K200528
	T 8, TORX-Schraubendreher T 8, TORX-Screwdriver	K119528		
	T 10, TORX-Schraubendreher T 10, TORX-Screwdriver	K200042		

Maximale Frästiefe beim Planfräsen Maximum depth of cut for face milling	
Werkstoff Material	R 10 42 S/SV/SN a_p [mm]
Gehärteter Stahl Hardened steel	0,5-0,8
Grauguss Cast iron	1-1,5
Aluminium Aluminium	5
Kunststoff Plastic	5

Maximaler Winkel beim schrägen Eintauchen Maximum angle for inclined immersion	
Durchmesser	R 10 42 S/SV/SN
25	14,0°
32	8,0°
40	5,5°
50	4,0°
63	2,7°
80	2,0°
100	1,5°
125	1,2°

Auf Anfrage in Sonderabmessungen lieferbar
Available in special dimensions on request

Werkzeughalter Tool holder

	<p>Typ 290 Werkzeughalter mit zylindrischem Schaft</p> <p>Type 290 Circular tool holder with cylindrical shank</p>
---	--

Platte Tips

	<p>Typ 220 PKD Platte</p> <p>Type 220 PCD tips for non ferrous materials</p>
	<p>Typ 270 CBN Platte</p> <p>Type 270 CBN tips for ferrous materials</p>

Präzisionswerkzeug in Hartmetall, in polycrystallinem Diamant und in Bornitrid
Precision tooling in carbide, polycrystalline diamond and polycrystalline borium materials

**Stahlkörper
rechtsschneidend**

**Steelbody
Clockwise cutting**

Toleranz $d_1 = \pm 0,05$
Wuchtgüte G 2,5 für
10 000 U/min
Tolerance on $d_1 = \pm 0,05$
Balanced tool holder
G 2,5 at 10 000 tr/mn

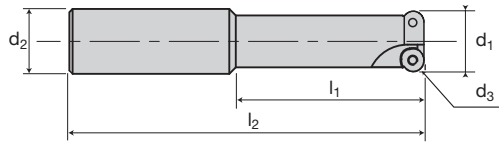

Katalog-Nr.	Cat.-No.	290
Typ	Type	
Norm	Standard	
Drallwinkel	Helix angle	
Zylinderschaft	Straight shank	
Schneidstoffarten	Cutting materials	

d_1	d_2	d_3	l_2	l_1	z ⚙	Ident No.
20	20	8	110	60	2	290 200
25	25	10	125	69	2	290 250
32	32	12	130	70	2	290 320

Präzisionswerkzeug in Hartmetall, in polycrystallinem Diamant und in Bornitrid
Precision tooling in carbide, polycrystalline diamond and polycrystalline borium materials

PKD Platte PCD tip

Typ 220

Einsetzbar auf Grundhalter 290/291/292/293 – Befestigung mit TORX-Schraube

Type 220

Usable on tools with following parts numbers: 290/291/292/293 – Fixed with TORX screw

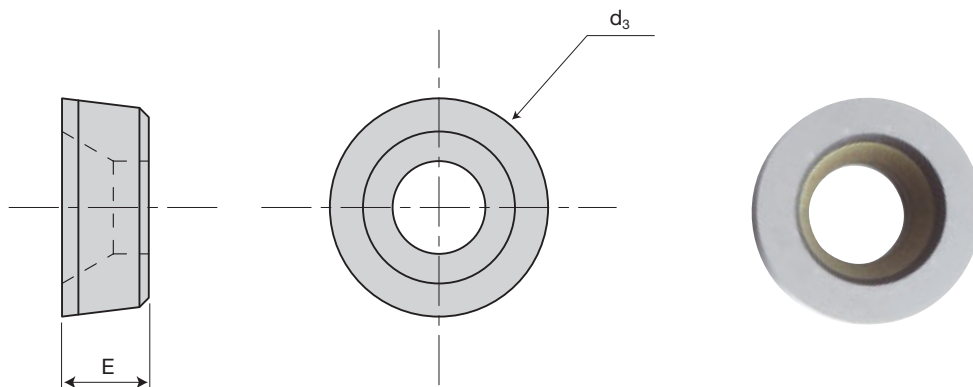

d_3	E	Referenz References
8	3,2	220 080
10	3,2	220 100
12	3,2	220 120

CBN Platte CBN tip

Typ 270

Einsetzbar auf Grundhalter 290/291/292/293 – Befestigung mit TORX-Schraube

Type 270

Usable on tools with following part numbers: 290/291/292/293 – Fixed with TORX screw

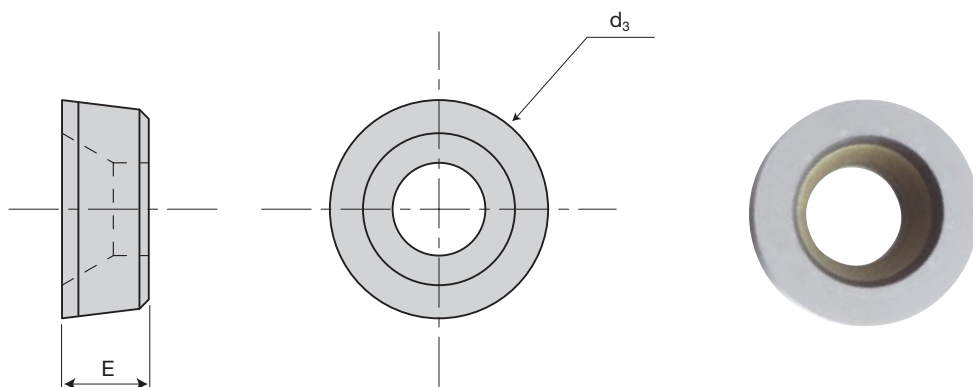

d_3	E	Referenz References
8	3,2	270 080
10	3,2	270 100
12	3,2	270 120

Präzisionswerkzeug in Hartmetall, in polycrystallinem Diamant und in Bornitrid
Precision tooling in carbide, polycrystalline diamond and polycrystalline borium materials

Technische Hinweise Technical hints

Schnittwertempfehlungen für Werkzeughalter mit PKD-Wendeplatten Cutting data recommendations for tool holder with PCD tips

Material Material	Schnittgeschwindigkeit Cutting Speed m/min M/mn	Durchmesser Diameter mm	Vorschub/Zahn Feed/Tooth mm/Z mm/dt	Schnitttiefe a_p Hold of way submerged a_p mm	Schnittbreite a_e Side hold way a_e mm	Kühlmittel Lubricant
Alu ohne Si alu without Si	≥ 750	20 ~ 32	0,2 bis to 0,3	2 bis to 3	1/2 bis to 2/3 x D1	mit Kühlmittel under lubrication
Alu 7 % Si alu 7 % Si	≥ 300	20 ~ 32	0,2 bis to 0,3	2 bis to 3	1/2 bis to 2/3 x D1	mit Kühlmittel under lubrication
Graphit graphite	500 bis to 1000	20 ~ 32	0,2 bis to 0,4	2 bis to 4	1/2 bis to 2/3 x D1	Trocken + Luft dry + air spray
Kupfer copper	≥ 750	20 ~ 32	0,15 bis to 0,3	1,5 bis to 2,5	1/2 bis to 2/3 x D1	Trocken + Luft dry or micro- pulverisation

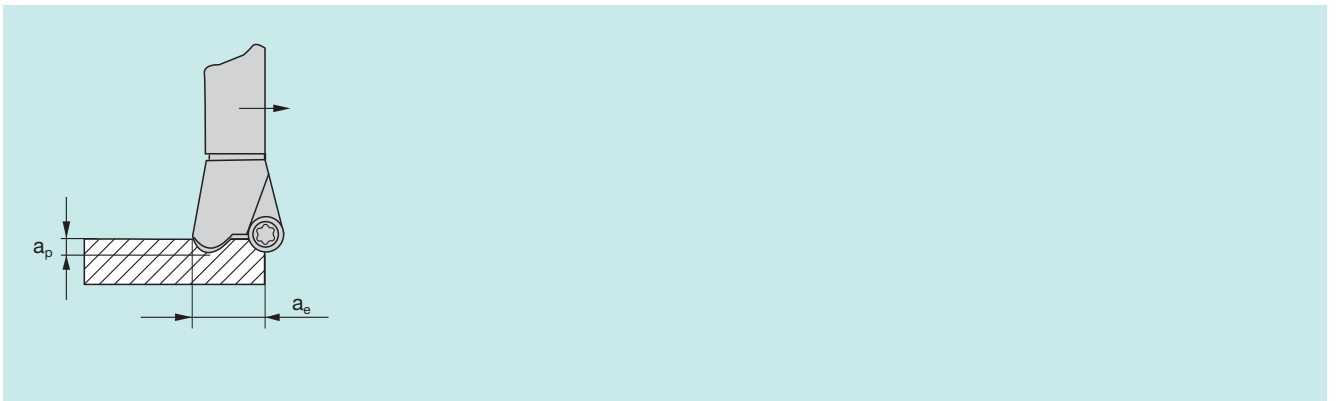

Schnittwertempfehlungen für Werkzeughalter mit CBN-Wendeplatten Cutting data recommendations for tool holder with CBN tips

Material Material	Härte Resistance HRC	Durchmesser Diameter mm	Schnittgeschwindigkeit Cutting speed m/min M/mn	Vorschub/Zahn Feed/Tooth mm/Z mm/dt	Schnitttiefe a_p Over thickness a_p mm	Schnittbreite a_e Pitch a_e mm	Kühlmittel Lubricant
Stahl Steel	35 ~ 40	20 bis to 32	250 ~ 300	0,2 bis to 0,25	1,5 bis to 2	0,5 bis to 2/3 x D1	Trocken + Luft Dry + air spray only
Stahl Steel	41 ~ 50	20 bis to 32	200 ~ 250	0,15 bis to 0,20	1,5	0,5 bis to 2/3 x D1	
Stahl Steel	> 50	20 bis to 32	100 ~ 200	0,10 bis to 0,15	1 bis to 1,5	0,5 bis to 2/3 x D1	

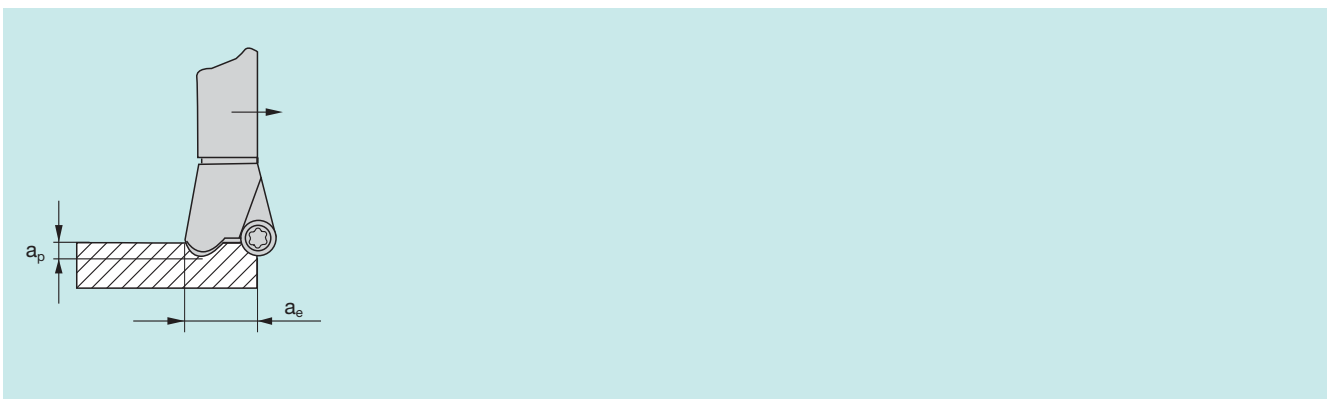

Präzisionswerkzeug in Hartmetall, in polycrystallinem Diamant und in Bornitrid
Precision tooling in carbide, polycrystalline diamond and polycrystalline borium materials



Fräswerkzeuge aus Vollhartmetall, Cermet und mit gelöteten HM-Schneiden

Milling Cutting Tools Solid Carbide, Cermet and with brazed Carbide Tips

Fräser für allgemeine Bearbeitung Milling Cutters for general machining	271
Gewindefräser, Fräser mit eingelöteten HM-Schneiden Thread Milling Cutters, Cutters with brazed carbide tips	291
HSC-line und Fräser für den Gesenk- und Formenbau HSC-line and Milling Cutters for mould and die industry	309
AIRline und Schafffräser zur Aluminium- und Kunststoffbearbeitung AIRline and End Mills for aluminium and plastic machining	331

Typenbeschreibung Type description











Fräswerkzeuge aus VHM-, Cermet und mit eingelöteten Schneiden Milling Cutting Tools Solid Carbide, Cermet and with brazed Carbide Tips

Fräser für allgemeine Bearbeitung Milling Cutters for general machining		Seite Page
	Auswahlübersicht Selection table	274
	2-Schneider 2-Flutes	276
		
	3-Schneider 3-Flutes	277
		
		278
	4- und Mehrschneider 4-Flutes and Multiple Flute	279
		280
		283
	Schrupfräser Roughing End Mills	281
		
Fräser mit innerer Kühlmittelzufuhr End Mills with internal coolant supply		Seite Page
	für Stahl for steel	282
		
	für Aluminium und Kunststoff for aluminium and plastic	277
	Schnittwertempfehlungen Cutting data recommendations	286

HSCLine und Fräser für Gesenk- und Formenbau HSCLine Milling Cutters for mould and die industry		Seite Page
	Auswahlübersicht Selection table	311
	HSCLine 2- und 3-Schneider 2- and 3-Flutes	316
		
		
		
	HSCLine Minifräser Mini-Cutters	318
		
	Diamantbeschichtete Schafffräser zur Grafitbearbeitung Diamond Coated End Mills for graphite machining	321
		
	Kugelnkopier-Schafffräser 2- und 4-Schneider Ball Nose Copying End Mills 2- and 4-Flutes	322
		
		
	Schafffräser Mehrschneider End Mills Multiple Flute	324
		
	Schnittwertempfehlungen Cutting data recommendations	326

Typenbeschreibung Type description

Fräswerkzeuge aus VHM-, Cermet und mit eingelöteten Schneiden Milling Cutting Tools Solid Carbide, Cermet and with brazed Carbide Tips

AIRline und Schafffräser zur Aluminium- und Kunststoffbearbeitung AIRline and End Mills for aluminium and plastic machining		Seite Page	Gewindefräser Thread Milling Cutters Fräser mit eingelöteten HM-Schneiden Cutters with brazed carbide Tips		Seite Page
	Auswahlübersicht Selection table	332		Auswahlübersicht Selection table	295
	AIRline Schafffräser für Aluminium und Thermoplaste AIRline End Mills for aluminium and thermoplastics	338		Gewindefräser Thread Milling Cutters	297
	Fräser für Al-Bleche und Pakete Milling Cutters for aluminium sheets and packages	340		Fräser mit eingelöteten HM-Schneiden Cutters with brazed carbide tips	300
	Fräser für harte Kunststoffe Milling Cutters for hard plastics	345		Schnittwertempfehlungen Cutting data recommendations	304
	Fräser für weiche Kunststoffe Milling Cutters for soft plastics	347			
	Fräser für Verbundwerkstoffe Milling Cutters for composites	350			
	Profilfräser End Mills for profiling				
	PKD-bestückte Fräser PCD Tipped Slotting End Mills	353			
	Sägeblätter Slitting Saws	355			
	Schnittwertempfehlungen Cutting data recommendations	357			



Fräser für allgemeine Bearbeitung

Milling Cutters for general machining

Auswahlübersicht Selection table	272
Typenbeschreibung Type description	274
Langloch- und Bohrnutenfräser Slotting End Mills and Slot Drills	
Zweischneider 2 Flutes	276
Schaftfräser End Mills	
Dreischneider 3 Flutes und mit innerer Kühlmittelzufuhr and with internal coolant supply	277
Schaftfräser End Mills	
Vier- und Mehrschneider 4 and more Flutes	279
Schaftschruppfräser, Chipmaster Roughing End Mills, Chipmaster	281
Schaftfräser End Mills	
Vier- und Mehrschneider 4 and more Flutes	282
Gravierfräser Engraving tools	285
Schnittwertempfehlungen Cutting data recommendations	286

Auswahlübersicht Selection table

Fräser für allgemeine Bearbeitung Milling Cutters for general machining

<ul style="list-style-type: none"> ● sehr gut geeignet well suited ○ auch geeignet also suited 					
Typ Type					
K = kurz short L = lang long EL = extra lang extra long Ausführung Design					
Zähnezahl No. of teeth					
Drallwinkel Helix angle					
Spanwinkel Rake angle					
Schneidstoffsorten Cutting material					
Seite Page					
Werkstoff	Material	Rm/UTS (N/mm ²)	Beispiel Example	DIN-No.	
Unlegierter Baustahl	Plain carbon steel	-700	St 52	1.0052	
Automatenstahl	Free cutting steel	-700	9 SMn 28	1.0715	
Baustahl	Structural alloy steel	500-950	Ck 45	1.1191	
			26 CrMo 4	1.7219	
Vergütungsstahl, mittelfest	Heat-treatable steel, medium strength	500-950	42 CrMo 4	1.7225	
			50 CrV 4	1.2241	
Stahlguß	Cast steel	-950	GS 40	1.0416	
Einsatzstahl	Case hardening steel	-950	16 MnCr 5	1.7131	
Rost- und säurebeständiger Stahl, ferritisch, martensitisch	Stainless steel, ferritic, martensitic	500-950	X 10 Cr 13	1.4006	
			X 12 CrMoS 17	1.4104	
			X 35 CrMo 17	1.4122	
Vergütungsstahl, hochfest	Heat-treatable steel, high strength	950-1400	42 CrMo 4	1.7225	
			30 CrNiMo 8	1.6580	
Nitrierstahl, vergütet	Nitriding steel	950-1400	34 CrAl 6	1.8504	
Werkzeugstahl	Tool steel	950-1400	X 38 CrMoV 5 1	1.2343	
			X 155 CrVMo 12 1	1.2379	
Rost- und säurebeständiger Stahl, austenitisch	Stainless steel, austenitic	500-950	X 5 CrNi 18 10	1.4301	
			X10 CrNiMo 18 10	1.4571	
Martensitaushärtbarer Stahl	Maraging steel			1.2709	
Grauguss	Grey cast iron	-550	GG25	0.6025	
Legierter Grauguss	Alloyed grey cast iron	300-700	GGL-NiCr 35 2	0.6678	
Sphäroguss	Nodular cast iron	-500	GGG60	0.7060	
Temperguss	Malleable cast iron	40-70	GTS55	0.8155	
Rein-Metalle, weich	Pure metals, soft	400-800 (120-310 HB)	Reineisen, Blei pure iron, lead	1.1003	
Aluminium-Legierungen, langspanend	Aluminium alloys, long chipping	100-400 (120-260 HB)	AlMg 3	3.3535	
Aluminium-Legierungen, kurzspanend	Aluminium alloys, short chipping	-400	AlZnMgCu 1,5	3.4365	
			G-AlSi 12	3.2581	
Kupfer-Legierungen, langspanend	Copper alloys, long chipping	150-250 (160-230 HB)	MS63	2.0320	
			CuAl10Ni	2.0975	
Kupfer-Legierungen, kurzspanend	Copper alloys, short chipping	-500	MS58	2.0402	
Magnesium-Legierungen	Magnesium alloys	160-300	G-MgAl9Zn1	3.5912	
Thermoplaste	Thermoplastics	350-700 (150-280 HB)	PVC, Acrylglas PVC, acrylic glass		
Duroplaste	Duroplastics	20-40	Bakelit, Melamin		
Graphit	Graphite		Graphite	R8510	
Titan-Legierungen, mittelfest	Titanium alloys, medium strength	-950	TiAl5Sn2,5	3.7115	
			TiAl6V4	3.7165	
Titan-Legierungen, hochfest	Titanium alloys, high strength	900-140	TiAl6Sn2	3.7174	
Nickelbasis-Legierungen, mittelfest	Nickel based alloys, medium strength	-950	NiCr12Al6MoNb	2.4670	
Nickel-Basis-Legierungen, hochwarmfest	Heat resistant nickel based alloys, high strength	900-1400	NiCr19Fe19NbMo Inconel 718		
Hartguss	Chilled cast iron	300-600	Ni-hard, Ampco		
Gehärteter Stahl	Hardened steel	45-52 HRC 53-59 HRC			

* mit innerer Kühlmittelzufuhr, Drallwinkel 30° with internal coolant features, helix angle 30°

Typenbeschreibung Type description

Fräser für allgemeine Bearbeitung Milling Cutters for general machining

		DIN (WN= Werknorm FETTE Standard)	HM-Sorte Carbide Grade	Drallwinkel Helix angle λ	Schaft Shank DIN	Kat.-Nr. Cat.-No.	Kat.-Nr. Cat.-No.	Seite Page
						unbe- schichtet uncoated	AL2 Plus	
	Langlochfräser, Typ N stirnseitig bis Mitte schneidend, Zweischneider Slotting End Mills, Type N Center cutting 2-Flute	6527A/ 6528	LW630 LC630T	0°	6535HA	1481	1481C	276
	Bohrnutenfräser, Typ N, kurz und lang stirnseitig bis Mitte schneidend Zweischneider mit Untermaßen und Zwischenabmessungen Slotting End Mills, Type N, short and long Center cutting 2-Flute with under-size and intermediate dimensions	6527A 6527B	LW630 LC630T	30°	6535HA 6535HB	1426 1425	1426C 1425C	276
	Schaftfräser, Typ N, kurz und lang stirnseitig bis Mitte schneidend Dreischneider mit Zwischenabmessungen End Mills, Type N, short and long Center cutting 3-Flute with intermediate dimensions wahlweise mit innerer Kühlmittelzufuhr also with internal coolant supply	6527A/ 6528 6527B	LW630 LC630T	30°	6535HA 6535HB	1428 1429	1428C 1429C	277
	Schaftfräser, Typ N, kurz stirnseitig bis Mitte schneidend Dreischneider, zum Fräsen von Paßfedernuten mit konischem Schneidenteil für passgenaue Nuten End Mills, Type N, short Center cutting, 3-Flute, for milling of driving keyways, with tapered cutting portion to milling tight and form-true types of fits	WN	LC630T	30°	6535HB		1460C	277
	Schaftfräser, Typ SN45, lang stirnseitig bis Mitte schneidend Dreischneider End Mills, Type SN45, long Center cutting 3-Flute Kantenschutzfase Edge protection chamfer	6527A/ 6528 6527B 6527B	LW630 LC630T	45°	6535HA 6535HB 6535HB	1461 1462 1464	1461C 1462C 1464C	278

Typenbeschreibung Type description

Fräser für allgemeine Bearbeitung Milling Cutters for general machining

		DIN (WN = Werknorm FETTE Standard)	HM-Sorte Carbide Grade	Drallwinkel Helix angle λ	Schaft Shank DIN	Kat.-Nr. Cat.-No.	Kat.-Nr. Cat.-No.	Seite Page
						unbe- schichtet uncoated	AL2 Plus	
	Schaftfräser, Typ N, kurz und lang stirnseitig bis Mitte schneidend Vierschneider mit Zwischenabmessungen	6527A/ 6528	LW630 LC630T	30°	6535HA	1585	1585C	279
	End Mills, Type N, short and long Center cutting 4-Flute with intermediate dimensions	6527B			6535HB	1584	1584C	
	Schaftfräser, Typ SN45, lang und extra lang stirnseitig bis Mitte schneidend Mehrschneider	6527A/ 6528	LW630 LC630T	45°	6535HA	1528	1528C	280
			LT215 (Cermet)			1578		
	End Mills, Type SN45, long and extra long Center cutting Multiple Flute	6527B	LW630 LC630T		6535HB	1529	1529C	
			LT215 (Cermet)		1579			
	Chip Master Schaftschruppfräser, Typ RFT30, lang stirnseitig bis Mitte schneidend Vierschneider	6527A/ 6528	LC630T	25°	6535HA		1591C	281
	Chip Master End Mills, Type RFT30, long Center cutting 4-Flute	6527B				6535HB	1592C	
	Chip Master Schaftschruppfräser, Typ RFT45, lang stirnseitig bis Mitte schneidend Drei- und Vierschneider	6527A/ 6528	LC630T	45°	6535HA		1563C	281
	Chip Master Roughing End Mills, Type RFT45, long Center cutting 3- and 4-Flute	6527B				6535HB	1564C	
	Chip Master Schaftschruppfräser, Typ RFT30, lang stirnseitig bis Mitte schneidend Dreischneider	6527A	LC630T	30°	6535HA		1574C	281
	Chip Master End Mills, Type RFT30, long Center cutting 3-Flute mit innerer Kühlmittelzufuhr with internal coolant supply	6527B				6535HB	1575C	
	Schaftfräser, Typ NVT, lang stirnseitig bis Mitte schneidend Vierschneider Schrupp-Schlichtausführung mit ingeschliffenen Spanteilern	6527A/ 6528	LW630 LC630T	25°	6535HA	1598	1598C	282
	End Mills, Type NVT, long Center cutting 4-Flute Roughing-finishing version with ground chipbreakers	6527B				6535HB	1599	

Vollhartmetall
stirnseitig bis Mitte schneidend
NC-gerecht

Solid Carbide
center cutting
suitable for NC

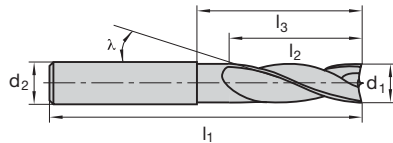

Katalog-Nr.	Cat.-No.	1481	1481 C	1426	1426 C	1425	1425 C
Typ	Type	N					
Norm	Standard	DIN 6527 A / DIN 6528				DIN 6527 B	
Drallwinkel	Helix angle	$\lambda = 0^\circ$			$\lambda = 30^\circ$		
Zylinderschaft	Straight shank	DIN 6535 HA				DIN 6535 HB	
Beschichtung	Coating	-	AL2 Plus	-	AL2 Plus	-	AL2 Plus
Schneidstoffsorten ¹⁾	Cutting materials ¹⁾	LW630	LC630T	LW630	LC630T	LW630	LC630T

d ₁ e 8	l ₂	l ₁	l ₃	d ₂ h 6	Ident No.	Ident No.	Ident No.	Ident No.	Ident No.	Ident No.
kurz short										
2	3	50	14	6	-	-	1120080	1122346	1120082	1100091
3	4	50	14	6	-	-	1120081	1122358	1120083	1100092
4	5	54	18	6	-	-	1300000	1122370	1122405	1100093
4,8 ²⁾	6	54	18	6	-	-	1300001	1122382	1112659	-
5	6	54	18	6	-	-	1300002	1122394	1122414	1100094
5,75 ²⁾	7	54	18	6	-	-	1300003	1122407	1112641	-
6	7	54	18	6	-	-	1300004	1122420	1122423	1100095
7,75 ²⁾	9	58	22	8	-	-	1300005	1122434	1112645	-
8	9	58	22	8	-	-	1300006	1122447	1122432	1100096
9,7	11	66	26	10	-	-	1300007	1122460	1112650	-
10	11	66	26	10	-	-	1300008	1122473	1122441	1100097
11,7	12	73	28	12	-	-	1300009	1122486	1112652	-
12	12	73	28	12	-	-	1300010	1122498	1122450	1100098
16	16	82	34	16	-	-	1300011	1122522	1122469	1100099
20	20	92	42	20	-	-	1300012	1122534	1122478	1100100
lang long										
2	6	38	10	3	1112103	1122179	1112202	1122246	-	-
3	7	38	10	3	1112112	1122193	1112203	1122258	-	-
4	8	50	22	4	1112121	1122205	1112205	1122271	-	-
5	10	50	22	5	1112130	1122219	1112207	1122285	-	-
6	10	57	21	6	1112149	1122232	1112209	1122298	1112210	1100117
7	13	60	24	7	-	-	1112211	1122311	-	-
7	13	63	27	8	-	-	1110115	1110124	1110110	1110119
8	16	63	27	8	1112167	1122257	1112213	1122323	1112229	1100118
9	16	67	31	9	-	-	1112215	1122335	-	-
9	16	72	32	10	1112185	1122284	1110116	1110125	1110111	1110120
10	19	72	32	10	-	-	1112217	1122347	1112238	1100119
11	22	83	38	12	1112201	1122310	1110117	1110126	1110112	1110121
11	22	83	43	11	-	-	1112219	1122359	-	-
12	22	83	38	12	-	-	1112221	1122371	1112247	1100120
14	22	83	38	14	1121203	1122322	1112223	1122383	1112283	1100121
15	26	92	44	16	-	-	1110118	1110127	1110113	1110122
15	26	92	44	15	-	-	1112225	1122395	-	-
16	26	92	44	16	1112208	1122334	1112227	1122408	1112256	1100122
18	26	92	44	18	-	-	1112279	1122421	1112285	1100123
20	32	104	54	20	-	-	1112281	1122435	1112265	1100124

¹⁾ Sortenbeschreibung siehe Seite 22
¹⁾ Description of grades see page 22

²⁾ Toleranz h10
²⁾ Tolerance h10

Schnittwertempfehlungen ab Seite 286
 Cutting data recommendations starting page 286

**Vollhartmetall
stirnseitig bis Mitte schneidend
NC-gerecht**

**Solid Carbide
center cutting
suitable for NC**

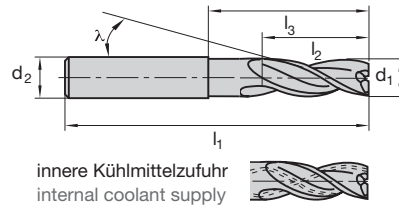

Katalog-Nr.	Cat.-No.	1428	1428 C	1429	1429 C	1460 C
Typ	Type	N				
Norm	Standard	DIN 6527 A / DIN 6528		DIN 6527 B		Fette Standard
Drallwinkel	Helix angle	$\lambda = 30^\circ$				
Zylinderschaft	Straight shank	DIN 6535 HA		DIN 6535 HB		
Beschichtung	Coating	-	AL2 Plus	-	AL2 Plus	
Schneidstoffsorten ¹⁾	Cutting materials ¹⁾	LW630	LC630T	LW630	LC630T	LC630T
Besonderheiten	Special features	-				konischer Schneidteil ³⁾ tapered cutting portion ³⁾

d ₁ e 8	l ₂	l ₁	l ₃	d ₂ h 6	Ident No.	Ident No.	Ident No.	Ident No.	Ident No.
kurz short									
4	5	54	18	6	1300044	1122116	1143402	1100171	-
4,8	6	54	18	6	-	-	-	-	1121963
5	6	54	18	6	1300045	1122128	1143403	1100172	-
5,75	6	54	18	6	-	-	-	-	1121964
6	7	54	18	6	1300046	1122142	1143404	1100173	-
7,75	9	58	22	8	-	-	-	-	1121965
8	9	58	22	8	1300047	1122155	1143405	1100174	-
9,7	11	66	26	10	-	-	-	-	1121966
10	11	66	26	10	1300048	1122168	1143406	1100175	-
11,7	12	73	28	12	-	-	-	-	1121967
12	12	73	28	12	1300049	1122181	1143407	1100176	-
13,7	14	75	30	14	-	-	-	-	1121968
14	14	75	30	14	1300050	1122195	1143408	1100177	-
15,7	16	82	34	16	-	-	-	-	1121970
16	16	82	34	16	1300051	1122207	1143409	1100178	-
18	18	84	36	18	1300053	1122221	1143410	1100179	-
20	20	92	42	20	1300054	1122234	1143411	1100180	-
lang long									
2	6	38	10	3	1140617	1122007	-	-	-
3	7	38	10	3	1140626	1122020	-	-	-
4	8	50	22	4	1140635	1122034	-	-	-
5	10	50	22	5	1140644	1122046	-	-	-
6	10	57	21	6	1140653	1122060	1143371	1100181	-
7	13	60	24	6	1140662	1122073	-	-	-
7	13	63	27	8	1110101	1110106	1110096	1110092	-
8	16	63	27	8	1140671	1122087	1143373	1100182	-
8	16	63	27	8	-	1110022 ²⁾	-	1110028 ²⁾	-
9	16	67	31	9	1140680	1122100	-	-	-
9	16	72	32	10	1110102	1110107	1110097	1110093	-
10	19	72	32	10	1140699	1122113	1143375	1100183	-
10	19	72	32	10	-	1110023 ²⁾	-	1110029 ²⁾	-
11	22	83	43	11	1140715	1122125	-	-	-
11	22	83	38	12	1110103	1110108	1110099	1110094	-
12	22	83	38	12	1140724	1122139	1143377	1100184	-
12	22	83	38	12	-	1110024 ²⁾	-	1110030 ²⁾	-
14	26	83	38	14	1140733	1122152	1143450	1100185	-
15	26	92	47	15	1140742	1122164	-	-	-
15	26	92	44	16	1110104	1110109	1110100	1110095	-
16	26	92	44	16	1140751	1122178	1143379	1100186	-
16	26	92	44	16	-	1110026 ²⁾	-	1110031 ²⁾	-
18	32	92	44	18	1140760	1122191	1143452	1100187	-
20	32	104	54	20	1140779	1122204	1143381	1100188	-
20	32	104	54	20	-	1110027 ²⁾	-	1110032 ²⁾	-

¹⁾ Sortenbeschreibung siehe Seite 22

²⁾ mit innerer Kühlmittelzufuhr

¹⁾ Description of grades see page 22

²⁾ with internal coolant supply

³⁾ zur Verbesserung des Verschleißverhaltens, zum Fräsen von Paßfedernuten

³⁾ to milling tight and form-true types of fits, for milling of driving keyways

Vollhartmetall
stirnseitig bis Mitte schneidend
NC-gerecht

Solid Carbide
center cutting
suitable for NC

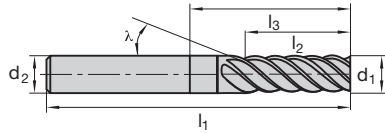

Katalog-Nr.	Cat.-No.	1461	1461 C	1462	1462 C	1464	1464 C	
Typ	Type	SN 45						
Norm	Standard	DIN 6527 A / DIN 6528		DIN 6527 B		DIN 6527 A / DIN 6528		
Drallwinkel	Helix angle	$\lambda = 45^\circ$						
Zylinderschaft	Straight shank	□ DIN 6535 HA		□ DIN 6535 HB				
Beschichtung	Coating	-	AL2 Plus	-	AL2 Plus	-	AL2 Plus	
Schneidstoffsorten ¹⁾	Cutting materials ¹⁾	LW630	LC630T	LW630	LC630T	LW630	LC630T	
Besonderheiten	Special features	-					Kantenschutzfase Edge protection chamfer	

d ₁ h 8	l ₂	l ₁	l ₃	d ₂ h 6	Ident No.	Ident No.	Ident No.	Ident No.	Ident No.	Ident No.
3	8	57	18	6	1128643	1128654	1128665	1128676	-	-
4	11	57	19	6	1128644	1128655	1128666	1128677	-	-
5	13	57	19	6	1128645	1128656	1128667	1128678	-	-
6	13	57	21	6	1128646	1128657	1128668	1128679	1128692	1128702
8	19	63	27	8	1128647	1128658	1128669	1128680	1128693	1128703
10	22	72	32	10	1128648	1128659	1128670	1128681	1128694	1128704
12	26	83	38	12	1128649	1128660	1128671	1128682	1128695	1128705
14	26	83	38	14	1128650	1128661	1128672	1128683	1128696	1128706
16	32	92	44	16	1128651	1128662	1128673	1128684	1128697	1128707
18	32	92	44	18	1128652	1128663	1128674	1128685	1128698	1128708
20	38	104	54	20	1128653	1128664	1128675	1128686	1128699	1128709

Kantenschutzfase Edge protection chamfer		
	d ₁	b
	6 - 12	0,2
	14 - 20	0,3

¹⁾ Sortenbeschreibung siehe Seite 22
¹⁾ Description of grades see page 22

Schnittwertempfehlungen ab Seite 286
Cutting data recommendations starting page 286

Vollhartmetall
stirnseitig bis Mitte schneidend
NC-gerecht

Solid Carbide
center cutting
suitable for NC

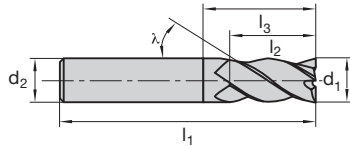

Katalog-Nr.	Cat.-No.	1585	1585 C	1584	1584 C
Typ	Type	N			
Norm	Standard	DIN 6527 A / DIN 6528		DIN 6527 B	
Drallwinkel	Helix angle	$\lambda = 30^\circ$			
Zylinderschaft	Straight shank	□ DIN 6535 HA		□ DIN 6535 HB	
Beschichtung	Coating	-	AL2 Plus	-	AL2 Plus
Schneidstoffsorten ¹⁾	Cutting materials ¹⁾	LW630	LC630T	LW630	LC630T

d ₁ h 10	l ₂	l ₁	l ₃	d ₂ h 6	Ident No.	Ident No.	Ident No.	Ident No.
kurz short								
4	8	54	18	6	1120214	1122871	1120215	1100206
6	10	54	18	6	1300027	1122584	1143359	1100207
8	12	58	22	8	1300028	1122596	1143361	1100208
10	14	66	26	10	1300029	1122608	1143363	1100209
12	16	73	28	12	1300030	1122620	1143365	1100210
14	18	75	30	14	1300031	1122633	1143430	1100211
16	22	82	34	16	1300032	1122645	1143367	1100212
18	24	84	36	18	1300033	1122658	1143432	1100213
20	26	92	42	20	1300034	1122670	1143369	1100214
lang long								
4	11	50	22	4	1142765	1122422	-	-
5	13	50	22	6	1142767	1122436	-	-
6	57	50	21	6	1142769	1122449	1142704	1100215
7	16	60	24	7	1142771	1122462	-	-
7	16	63	27	8	1110085	1110088	1110081	1110077
8	19	63	27	8	1142773	1122475	1142713	1100216
9	19	67	31	9	1142775	1122488	-	-
9	19	72	32	10	1110086	1110090	1110082	1110078
10	22	72	32	10	1142776	1122500	1142722	1100217
11	26	83	38	12	1110087	1110091	1110083	1110079
11	26	83	38	11	1142778	1122524	-	-
12	26	83	38	12	1142780	1122536	1142731	1100218
14	26	83	38	14	1142783	1122548	1142608	1100219
16	32	92	44	16	1142785	1122560	1142740	1100220
18	32	92	44	18	1142787	1122572	1142610	1100221
20	38	104	54	20	1142789	1122585	1142759	1100222
25	45	121	65	25	-	-	1110084	1110080

¹⁾ Sortenbeschreibung siehe Seite 22
¹⁾ Description of grades see page 22

Schnittwertempfehlungen ab Seite 286
 Cutting data recommendations starting page 286

Schafffräser, lang und extra lang End Mills, long and extra long

**Vollhartmetall Cermet
NC-gerecht**

**Solid Carbide Cermet
suitable for NC**

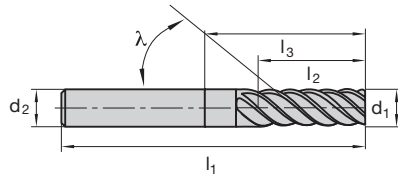

Katalog-Nr.	Cat.-No.	1578	1528	1528 C	1579	1529	1529 C
Typ	Type	SN 45°					
Norm	Standard	DIN 6527 A / DIN 6528			DIN 6527 B		
Drallwinkel	Helix angle	λ = 45°					
Zylinderschaft	Straight shank	□ DIN 6535 HA			□ DIN 6535 HB		
Beschichtung	Coating	-		AL2 Plus	-		AL2 Plus
Schneidstoffsorten ¹⁾	Cutting materials ¹⁾	LT215 ³⁾	LW630	LC630T	LT215 ³⁾	LW630	LC630T

d ₁ h 10	l ₂	l ₁	l ₃	d ₂ h 6	z	Ident No.	Ident No.	Ident No.	Ident No.	Ident No.	Ident No.
lang long											
6	13	57	21	6	6	1300118	1120223	1122051	1142669	1120230	1100224
8	19	63	27	8	6	1300119	1120224	1122064	1142671	1120231	1100225
10	22	72	32	10	6	1300120	1120225	1122078	1142673	1120232	1100226
12	26	83	38	12	6	1300121	1120226	1122091	1142675	1120233	1100227
16	32	92	44	16	6	1300122	1120227	1122105	1142677	1120234	1100228
20	38	104	54	20	8	1300131	1120228	1122117	1142680	1120235	1100229
extra lang ²⁾ extra long ²⁾											
4	19	63	27	6	4	-	-	1301010	-	-	1301000
6	24	68	32	6	4	-	-	1301011	-	-	1301001
8	38	82	46	8	4	-	-	1301012	-	-	1301002
10	45	95	57	10	4	-	-	1301013	-	-	1301003
12	53	110	65	12	4	-	-	1301014	-	-	1301004
16	63	123	75	16	4	-	-	1301015	-	-	1301005
20	75	141	91	20	8	-	-	1301016	-	-	1301006
25	90	166	110	25	10	-	-	1301017	-	-	1301007

¹⁾ Sortenbeschreibung siehe Seite 22
¹⁾ Description of grades see page 22

²⁾ Baumaße ≈ DIN 844
²⁾ Structural dimensions ≈ DIN 844

³⁾ Cermet
³⁾ Cermet

Schnittwertempfehlungen ab Seite 286
Cutting data recommendations starting page 286

**Vollhartmetall stirnseitig bis Mitte schneidend
hinterschliffen
NC-gerecht**

**Solid Carbide
center cutting
relief ground
suitable for NC**

innere Kühlmittelzufuhr
internal coolant supply

RFT25
RFT45
RFT30

Katalog-Nr.	Cat.-No.	1591 C	1592 C	1563 C	1564 C	1574 C	1575 C
Typ	Type	RFT25		RFT45		RFT30	
Norm	Standard	DIN 6527 A / DIN 6528	DIN 6527 B	DIN 6527 A / DIN 6528	DIN 6527 B	DIN 6527 A / DIN 6528	DIN 6527 B
Drallwinkel	Helix angle	$\lambda = 25^\circ$		$\lambda = 45^\circ$		$\lambda = 30^\circ$	
Zylinderschaft	Straight shank						
Beschichtung	Coating	AL2 Plus					
Schneidstoffsorten ¹⁾	Cutting materials ¹⁾	LC630T					

d ₁ h 10	l ₂	l ₁	l ₃	d ₂ h 6	z	Ident No.	Ident No.	Ident No.	Ident No.	Ident No.	Ident No.
6	13	57	21	6	3	-	-	1123000	1123010	-	-
8	19	63	27	8	3	-	-	1123001	1123012	1110128 ²⁾	1110033 ²⁾
8	19	63	27	8	4	1121926	1121934	-	-	-	-
10	22	72	32	10	3	-	-	-	-	1110129 ²⁾	1110035 ²⁾
10	22	72	32	10	4	1121927	1121935	1123003	1123013	-	-
12	26	83	38	12	3	-	-	-	-	1110130 ²⁾	1110036 ²⁾
12	26	83	38	12	4	1121928	1121936	1123004	1123014	-	-
14	26	83	38	14	4	1121929	1121937	1123005	1123015	-	-
16	32	92	44	16	3	-	-	-	-	1110131 ²⁾	1110037 ²⁾
16	32	92	44	16	4	1121930	1121938	1123006	1123016	-	-
18	32	92	44	18	4	1121931	1121939	1123007	1123017	-	-
20	38	104	54	20	3	-	-	-	-	1110133 ²⁾	1110038 ²⁾
20	38	104	54	20	4	1121933	1121940	1123008	1123018	-	-
25	45	121	65	25	4	1122005	1122004	-	-	-	-

Anwendungsbeispiel
Application example

Konturbearbeitung am Bremsträger aus GGG60
Machining of outlines of a brake anchor plate of GGG60

Werkzeug Tool:
CHIPMaster-Schaftfräser, Kat.-Nr. 1591C
CHIPMaster-End Mills, Cat.-No. 1591C
d₁ = 16 mm, z = 4
LC630T
AL2 Plus-Beschichtung Coating

Schnittwerte Cutting Data:
v_c = 110 m/min n = 2190 min⁻¹
v_f = 876 mm/min f_z = 0,1 mm
a_e = 1-4 mm a_p = 12 mm

Ergebnis:
Reduzierung der Bearbeitungszeit gegenüber einem vergleichbaren HSS-Schruppfräser von 0,51 min auf 0,11 min.
Die Kosten reduzieren sich auf 0,44 € gegenüber 1,18 €

Result:
Reduction of the machining time in contrast to a comparable HSS roughing end mill from 0.51 min down to 0.11 min.
The cost is reduced to 0.44 € in comparison with 1.18 €

Kosteneinsparung von 88.000 € bei der Jahresproduktion von 120.000 Teilen.
A cost saving of 88,000 € over an annual production of 120,000 parts.

¹⁾ Sortenbeschreibung siehe Seite 22
¹⁾ Description of grades see page 22

²⁾ mit innerer Kühlmittelzufuhr
²⁾ with internal coolant supply

Schnittwertempfehlungen ab Seite 286
Cutting data recommendations starting page 286

Vollhartmetall
stirnseitig bis Mitte schneidend
hinterschliffen
NC-gerecht

Solid Carbide center cutting
relief ground
suitable for NC

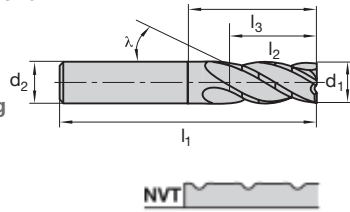

Katalog-Nr.	Cat.-No.	1598	1598 C	1599	1599 C
Typ	Type	NVT			
Norm	Standard	DIN 6527 A / DIN 6528		DIN 6527 B	
Drallwinkel	Helix angle	$\lambda = 25^\circ$			
Zylinderschaft	Straight shank	DIN 6535 HA		DIN 6535 HB	
Beschichtung	Coating	-	AL2 Plus	-	AL2 Plus
Schneidstoffsorten ¹⁾	Cutting materials ¹⁾	LW630	LC630T	LW630	LC630T

d ₁ h 10	l ₂	l ₁	l ₃	d ₂ h 6	Ident No.	Ident No.	Ident No.	Ident No.
6	13	57	21	6	1300065	1122325	1142868	1100230
8	19	63	27	8	1300066	1122337	1142870	1100231
10	22	72	32	10	1300067	1122349	1142873	1100232
12	26	83	38	12	1300068	1122361	1142875	1100233
16	32	92	44	16	1300071	1122385	1142877	1100235
18	32	92	44	18	-	-	1100236	1142890
20	38	104	54	20	1300073	1122410	1142879	1100237
25	45	121	65	25	1300074	1122424	1142892	1100238

¹⁾ Sortenbeschreibung siehe Seite 22
¹⁾ Description of grades see page 22

Schnittwertempfehlungen ab Seite 286
Cutting data recommendations starting page 286

**Vollhartmetall hinterschliften
stirnschneidend
4 Zähne**

**Solid carbide relief ground
end cutting
4 teeth**

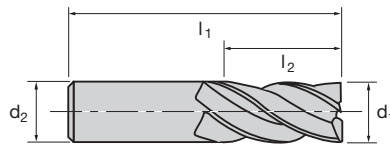

Katalog-Nr.	Cat.-No.	150
Typ	Type	N
Norm	Standard	LMT-Standard
Drallwinkel	Helix angle	25°
Zylinderschaft	Straight shank	DIN 6535 HA
Beschichtung	Coating	auf Anfrage on request
Schneidstoffsorten ¹⁾	Cutting materials ¹⁾	

d_1 -0,03 - 0,08	d_2 h6	l_2	l_1	Ident No.
1	3	4	38	15010
1,5	3	4,5	38	15015
2	2	7	40	15020
2	3	6,3	35	15020A
2,5	3	9	38	15025A
3	3	10	40	15030
3,5	3,5	10	40	15035
4	4	11	48	15040
4,5	4,5	11	48	15045
5	5	13	60	15050
5,5	5,5	13	60	15055
6	6	16	60	15060
7	7	20	60	15070
8	8	23	60	15080
9	9	23	60	15090
10	10	30	75	15100
12	12	30	75	15120
13	13	30	76	15130
14	14	30	76	15140
15	15	30	76	15150
16	16	32	80	15160
18	18	32	80	15180
20	20	38	90	15200

**Vollhartmetall stirnschneidend
hinterschliffen**

**Solid carbide end cutting
relief ground**

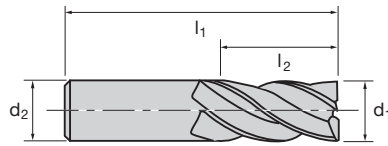

Katalog-Nr.	Cat.-No.	171
Typ	Type	N
Norm	Standard	LMT-Standard
Drallwinkel	Helix angle	20°
Zylinderschaft	Straight shank	DIN 6535 HA
Beschichtung	Coating	auf Anfrage on request
Schneidstoffsorten ¹⁾	Cutting materials ¹⁾	

d_1 -0,03 – 0,08	d_2	l_2	l_1	Ident No.
2	2	8	38	171020
3	3	12	43	171030
4	4	16	48	171040
5	5	20	53	171050
6	6	24	65	171060
8	8	32	75	171080
10	10	40	90	171100
12	12	42	100	171120
14	14	50	100	171140
16	16	55	120	171160
18	18	55	120	171180
20	20	55	120	171200

Alle Materialien
All types of materials

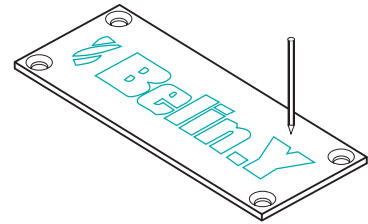

	Ident No.		Ident No.
	91096		92175
	00177		92175
	91097		92176
	00178		92176
	91098		94161
	00179		00185
	91099		94162
	00180		00186
	91100		94163
	00181		00187
	91101		
	00182		

Fräser Mills DR-P: 12000 bis/to 30000 min⁻¹ Vorgeschlagene Geschwindigkeit advised speed
 FI-GR : 10000 min⁻¹ Minimum Geschwindigkeit minimum speed
 20000 bis/to 40000 min⁻¹ Vorgeschlagene Geschwindigkeit advised speed

Werkstoff	Material	Rm/UTS (N/mm²)	Beispiel Example	DIN-No.
Unlegierter Baustahl	Plain carbon steel	-700	St 52	1.0052
Automatenstahl	Free cutting steel	-700	9 SMn 28	1.0715
Baustahl	Structural alloy steel	500-950	Ck 45 26 CrMo 4	1.1191 1.7219
Vergütungsstahl, mittelfest	Heat-treatable steel, medium strength	500-950	42 CrMo 4 50 CrV 4	1.7225 1.2241
Stahlguss	Cast steel	-950	GS 40	1.0416
Einsatzstahl	Case hardening steel	-950	16 MnCr 5	1.7131
Rost- und säurebeständiger Stahl, ferritisch, martensitisch	Stainless steel, ferritic, martensitic	500-950	X 10 Cr 13 X 12 CrMoS 17 X 35 CrMo 17	1.4006 1.4104 1.4122
Vergütungsstahl, hochfest	Heat-treatable steel, high strength	950-1400	42 CrMo 4 30 CrNiMo 8	1.7225 1.6580
Nitrierstahl, vergütet	Nitriding steel	950-1400	34 CrAl 6	1.8504
Werkzeugstahl	Tool steel	950-1400	X 38 CrMoV 5 1 X 155 CrVMo 12 1	1.2343 1.2379
Rost- und säurebeständiger Stahl, austenitisch	Stainless steel, austenitic	500-950	X 5 CrNi 18 10 X10 CrNiMo 18 10	1.4301 1.4571
Martensitaushärtbarer Stahl	Maraging steel			1.2709
Grauguss	Grey cast iron	-550	GG25	0.6025
Legierter Grauguss	Alloyed grey cast iron	300-700	GGL-NiCr 35 2	0.6678
Sphäroguss	Nodular cast iron	-500	GGG60	0.7060
Temperguss	Malleable cast iron	40-70	GTS55	0.8155
Rein-Metalle, weich	Pure metals, soft	400-800 (120-310 HB)	Reineisen, Blei pure iron, lead	1.1003
Aluminium-Legierungen, langspanend	Aluminium alloys, long chipping	100-400 (120-260 HB)	AlMg 3 AlZnMgCu 1,5	3.3535 3.4365
Aluminium-Legierungen, kurzspanend	Aluminium alloys, short chipping	-400	G-AlSi 12	3.2581
Kupfer-Legierungen, langspanend	Copper alloys, long chipping	150-250 (160-230 Hb)	MS63 CuAl10Ni	2.0320 2.0975
Kupfer-Legierungen, kurzspanend	Copper alloys, short chipping	-500	MS58	2.0402
Magnesium-Legierungen	Magnesium alloys	160-300	G-MgAl9Zn1	3.5912
Thermoplaste	Thermoplastics	350-700 (150-280 HB)	PVC, Acrylglas PVC, acrylic glass	
Duroplaste	Duroplastics	20-40	Bakelit, Melamin	
Graphit	Graphite		Graphite	R8510
Titan-Legierungen, mittelfest	Titanium alloys, medium strength	-950	TiAl5Sn2,5 TiAl6V4	3.7115 3.7165
Titan-Legierungen, hochfest	Titanium alloys, hight strength	900-140	TiAl6Sn2	3.7174
Nickelbasis-Legierungen, mittelfest	Nickel based alloys, medium strength	-950	NiCr12Al6MoNb	2.4670
Nickel-Basis-Legierungen, hochwarmfest	Heat resistant nickel based alloys, high strength	900-1400	NiCr19Fe19NbMo Inconel 718	
Hartguss	Chilled cast iron	300-600	Ni-hard, Ampco	Ampco 25
Gehärteter Stahl	Hardened steel	45-52 HRC 53-59 HRC		

	Schnittgeschwindigkeit Cutting speed $v_c = \text{m/min}$		Cermet	Vorschub pro Zahn Feed per tooth $f_z [\text{mm/z.}]$				Leistungsfaktor Efficiency factor $\text{LF} = \frac{\text{cm}^3}{\text{min} \cdot \text{kW}}$
	Hartmetall Carbide			$\varnothing 2-4$	$\varnothing 5-10$	11-16	$\varnothing >16$	
	beschichtet coated	unbeschichtet uncoated						
	230	185	300	0,03	0,06	0,09	0,15	24
	230	185	300	0,03	0,06	0,09	0,15	22
	200	160	280	0,025	0,06	0,08	0,14	20
	140	110	200	0,025	0,05	0,08	0,14	18
	120	95	160	0,02	0,04	0,07	0,13	18
	140	110	180	0,03	0,05	0,08	0,14	18
	80	65	-	0,015	0,035	0,07	0,1	16
	110	90	150	0,015	0,04	0,06	0,12	16
	100	80	130	0,015	0,04	0,06	0,12	16
	100	80	130	0,015	0,04	0,06	0,12	14
	60	50	-	0,013	0,035	0,05	0,08	18
	80	65	-	0,013	0,035	0,05	0,08	18
	180	145	220	0,03	0,07	0,1	0,15	30
	160	130	180	0,025	0,06	0,09	0,14	22
	150	120	150	0,02	0,06	0,09	0,14	24
	120	95	130	0,02	0,06	0,09	0,14	24
	400	320	-	0,02	0,04	0,08	0,14	50
	1000	800	-	0,03	0,06	0,1	0,15	60
	300	240	-	0,03	0,06	0,1	0,15	55
	300	240	-	0,025	0,05	0,09	0,14	50
	250	200	-	0,025	0,05	0,09	0,14	35
	400	320	-	0,03	0,06	0,09	0,14	50
	250	200	-	0,03	0,06	0,1	0,15	70
	350	280	-	0,025	0,05	0,1	0,15	35
	400	320	500	0,04	0,08	0,15	0,2	90
	70	55	-	0,015	0,03	0,05	0,09	20
	40	30	-	0,01	0,03	0,05	0,09	16
	30	25	-	0,01	0,03	0,05	0,09	18
	20	15	-	0,01	0,03	0,05	0,09	15
	50	40	-	0,01	0,03	0,05	0,09	24
	80-160	65-130	-	0,01	0,03	0,05	0,09	12

Drehzahl Speed	Vorschubgeschwindigkeit Feed rate	
$n = \frac{v_c \cdot 1000}{\pi \cdot d_1}$	$v_f = f_z \cdot z \cdot n \cdot f_2$	
v_c Tab. Seite 286 Page 286	f_z Tab. Seite 286 Page 286	
Spanvolumen Chip volume	Antriebsleistung Drive power	
$Q = \frac{a_e \cdot a_p \cdot v_f}{1000}$	$P_e \approx \frac{Q}{LF}$	

a_e = Schnittbreite in mm
Width of cut in mm
 a_p = Schnitttiefe in mm
Depth of cut in mm
 d_1 = Durchmesser in mm
Cutter diameter in mm
 f_2 = Korrekturfaktor für v_f
Correction factor for v_f
 f_z = Vorschub pro Zahn in mm
Feed per tooth in mm
 LF = Leistungsfaktor in $\text{cm}^3/\text{min}/\text{kW}$
Efficiency factor in $\text{cm}^3/\text{min}/\text{kW}$
 n = Drehzahl in min^{-1}
Speed in min^{-1}
 P_e = Antriebsleistung in kW
Drive power in kW
 Q = Spanvolumen in cm^3/min
Chip volume in cm^3/min
 v_c = Schnittgeschwindigkeit in m/min
Cutting speed in m/min
 v_f = Vorschubgeschwindigkeit in mm/min
Feed rate in mm/min
 z = Anzahl der Schneiden
No. of teeth
 λ = Drall \ddagger
Helix \ddagger

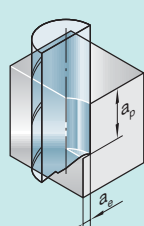
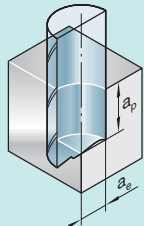
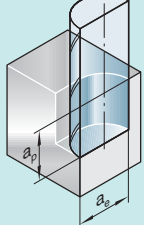
Vorschub-Korrektur-Faktoren f_2 für VHM-Schaftfräser Feed Correction Factor f_2 for Solid Carbide End Mills					
$v_f = n \cdot z \cdot f_z \cdot f_2$					
	a_e	λ	$a_p \approx$	f_2	
				Typ N/SN	Typ RFT
	$0,1 \cdot d_1$	$25-30^\circ$	$1,5 \cdot d_1$	1	1,2
		45°	$1,5 \cdot d_1$	1,5	1,7
	$0,5 \cdot d_1$	$25-30^\circ$	$1 \cdot d_1$	0,6	0,8
		45°	$1 \cdot d_1$	0,9	1,1
	$1 \cdot d_1$	$25-30^\circ$	$0,5 \cdot d_1$	0,4	0,6
		45°	$0,8 \cdot d_1$ $0,5 \cdot d_1$	0,4 0,6	0,6 0,8





Gewindefräser, Fräser mit eingelöteten HM-Schneiden

Thread Milling Cutters, Cutters with brazed carbide tips

Auswahlübersicht Selection table	292, 293, 294
Typenbeschreibung Type description	295, 296
Gewindefräser Thread Milling Cutters	297
Gewindefräser mit Senker Thread Milling Cutters with Counterbore	298
Bohrgewindefräser Combined Drilling and Thread Milling Cutters	299
Walzenstirnfräser Shell End Mills	300
Scheibenfräser Side Milling Cutters	301
Langlochfräser, Zweischneider Slotting End Mills, 2 Flutes	302
Schaftfräser, kurz End Mills, short	303
Schnittwertempfehlungen Cutting data recommendations	304, 306

Auswahlübersicht Selection table

Gewindefräser Thread Milling Cutters

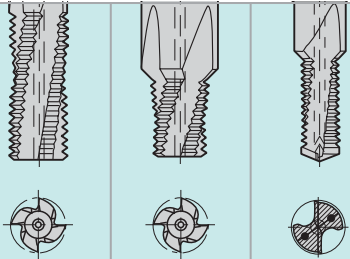
<ul style="list-style-type: none"> ● sehr gut geeignet well suited ○ auch geeignet also suited 								
						Zähnezahl No. of teeth		
Drallwinkel Helix angle								
Schneidstoffsorten Cutting material								
Seite Page								
Kat.-Nr. Cat.-No.								
1721C 1741C 1751C								
1723C 1473C								
1727C 1747C								
3-4								
2								
$\lambda = 27^\circ$								
LC630T								
297 298 299								
Werkstoff	Material	R _m /UTS (N/mm ²)	Beispiel Example	DIN-No.	1721C	1741C	1751C	
Unlegierter Baustahl	Plain carbon steel	-700	St 52	1.0052	●	●		
Automatenstahl	Free cutting steel	-700	9 SMn 28	1.0715	●	●		
Baustahl	Structural alloy steel	500-950	Ck 45, 26 CrMo 4	1.1191 1.7219	●	●		
Vergütungsstahl, mittelfest	Heat-treatable steel, medium strength	500-950	42 CrMo 4 50 CrV 4	1.7225 1.2241	●	●		
Stahlguss	Cast steel	-950	GS 40	1.0416	●	●		
Einsatzstahl	Case hardening steel	-950	16 MnCr 5	1.7131	●	●		
Rost- und säurebeständiger Stahl, ferritisch, martensitisch	Stainless steel, ferritic, martensitic	500-950	X 10 Cr 13 X 12 CrMoS 17 X 35 CrMo 17	1.4006 1.4104 1.4122	●	●		
Vergütungsstahl, hochfest	Heat-treatable steel, high strength	950-1400	42 CrMo 4 30 CrNiMo 8	1.7225 1.6580	●	●		
Nitrierstahl, vergütet	Nitriding steel	950-1400	34 CrAl 6	1.8504	●	●		
Werkzeugstahl	Tool steel	950-1400	X38 CrMoV 5 1 X 155 CrVMo 12 1	1.2343 1.2379	●	●		
Rost- und säurebeständiger Stahl, austenitisch	Stainless steel, austenitic	500-950	X 5 CrNi 18 10 X10 CrNiMo 18 10	1.4301 1.4571	●	●		
Martensitaushärtbarer Stahl	Maraging steel		X3NiCoMoTi18-9-5	1.2709	●	●		
Grauguss	Grey cast iron	-550	GG25	0.6025	●	●	●	
Legierter Grauguss	Alloyed grey cast iron	300-700	GGL-NiCr 35 2	0.6678	●	●	●	
Sphäroguss	Nodular cast iron	-500	GGG60	0.7060	●	●	●	
Temperguss	Malleable cast iron	40-70	GTS55	0.8155	●	●	●	
Rein-Metalle, weich	Pure metals, soft	400-800 (120-310 HB)	Reineisen, Blei pure iron, lead		●	●	●	
Aluminium-Legierungen, langspanend	Aluminium alloys, long chipping	100-400 (120-260 HB)	AlMg 3 AlZnMgCu 1,5	3.3535 3.4365	●	●	●	
Aluminium-Legierungen, kurzspanend	Aluminium alloys, short chipping	-400	G-AlSi 12	3.2581	●	●	●	
Kupfer-Legierungen, langspanend	Copper alloys, long chipping	150-250 (160-230 HB)	MS63 CuAl10Ni	2.0320 2.0975	●	●		
Kupfer-Legierungen, kurzspanend	Copper alloys, short chipping	-500	MS58	2.0402	●	●		
Magnesium-Legierungen	Magnesium alloys	160-300	G-MgAl9Zn1	3.5912	●	●	●	
Thermoplaste	Thermoplastics	350-700 (150-280 HB)	PVC, Acrylglas PVC, acrylic glass		●	●		
Duroplaste	Duroplastics	20-40	Bakelit, Melamin Graphite	R8510	●	●		
Titan-Legierungen, mittelfest	Titanium alloys, medium strength	-950	TiAl5Sn2,5 TiAl6V4	3.7115 3.7165	○	○		
Titan-Legierungen, hochfest	Titanium alloys, high strength	900-1400	TiAl6Sn2	3.7174	○	○		
Nickelbasis-Legierungen, mittelfest	Nickel based alloys, medium strength	-950	NiCr12Al6MoNb	2.4670				
Nickel-Basis-Legierungen, hochwarmfest	Heat resistant nickel based alloys, high strength	900-1400	NiCr19Fe19NbMo Inconel 718					
Hartguss	Chilled cast iron	300-600	Ni-hard, Ampco					
gehärteter Stahl	hardened steel	45-52 HRC 53-59 HRC						

Auswahlübersicht Selection table

Fräser mit eingelöteten HM-Schneiden Milling Cutters with brazed carbide tips

<ul style="list-style-type: none"> ● sehr gut geeignet well suited ○ auch geeignet also suited 									
Drallwinkel Helix angle						$\lambda = 5^\circ$	$\lambda = 30^\circ$	$\lambda = 0^\circ$	$\lambda = 30^\circ$
Schneidstoffsorten Cutting material						LW615			LW615 LC615T
Seite Page						300	300	302	303
Werkstoff Material	R _m /UTS (N/mm ²)	Beispiel Example	DIN- No.	Kat.-Nr. Cat.-No.					
				1018	1028	1408 1438	1582C 1582 1539		
Unlegierter Baustahl	Plain carbon steel	-700	St 52	1.0052	●	●	●	●	
Automatenstahl	Free cutting steel	-700	9 SMn 28	1.0715	●	●	●	●	
Baustahl	Structural alloy steel	500-950	Ck 45, 26 CrMo 4	1.1191 1.7219	●	●	●	●	
Vergütungsstahl, mittelfest	Heat-treatable steel, medium strength	500-950	42 CrMo 4 50 CrV 4	1.7225 1.2241	●	●	●	●	
Stahlguss	Cast steel	-950	GS 40	1.0416	●	●	●	●	
Einsatzstahl	Case hardening steel	-950	16 MnCr 5	1.7131	●	●	●	●	
Rost- und säurebeständiger Stahl, ferritisch, martensitisch	Stainless steel, ferritic, martensitic	500-950	X 10 Cr 13 X 12 CrMoS17 X 35 CrMo 17	1.4006 1.4104 1.4122		●		●	
Vergütungsstahl, hochfest	Heat-treatable steel, high strength	950-1400	42 CrMo 4 30 CrNiMo 8	1.7225 1.6580	●		○	●	
Nitrierstahl, vergütet	Nitriding steel	950-1400	34 CrAl 6	1.8504	●		○	●	
Werkzeugstahl	Tool steel	950-1400	X 38 CrMoV 5 1 X 155 CrVMo 12 1	1.2343 1.2379	●		○	●	
Rost- und säurebeständiger Stahl, austenitisch	Stainless steel, austenitic	500-950	X 5 CrNi 18 10 X10 CrNiMo 18 10	1.4301 1.4571					
Martensitaushärtbarer Stahl	Maraging steel		X3NiCoMoTi18-9-5	1.2709					
Grauguss	Grey cast iron	-550	GG25	0.6025	●	●		●	
Legierter Grauguss	Alloyed grey cast iron	300-700	GGL-NiCr 35 2	0.6678	●	●		●	
Sphäroguss	Nodular cast iron	-500	GGG60	0.7060	●	●		●	
Temperguss	Malleable cast iron	40-70	GTS55	0.8155	●	●		●	
Rein-Metalle, weich	Pure metals, soft	400-800 (120-310 HB)	Reineisen, Blei pure iron, lead		●	●	●		
Aluminium-Legierungen, langspanend	Aluminium alloys, long chipping	100-400 (120-260 HB)	AlMg 3 AlZnMgCu 1,5	3.3535 3.4365	●	●	●		
Aluminium-Legierungen, kurzspanend	Aluminium alloys, short chipping	-400	G-AlSi 12	3.2581	●	●	●	●	
Kupfer-Legierungen, langspanend	Copper alloys, long chipping	150-250 (160-230 HB)	MS63 CuAl10Ni	2.0320 2.0975	●	●	●		
Kupfer-Legierungen, kurzspanend	Copper alloys, short chipping	-500	MS58	2.0402	●	●	●		
Magnesium-Legierungen	Magnesium alloys	160-300	G-MgAl9Zn1	3.5912	●	●		●	
Thermoplaste	Thermoplastics	350-700 (150-280 HB)	PVC, Acrylglas PVC, acrylic glass		●	●	●		
Duroplaste	Duroplastics	20-40	Bakelit, Melamin		●	●		●	
Graphit	Graphite		Graphite	R8510					
Titan-Legierungen, mittelfest	Titanium alloys, medium strength	-950	TiAl5Sn2,5 TiAl6V4	3.7115 3.7165	○	○		○	
Titan-Legierungen, hochfest	Titanium alloys, high strength	900-1400	TiAl6Sn2	3.7174	○	○		○	
Nickelbasis-Legierungen, mittelfest	Nickel based alloys, medium strength	-950	NiCr12Al6MoNb	2.4670	○	○		○	
Nickel-Basis-Legierungen, hochwarmfest	Heat resistant nickel based alloys, high strength	900-1400	NiCr19Fe19NbMo Inconel 718		○	○		○	
Hartguss	Chilled cast iron	300-600	Ni-hard, Ampco		○	○			
gehärteter Stahl	hardened steel	45-52 HRC 53-59 HRC			○	○		○	

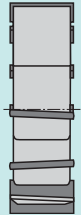

Auswahlübersicht Selection table

Scheibenfräser mit eingelöteten HM-Schneiden Side Milling Cutters with brazed carbide tips

<ul style="list-style-type: none"> ● sehr gut geeignet well suited ○ auch geeignet also suited 						
Typ/Ausführung Type/Design						N
Drallwinkel Helix angle						$\lambda = 6^\circ$
Schneidstoffsorten Cutting material						LW615
Seite Page						301
						Kat.-Nr. Cat.-No.
						1218
Werkstoff	Material	R _m /UTS (N/mm ²)	Beispiel Example	DIN- No.		
Unlegierter Baustahl	Plain carbon steel	-700	St 52	1.0052		●
Automatenstahl	Free cutting steel	-700	9 SMn 28	1.0715		
Baustahl	Structural alloy steel	500-950	Ck 45,	1.1191		●
			26 CrMo 4	1.7219		●
Vergütungsstahl, mittelfest	Heat-treatable steel, medium strength	500-950	42 CrMo 4	1.7225		●
			50 CrV 4	1.2241		●
Stahlguss	Cast steel	-950	GS 40	1.0416		
Einsatzstahl	Case hardening steel	-950	16 MnCr 5	1.7131		●
Rost- und säurebeständiger Stahl, ferritisch, martensitisch	Stainless steel, ferritic, martensitic	500-950	X 10 Cr 13	1.4006		●
			X 12 CrMoS 17	1.4104		
			X 35 CrMo 17	1.4122		
Vergütungsstahl, hochfest	Heat-treatable steel, high strength	950-1400	42 CrMo 4	1.7225		
			30 CrNiMo 8	1.6580		
Nitrierstahl, vergütet	Nitriding steel	950-1400	34 CrAl 6	1.8504		
Werkzeugstahl	Tool steel	950-1400	X 38 CrMoV 5 1	1.2343		
			X 155 CrV Mo 12 1	1.2379		
Rost- und säurebeständiger Stahl, austenitisch	Stainless steel, austenitic	500-950	X 5 CrNi 18 10	1.4301		
			X10 CrNiMo 18 10	1.4571		
Martensitaushärtbarer Stahl	Maraging steel		X3NiCoMoTi18-9-5	1.2709		
Grauguss	Grey cast iron	-550	GG25	0.6025		●
Legierter Grauguss	Alloyed grey cast iron	300-700	GGL-NiCr 35 2	0.6678		●
Sphäroguss	Nodular cast iron	-500	GGG60	0.7060		●
Temperguss	Malleable cast iron	40-70	GTS55	0.8155		●
Rein-Metalle, weich	Pure metals, soft	400-800 (120-310 HB)	Reineisen, Blei pure iron, lead			●
Aluminium-Legierungen, langspanend	Aluminium alloys, long chipping	100-400 (120-260 HB)	AlMg 3	3.3535		●
Aluminium-Legierungen, kurzspanend	Aluminium alloys, short chipping	-400	G-AlSi 12	3.4365		●
Kupfer-Legierungen, langspanend	Copper alloys, long chipping	150-250 (160-230 HB)	MS63	2.0320		●
			CuAl10Ni	2.0975		
Kupfer-Legierungen, kurzspanend	Copper alloys, short chipping	-500	MS58	2.0402		●
Magnesium-Legierungen	Magnesium alloys	160-300	G-MgAl9Zn1	3.5912		●
Thermoplaste	Thermoplastics	350-700 (150-280 HB)	PVC, Acrylglas			●
			PVC, acrylic glass			
Duroplaste	Duroplastics	20-40	Bakelit, Melamin			
Graphit	Graphite		Graphite	R8510		
Titan-Legierungen, mittelfest	Titanium alloys, medium strength	-950	TiAl5Sn2,5	3.7115		○
			TiAl6V4	3.7165		
Titan-Legierungen, hochfest	Titanium alloys, high strength	900-1400	TiAl6Sn2	3.7174		○
Nickelbasis-Legierungen, mittelfest	Nickel based alloys, medium strength	-950	NiCr12Al6MoNb	2.4670		○
Nickel-Basis-Legierungen, hochwarmfest	Heat resistant nickel based alloys, high strength	900-1400	NiCr19Fe19NbMo Inconel 718			○
Hartguss	Chilled cast iron	300-600	Ni-hard, Ampco			○
gehärteter Stahl	hardened steel	45-52 HRC 53-59 HRC				○

Typenbeschreibung Type description



Gewindefräser Thread Milling Cutters

		DIN (WN = Werknorm Fette Standard)	HM-Sorte Carbide Grade	Drallwinkel Helix angle λ	Schaft Shank DIN	Gewindeart Thread	Kat.-Nr. Cat.-No. AL2 Plus	Seite Page
	Gewindefräser für Innengewinde Thread Milling Cutters mit innerer Kühlmittelzufuhr ab Nenn-Ø 6 mm	WN	LC630T	27°	6535HA	ISO-metrisch metric	1721C	297
	Thread Milling Cutters for internal screw thread nominal diameter of 6 mm with internal coolant supply					ISO-metrisch fein metric fine	1723C	
						Withworth Rohr- gewinde pipe thread	1727C	
	Gewindefräser für Innengewinde mit Senker mit innerer Kühlmittelzufuhr ab Nenn-Ø 6 mm	WN	LC630T	27°	6535HA	ISO-metrisch metric	1741C	298
	Thread Milling Cutters for internal screw thread with counterbore nominal diameter of 6 mm with internal coolant supply					ISO-metrisch fein metric fine	1743C	
						Withworth Rohr- gewinde pipe thread	1747C	
	Bohrgewindefräser für Innengewinde mit innerer Kühlmittelzufuhr ab Nenn-Ø 6 mm	WN	LC630T	27°	6535HA	ISO-metrisch metric	1751C	299
	Combined drilling and thread milling cutters nominal diameter of 6 mm with internal coolant supply					ISO-metrisch fein metric fine		

Typenbeschreibung Type description

Fräser mit eingelöteten HM-Schneiden Cutter with brazed carbide tips

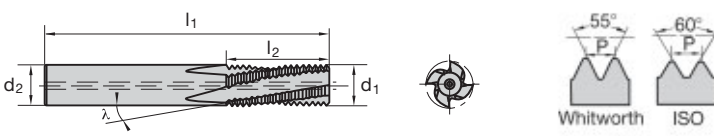
		DIN (WN= Werknorm Fette Standard)	HM-Sorte Carbide Grade	Drallwinkel Helix angle λ	Schaft/ Bohrung Shank/ Bore DIN	Kat.-Nr. Cat.-No. unbe- schichtet uncoated	Kat.-Nr. Cat.-No. AL2 Plus	Seite Page
	Walzenstirnfräser, Typ N mit Längs- und Quernut mit Schneideckenfasen 1 x 45° Shell End Mills, Type N with standard keyway and drive slot with chamfered cutting edges 1 x 45°	≈ 8056	LW615	5°		1018		300
	Walzenstirnfräser, Typ N mit Längs- und Quernut Shell End Mills, Type N with standard keyway and drive slot	1880	LW615	30°		1028		300
	Scheibenfräser kreuzverzahnt, auf drei Seiten schneidend mit Schneideckenfasen 0,5 x 45° Side Milling Cutters staggered tooth, cutting on 3 sides with chamfered cutting edges 0,5 x 45°	8047A	LW615	6°		1218		301
	Langlochfräser Zweischneider Slotting End Mills 2-Flutes	8027A	LW615	0°	1835A	1408		302
		8026			228	1438		
	Schaftfräser 4-6 Schneiden End Mills 4-6 Flutes	≈ 844B	LW615/ LC615T	30°	1835B	1582	1582C	303
		845B/ 845C			228/ 2207	1539		

Vollhartmetall Solid carbide										
Katalog-Nr.	Cat.-No.	1721 C		1723 C		1727 C				
Drallwinkel	Helix angle			$\lambda = 27^\circ$						
Zylinderschaft	Straight shank			 DIN 6535 HA ²⁾						
Beschichtung	Coating			AL2 Plus						
Besonderheiten	Special features			Ausführung ohne Hals; Ab Nennmaß M6 mit innerer Kühlmittelzufuhr						
				Without neck; Nominal size of M6 with internal coolant supply						
Schneidstoffsorten ¹⁾	Cutting materials ¹⁾			LC630T						
Nennmaß Nominal Size	P Gg/1"	d ₁	l ₁	l ₂ 1,5 x D	l ₂ 2 x D	d ₂ h 6	z	Ident No.	Ident No.	Ident No.
Metrisches ISO-Gewinde Metric ISO thread										
M 3	0,5	2,3	48	5,2	-	6	3	1300703	-	-
M 4	0,7	3	48	7,3	-	6	3	1300705	-	-
M 5	0,8	3,8	48	9,2	-	6	3	1300707	-	-
M 6	1	4,5	54	-	13,5	6	3	1300709	-	-
M 8	1,25	5,95	54	-	18,1	6	3	1300712	-	-
M 10	1,5	7,95	64	-	21,7	8	4	1300714	-	-
M 12	1,75	9,95	72	-	25,4	10	4	1300716	-	-
M 14	2	11,6	74	-	31	10	4	1300718	-	-
M 16	13,6	80	74	-	35	12	4	1300850	-	-
M 18(20)	2,5	13,95	90	-	41,2	14	4	1300723	-	-
Metrisches ISO-Feingewinde Metric ISO fine thread										
M 6	0,5	4,5	54	-	12,7	6	3	-	1300727	-
M 6	0,75	4,5	54	-	13,1	6	3	-	1300725	-
M 8	1	5,95	54	-	17,5	6	3	-	1300729	-
M 10	1	7,95	64	-	21,5	8	4	-	1300731	-
M 10	1,5	7,75	64	-	21,9	8	4	-	1300735	-
M 12	1,0	9,95	72	-	25,5	10	4	-	1300733	-
M 12	1,5	9,95	72	-	26,2	10	4	-	1300737	-
Whitworth Rohrgewinde Whitworth pipe thread										
G 1/4	19	9,95	72	-	22	10	4	-	-	1300742
G 3/8	19	13,6	80	-	27,5	4	4	-	-	1300744
G 1/8	28	7,95	64	-	16	8	4	-	-	1300740

¹⁾ Sortenbeschreibung siehe Seite 22
¹⁾ Description of grades see page 22

²⁾ Zylinderschaft nach DIN 6535 HB und HE auf Anfrage
²⁾ Straight shank to DIN 6535 HB and HE on request

Schnittwertempfehlungen ab Seite 306
Cutting data recommendations starting page 306

Vollhartmetall
Solid carbide

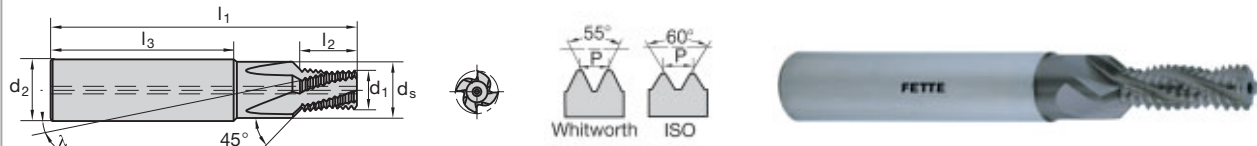

Katalog-Nr.	Cat.-No.	1741 C	1743 C	1747 C
Drallwinkel	Helix angle		$\lambda = 27^\circ$	
Zylinderschaft	Straight shank		DIN 6535 HA ²⁾	
Beschichtung	Coating		AL2 Plus	
Besonderheiten	Special features	mit Senker; Ab Nennmaß M6 mit innerer Kühlmittelzufuhr with counterbore; Nominal size of M6 with internal coolant supply		
Schneidstoffsorten ¹⁾	Cutting materials ¹⁾	LC630T		

Nennmaß Nominal Size	P Gg/1"	d ₁	l ₁	l ₂ 1,5 x D	d ₂	l ₃	d _s	z	Ident No.	Ident No.	Ident No.
Metrisches ISO-Gewinde Metric ISO thread											
M 3	0,5	2,3	48	5,2	6	36	3,4	3	1300746	-	-
M 4	0,7	3	48	7,3	6	36	4,5	3	1300749	-	-
M 5	0,8	3,8	54	9,2	6	36	5,5	3	1300751	-	-
M 6	1	4,5	62	10,5	8	36	6,6	3	1300753	-	-
M 8	1,2	5,95	74	13,7	10	40	9	3	1300755	-	-
M 10	1,5	7,95	80	17,2	12	45	11	4	1300758	-	-
M 12	1,7	9,95	90	20,1	14	45	13,5	4	1300760	-	-
M 14	2	11,6	102	25	16	48	15,5	4	1300762	-	-
M 16	2	13,6	102	27	18	48	17,5	4	1300764	-	-
Metrisches ISO-Feingewinde Metric ISO fine thread											
M 6	0,5	4,5	62	9,7	8	36	6,6	3	-	1300769	-
M 6	0,75	4,5	62	10,1	8	36	6,6	3	-	1300767	-
M 8	1	5,95	74	13,5	10	40	9	3	-	1300771	-
M 10	1	7,95	80	16,5	12	45	11	4	-	1300773	-
M 12	1	9,95	90	19,5	14	45	13,5	4	-	1300778	-
M 10	1,25	7,95	80	16,9	12	45	11	4	-	1300776	-
M 12	1,5	9,95	90	20,2	14	45	13,5	4	-	1300780	-
M 14	1,5	11,6	102	23,2	16	48	15,5	4	-	1300782	-
M 16	1,5	13,6	102	26,2	18	48	17,5	4	-	1300785	-
Whitworth Rohrgewinde Whitworth pipe thread											
G 1/4	19	9,95	90	22,1	14	45	13,9	4	-	-	1300789
G 3/8	19	13,6	102	27,4	18	48	17,5	4	-	-	1300791
G 1/8	28	7,95	80	15,9	12	45	11	4	-	-	1300787

¹⁾ Sortenbeschreibung siehe Seite 22
¹⁾ Description of grades see page 22

²⁾ Zylinderschaft nach DIN 6535 HB und HE auf Anfrage
²⁾ Straight shank to DIN 6535 HB and HE on request

Schnittwertempfehlungen ab Seite 306
Cutting data recommendations starting page 306

Vollhartmetall Solid carbide												
Katalog-Nr.	Cat.-No.											1751 C
Drallwinkel	Helix angle											$\lambda = 27^\circ$
Zylinderschaft	Straight shank											DIN 6535 HA
Beschichtung	Coating											AL2 Plus
Besonderheiten	Special features											Nicht für Stahlbearbeitung geeignet Ab Nennmaß M6 mit innerer Kühlmittelzufuhr Not useable steel application Nominal size of M6 with internal coolant supply
Schneidstoffsorten ¹⁾	Cutting materials ¹⁾											LC630T
Nennmaß Nominal Size	P Gg/1"	l_1	l_2 1,5xD	l_2 2xD	d_2	l_3	d_s	l_6	d_k	z	Ident No.	
Metrisches ISO-Gewinde Metric ISO thread												
M 3	0,5	48	5,4	–	6	36	3,4	0,5	2,5	2		1300796
M 3	0,5	48	–	6,9	6	36	3,4	0,5	2,5	2		1300794
M 4	0,7	48	6,9	–	6	36	4,5	0,7	3,3	2		1300801
M 4	0,7	48	–	9	6	36	4,5	0,7	3,3	2		1300789
M 5	0,8	54	8,7	–	6	36	5,5	0,8	4,2	2		1300805
M 5	0,8	54	–	11,1	6	36	5,5	0,8	4,2	2		1300803
M 6	1	62	10,9	–	8	36	6,6	1	5	2		1300809
M 6	1	62	–	13,9	8	36	6,6	1	5	2		1300807
M 8	1,25	74	13,7	–	10	40	9	1,25	6,8	2		1300813
M 8	1,25	74	–	18,7	10	40	9	1,25	6,8	2		1300811
M 10	1,5	80	18	–	12	45	11	1,5	8,5	2		1300822
M 10	1,5	80	–	22,5	12	45	11	1,5	8,5	2		1300820
M 12	1,75	90	20,8	–	14	45	13,5	1,5	10,2	2		1300831
M 12	1,75	90	–	26,1	14	45	13,5	1,5	10,2	2		1300829
M 16	2	102	26	–	18	48	17,5	1,5	14	2		1300844
M 16	2	102	–	36	18	48	17,5	1,5	14	2		1300842
Metrisches ISO-Feingewinde Metric ISO fine thread												
M 8	1	74	13,8	–	10	40	9	1	7	2		1300817
M 8	1	74	–	17,8	10	40	9	1	7	2		1300815
M 10	1	80	16,1	–	12	45	11	1	9	2		1300826
M 10	1	80	–	21,1	12	45	11	1	9	2		1300824
M 12	1	90	19,5	–	14	45	13,5	1	11	2		1300835
M 12	1	90	–	25,5	14	45	13,5	1	11	2		1300833
M 12	1,5	90	20,6	–	14	45	13,5	1,5	10,5	2		1300840
M 12	1,5	90	–	26,6	14	45	13,5	1,5	10,5	2		1300838
M 16	1,5	102	25,9	–	18	45	17,5	1,5	14,5	2		1300849
M 16	1,5	102	–	33,4	18	48	17,5	1,5	12,5	2		1300847

¹⁾ Sortenbeschreibung siehe Seite 22
¹⁾ Description of grades see page 22

Schnittwertempfehlungen ab Seite 306
Cutting data recommendations starting page 306

mit HM-Schneiden
NC-gerecht

Carbide-tipped
suitable for NC

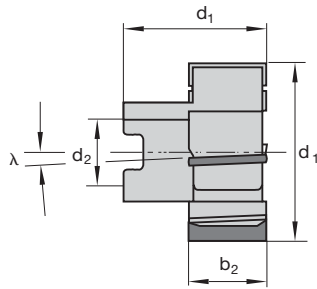

Katalog-Nr.	Cat.-No.	1018		1028		
Typ	Type	N				
Norm	Standard	≈ DIN 8056 ²⁾		DIN 1880		
Axial- / Drallwinkel	Axial- / Helix angle	λ = 5°		λ = 30°		
Besonderheiten	Special features	mit Längs- und Quernut with standard keyway and drive slot				
Beschichtung	Coating	-				
Schneidstoffsorten ³⁾	Cutting materials ³⁾	LW615				
d ₁	b ₁	b ₂	d ₂	z	Ident No.	Ident No.
40	32	16	16	6	1014219	-
40	32	32	16	6	-	1014406 ¹⁾
50	36	16	22	6	1014228	-
50	36	36	22	6	-	1014415
63	40	22	27	8	1014237	-
63	40	40	27	8	-	1014424
80	45	22	27	8	1014246	-
100	50	22	32	10	1014255	-

¹⁾ nur mit Quernut
¹⁾ only with drive slot

²⁾ Die Schneidecken sind angefast
²⁾ The cutting edges are chamfered

³⁾ Sortenbeschreibung siehe Seite 22
³⁾ Description of grades see page 22

Schnittwertempfehlungen ab Seite 304
Cutting data recommendations starting page 304

mit HM-Schneiden
auf 3 Seiten schneidend
NC-gerecht

Carbide-tipped
cutting on 3 sides
suitable for NC

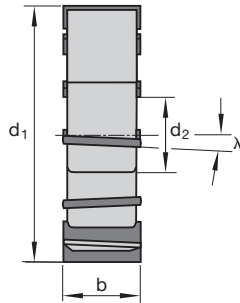

Katalog-Nr.	Cat.-No.	1218
Typ	Type	N
Norm	Standard	DIN 8047 A
Axialwinkel	Axial angle	$\lambda = 6^\circ$
Besonderheiten	Special features	kreuzverzahnt staggered tooth
Schneidstoffsorten ¹⁾	Cutting materials ¹⁾	LW615

d ₁ k 14	d ₂ h 7	b ₁ k 11	z	Ident No.
63	27	6	8	1086613
63	27	8	8	1086622
63	27	10	8	1086631
63	27	12	8	1086640
63	27	16	8	1086668
63	27	20	8	1086686
80	32	6	8	1086702
80	32	8	8	1086711
80	32	10	8	1086720
80	32	12	8	1086739
80	32	16	8	1086757
80	32	20	8	1086775
100	40	6	10	1086793
100	40	8	10	1086800
100	40	10	10	1086819
100	40	12	10	1086828
100	40	16	10	1086846
100	40	18	10	1086855
100	40	20	10	1086864

¹⁾ Sortenbeschreibung siehe Seite 22
¹⁾ Description of grades see page 22

Schnittwertempfehlungen ab Seite 304
Cutting data recommendations starting page 304

mit HM-Schneiden
stirnseitig bis Mitte schneidend
NC-gerecht

Carbide-tipped
center cutting
suitable for NC

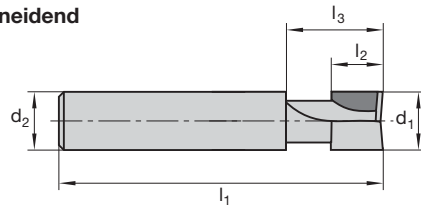

Katalog-Nr.	Cat.-No.	1408	1438
Typ	Type	N	
Norm	Standard	DIN 8027 A	DIN 8026
Drallwinkel	Helix angle	$\lambda = 0^\circ$	
Schaft	Shank	DIN 6535 HA	DIN 228
Beschichtung	Coating	-	
Schneidstoffsorten ¹⁾	Cutting materials ¹⁾	LW615	

d ₁ e 8	l ₂	l ₁	l ₃	d ₂ h 6	Ident No.	Ident No.
8	12	57	17	10	1111818	-
10	12	60	20	10	1111827	-
12	16	70	25	12	1111836	-
14	19	70	25	12	1111845	-
15	22	80	32	16	1111854	-
16	22	80	32	16	1111863	-
18	22	80	32	16	1111872	-
20	22	80	32	16	1111881	-
22	25	90	40	20	1111890	-
24	25	101	45	25	1111907	-
25	25	101	45	25	1111916	-
26	25	101	45	25	1111925	-
28	25	101	45	25	1111934	-
30	30	105	49	25	1111943	-
32	30	110	50	32	1111952	-
MK						
18	22	101	37	2	-	1117153
20	22	122	41	3	-	1117162
22	25	126	45	3	-	1117171
24	25	131	50	3	-	1117180
25	25	131	50	3	-	1117199
26	25	131	50	3	-	1117206
28	25	131	50	3	-	1117215
30	30	136	55	3	-	1117224
32	30	136	55	3	-	1117233
34	30	162	59,5	3	-	1117242
36	30	162	59,5	4	-	1117251
40	30	165	62,5	4	-	1117279

¹⁾ Sortenbeschreibung siehe Seite 22

¹⁾ Description of grades see page 22

Schnittwertempfehlungen ab Seite 304

Cutting data recommendations starting page 304

mit HM-Schneiden
NC-gerecht

Carbide-tipped
suitable for NC

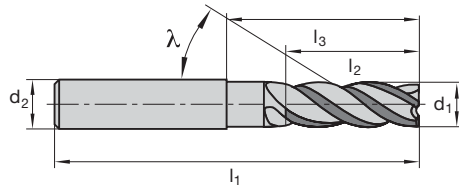

Katalog-Nr.	Cat.-No.	1582	1582 C	1539
Typ	Type	N		
Norm	Standard	≈ DIN 844 B		≈ DIN 845
Drallwinkel	Helix angle	λ = 30°		
Schaft	Shank	DIN 6535 HB		DIN 228 / 2207
Beschichtung	Coating	-	AL2 Plus	-
Schneidstoffsorten ¹⁾	Cutting materials ¹⁾	LW615	LC615T	LW615

d ₁ k 10	l ₂	l ₁	l ₃	d ₂ h 6	z	Ident No.	Ident No.	Ident No.
20	38	103	54	20	4	1140804	1112552	-
25	45	120	65	25	4	1140813	1112554	-
30	45	121	65	25	5	1140822	1112556	-
32	53	133	73	32	5	1140825	1112558	-
40	63	155	85	40	6	1140827	1112560	-

MK

20	38	122	59	2	4	-	-	1154638
25	45	146	66	3	4	-	-	1154647
32	53	200	103,5	4	5	-	-	1154656
40	63	210	113,5	4	6	-	-	1154665

¹⁾ Sortenbeschreibung siehe Seite 22
¹⁾ Description of grades see page 22

Schnittwertempfehlungen ab Seite 304
Cutting data recommendations starting page 304

Werkstoff	Material	R _m /UTS (N/mm ²)	Beispiel Exampel	DIN- Nr.	HM- Sorte Carbide Grade	Schnitt- geschwin- digkeit Cutting speed v _c [m/min]	Vorschub pro Zahn Feed per tooth f _z [mm/z.]			
							Ø ≤ 10	Ø 12	Ø 16	Ø ≥ 20
Unlegierter Baustahl	Plain carbon steel	-700	St 52	1.0052	LC615T	160	0,05	0,08	0,12	0,14
Automatenstahl	Free cutting steel	-700	9 SMn 28	1.0715	LC615T	160	0,05	0,08	0,12	0,14
Baustahl	Structural alloy steel	500-950	Ck 45, 26 CrMo 4	1.1191 1.7219	LC615T	140	0,04	0,06	0,08	0,1
Vergütungsstahl, mittelfest	Heat-treatable steel, medium strength	500-950	42 CrMo 4 50 CrV 4	1.7225 1.2241	LC615T	100	0,04	0,06	0,08	0,1
Stahlguss	Cast steel	-950	GS 40	1.0416	LC615T	80	0,04	0,06	0,08	0,1
Einsatzstahl	Case hardening steel	-950	16 MnCr 5	1.7131	LC615T	100	0,04	0,06	0,08	0,1
Rost- und säurebeständiger Stahl, ferritisch, martensitisch	Stainless steel, ferritic, martensitic	500-950	X 10 Cr 13 X 12 CrMoS 17 X 35 CrMo 17	1.4006 1.4104 1.4122	LC615T	50	0,02	0,04	0,05	0,06
Vergütungsstahl, hochfest	Heat-treatable steel, high strength	950-1400	42 CrMo 4 30 CrNiMo 8	1.7225 1.6580	LC615T	80	0,02	0,04	0,06	0,08
Nitrierstahl, vergütet	Nitriding steel	950-1400	34 CrAl 6	1.8504	LC615T	80	0,02	0,04	0,06	0,08
Werkzeugstahl	Tool steel	950-1400	X 38 CrMoV 5 1 X 155 CrV Mo 12 1	1.2343 1.2379	LC615T	80	0,02	0,04	0,06	0,08
Rost- und säurebeständiger Stahl, austenitisch	Stainless steel, austenitic	500-950	X 5 CrNi 18 10 X10 CrNiMo 18 10	1.4301 1.4571	LW615	50	0,02	0,05	0,08	0,1
Martensitaushärtbarer Stahl	Maraging steel		X3NiCoMoTi18-9-5	1.2709	LW615					
Grauguss	Grey cast iron	-550	GG25	0.6025	LW615	140	0,05	0,08	0,12	0,14
Legierter Grauguss	Alloyed grey cast iron	300-700	GGL-NiCr 35 2	0.6678	LW615	110	0,04	0,06	0,08	0,1
Sphäroguss	Nodular cast iron	-500	GGG60	0.7060	LW615	110	0,04	0,07	0,1	0,12
Temperguss	Malleable cast iron	40-70	GTS55	0.8155	LW615	100	0,05	0,08	0,12	0,14
Rein-Metalle, weich	Pure metals, soft	400-800 (120-310 HB)	Reineisen, Blei pure iron, lead		LC615T	250	0,04	0,08	0,12	0,14
Aluminium-Legierungen, langspanend	Aluminium alloys, long chipping	100-400 (120-260 HB)	AlMg 3 AlZnMgCu 1,5	3.3535 3.4365	LW615 ¹⁾	900	0,05	0,08	0,12	0,14
Aluminium-Legierungen, kurzspanend	Aluminium alloys, short chipping	-400	G-AlSi 12	3.2581	LW615 ¹⁾	250	0,05	0,08	0,12	0,14
Kupfer-Legierungen, langspanend	Copper alloys, long chipping	150-250 (160-230 HB)	MS63 CuAl10Ni	2.0320 2.0975	LC615T	300	0,04	0,08	0,12	0,14
Kupfer-Legierungen, kurzspanend	Copper alloys, short chipping	-500	MS58	2.0402	LC615T	210	0,04	0,08	0,12	0,14
Magnesium-Legierungen	Magnesium alloys	160-300	G-MgAl9Zn1	3.5912	LW615	400	0,05	0,08	0,12	0,14
Thermoplaste	Thermoplastics	350-700 (150-280 HB)	PVC, Acrylglas PVC, acrylic glass		LW615 ¹⁾	250	0,05	0,09	0,15	0,2
Duroplaste	Duroplastics	20-40	Bakelit, Melamin		LW615 ¹⁾	300	0,05	0,09	0,15	0,2
Graphit	Graphite		Graphite	R8510						
Titan-Legierungen, mittelfest	Titanium alloys, medium strength	-950	TiAl5Sn2,5 TiAl6V4	3.7115 3.7165	LW615 ¹⁾	60	0,03	0,05	0,07	0,08
Titan-Legierungen, hochfest	Titanium alloys, hight strength	900-1400	TiAl6Sn2	3.7174	LW615 ¹⁾	40	0,02	0,04	0,05	0,06
Nickelbasis-Legierungen, mittelfest	Nickel based alloys, medium strength	-950	NiCr12Al6MoNb	2.4670	LC615T	30	0,03	0,04	0,05	0,06
Nickel-Basis-Legierungen, hochwarmfest	Heat resistant nickel based alloys, high strength	900-1400	NiCr19Fe19NbMo Inconel 718		LC615T	20	0,02	0,03	0,04	0,05
Hartguss	Chilled cast iron	300-600	Ni-hard, Ampco		LC615T	40	0,02	0,04	0,05	0,06
gehärteter Stahl	hardened steel	45-52 HRC 53-59 HRC			-	-	-	-	-	-

¹⁾ Unbeschichtete HM-Sorte, v_c-Wert der Tabelle ist gültig

¹⁾ Uncoated grade, value of v_c is valid

Beim Einsatz unbeschichteter Sorten Schnittgeschwindigkeit um 30 % reduzieren.

When using uncoated grades reduce cutting speed by 30 %.

Formeln Formulas

Drehzahl Speed n (min⁻¹):

$$n = \frac{v_c \cdot 1000}{\pi \cdot d_1} \quad v_c \text{ Tab. Seite 304 Page 304}$$

Vorschubgeschwindigkeit Feed rate v_f (mm/min):

$$v_f = f_z \cdot z \cdot n \cdot f_2 \quad f_z \text{ Tab. Seite 304 Page 304}$$

Spanvolumen Chip volume Q (cm³/min):

$$Q = \frac{a_e \cdot a_p \cdot v_f}{1000}$$

a_e = Schnittbreite Width of cut (mm)
 a_p = Schnitttiefe Depth of cut (mm)
 d₁ = Durchmesser (mm) diameter (mm)
 b₁ = Schneidenlängen Cutting length
 f₂ = Korrekturfaktor für v_f Correction factor
 f_z = Vorschub pro Zahn Feed per tooth (mm)
 n = Drehzahl (min⁻¹) Speed (min⁻¹)
 Q = Spanvolumen Chip volume (cm³/min)
 v_c = Schnittgeschwindigkeit Cutting speed (m/min)
 v_f = Vorschubgeschwindigkeit Feed rate (mm/min)
 z = Anzahl der Schneiden No. of teeth

Vorschub-Korrektur-Faktoren f₂ für HM-Schafffräser (gelötet) Feed Correction Factor f₂ for Carbide End Mills (brazed)

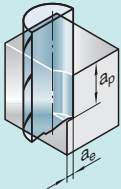
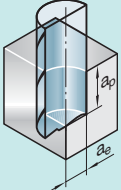
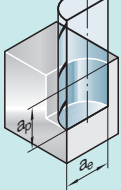
	$v_f = f_z \cdot z \cdot n \cdot f_2$ a _e =	$v_f = f_z \cdot z \cdot n \cdot f_2$ a _p =	$v_f = f_z \cdot z \cdot n \cdot f_2$ f _z =
	0,1 · d ₁	1,5 · d ₁	1
	0,5 · d ₁ ¹⁾	1 · d ₁	0,6
	1 · d ₁ ¹⁾	0,5 · d ₁	0,4

¹⁾ Nicht für Kat.-Nr. 1582, 1582 C, 1539 ¹⁾ Not for Cat.-No. 1582, 1582 C, 1539

Vorschub-Korrektur f₂ für Walzenstirnfräser (gelötet) Feed rate correction factor f₂ for Shell End Mills (brazed)

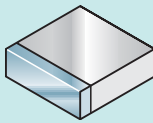
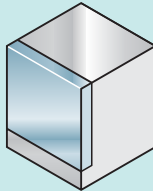
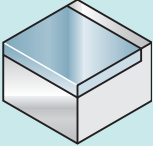
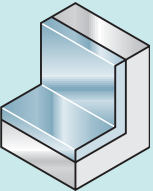
			
a _e < 0,1 · d ₁	a _e < 0,1 · d ₁	a _e < 0,75 · d ₁ a _p < 0,1 · b ₁	a _e < 0,2 · d ₁ a _p < 0,1 · b ₁
f ₂ = 1	f ₂ = 1	f ₂ = 0,6	f ₂ = 0,5

Werkstoff	Material	R _m /UTS (N/mm ²)	Beispiel Example	DIN-Nr.	Schnittgeschwindigkeit Cutting speed v _c [m/min]	Vorschub Fräsen Feed Milling f _z [mm/z.]	Vorschub Bohren Feed Drilling f/U [mm/U]
Unlegierter Baustahl	Plain carbon steel	-700	St 52	1.0052	80-150	0,02-0,15	-
Automatenstahl	Free cutting steel	-700	9 SMn 28	1.0715	80-150	0,02-0,15	-
Baustahl	Structural alloy steel	500-950	Ck 45, 26 CrMo 4	1.1191 1.7219	60-120	0,02-01	-
Vergütungsstahl, mittelfest	Heat-treatable steel, medium strength	500-950	42 CrMo 4 50 CrV 4	1.7225 1.2241	60-120	0,02-0,1	-
Stahlguss	Cast steel	-950	GS 40	1.0416	60-120	0,02-0,1	-
Einsatzstahl	Case hardening steel	-950	16 MnCr 5	1.7131	60-120	0,02-0,1	-
Rost- und säurebeständiger Stahl, ferritisch, martensitisch	Stainless steel, ferritic, martensitic	500-950	X 10 Cr 13 X 12 CrMoS 17 X 35 CrMo 17	1.4006 1.4104 1.4122	50-60	0,04-0,07	-
Vergütungsstahl, hochfest	Heat-treatable steel, high strength	950-1400	42 CrMo 4 30 CrNiMo 8	1.7225 1.6580	60-100	0,01-0,08	-
Nitrierstahl, vergütet	Nitriding steel	950-1400	34 CrAl 6	1.8504	60-100	0,01-0,08	-
Werkzeugstahl	Tool steel	950-1400	X 38 CrMoV 5 1 X 155 CrVMo 12 1	1.2343 1.2379	60-100	0,01-0,08	-
Rost- und säurebeständiger Stahl, austenitisch	Stainless steel, austenitic	500-950	X 5 CrNi 18 10 X10 CrNiMo 18 10	1.4301 1.4571	60-80	0,04-0,08	-
Martensitahärtbarer Stahl	Maraging steel		X3NiCoMoTi18-9-5	1.2709			
Grauguss	Grey cast iron	-550	GG25	0.6025	100-160	0,05-0,15	0,05-0,25
Legierter Grauguss	Alloyed grey cast iron	300-700	GGL-NiCr 35 2	0.6678	100-140	0,03-0,1	0,05-0,25
Sphäroguss	Nodular cast iron	-500	GGG60	0.7060	80-120	0,03-0,1	0,05-0,2
Temperguss	Malleable cast iron	40-70	GTS55	0.8155	100-140	0,05-0,15	0,05-0,25
Rein-Metalle, weich	Pure metals, soft	400-800 (120-310 HB)	Reineisen, Blei pure iron, lead		300-400	0,05-0,25	0,05-0,4
Aluminium-Legierungen, langspanend	Aluminium alloys, long chipping	100-400 (120-260 HB)	AlMg 3 AlZnMgCu 1,5	3.3535 3.4365	300-400	0,05-0,25	0,05-0,4
Aluminium-Legierungen, kurzspanend	Aluminium alloys, short chipping	-400	G-AlSi 12	3.2581	300-400	0,05-0,25	0,05-0,4
Kupfer-Legierungen, langspanend	Copper alloys, long chipping	150-250 (160-230 HB)	MS63 CuAl10Ni	2.0320 2.0975	300-400	0,05-0,25	0,05-0,4
Kupfer-Legierungen, kurzspanend	Copper alloys, short chipping	-500	MS58	2.0402	300-400	0,1 -0,25	-
Magnesium-Legierungen	Magnesium alloys	160-300	G-MgAl9Zn1	3.5912	250-300	0,05-0,15	-
Thermoplaste	Thermoplastics	350-700 (150-280 HB)	PVC, Acrylglas PVC, acrylic glass		300-400	0,05-0,25	0,05-0,4
Duroplaste	Duroplastics	20-40	Bakelit, Melamin		300-400	0,05-0,25	-
Graphit	Graphite		Graphite	R8510	300-400	0,05-0,25	-
Titan-Legierungen, mittelfest	Titanium alloys, medium strength	-950	TiAl5Sn2,5 TiAl6V4	3.7115 3.7165	60-70	0,03-0,08	-
Titan-Legierungen, hochfest	Titanium alloys, high strength	900-1400	TiAl6Sn2	3.7174	50-60	0,01-0,05	-
Nickelbasis-Legierungen, mittelfest	Nickel based alloys, medium strength	-950	NiCr12Al6MoNb	2.4670	-	-	-
Nickel-Basis-Legierungen, hochwarmfest	Heat resistant nickel based alloys, high strength	900-1400	NiCr19Fe19NbMo Inconel 718		-	-	-
Hartguss	Chilled cast iron	300-600	Ni-hard, Ampco		-	-	-
gehärteter Stahl	hardened steel	45-52 HRC 53-59 HRC			-	-	-

¹⁾ Die Vorschübe gelten für Gewinde-Nenn-Ø ≥ 5 mm. Für Gewinde-Nenn-Ø < 5 mm müssen die Vorschübe entsprechend reduziert werden.

¹⁾ The recommendations apply to threads with a nominal diameter ≥ 5 mm. They must be reduced accordingly for threads with a nominal diameter < 5 mm.

²⁾ Bei langspanenden Werkstoffen kann ein- oder mehrfaches Entspanen notwendig sein!

²⁾ when working with materials producing long chippings it may be necessary to remove these from time to time.

Schnittgeschwindigkeit Bohren. Wir empfehlen die Werte um 30 % zu reduzieren. Bei langspanenden Werkstoffen die geringeren Werte anwenden.

Drilling speeds. We recommend to reduce the speeds about 30 %. Use lower speeds when working on long chipping materials.



HSC-line und Fräser für den Gesenk- und Formenbau

HSC-line and Milling Cutters for mould and die industry

Auswahlübersicht Selection table	310, 312
Typenbeschreibung Type description	314
HSCline-Schaftfräser HSCline-End Mills gerade und runde Stirn, kurz, lang, extra lang square end and ball nose, short, long, extra long	316
HSCline-Schaftfräser, Mini HSCline-End Mills, Mini kurz, lang, extra lang short, long, extra long	318
HSCline-Schaftfräser HSCline-End Mills torisch und mit Vollradius toric and with full radius	319
Kugelpkopierschaftfräser Ball Nose Copying End Mills extra lang extra long	320
Schaftfräser zur Graphitbearbeitung End Mills for Graphite Machining gerade oder runde Stirn – diamantbeschichtet square end or ball nose – diamond coated	321
Kugelschaftfräser Ball Nose End Mills Zweischneider, lang 2 Flutes, long	322
Vierschneider, lang 4 Flutes, long	323
HSCline-Schaftfräser HSCline-End Mills lang long	324
Schnittwertempfehlungen Cutting data recommendations	326

Auswahlübersicht Selection table

HSCline und Fräser für Gesenk- und Formenbau HSCline and Milling Cutters for mould and die industry

<ul style="list-style-type: none"> ● sehr gut geeignet well suited ○ auch geeignet also suited 					
Typ Type					
K = kurz short L = lang long EL = extra lang extra long Ausführung Design					
Zähnezahl No. of teeth					
Drallwinkel Helix angle					
Spanwinkel Rake angle					
Schneidstoffsorten Cutting material					
Werkstoff	Material	R _m /UTS (N/mm ²)	Beispiel Example	DIN-No.	
Unlegierter Baustahl	Plain carbon steel	-700	St 52	1.0052	
Automatenstahl	Free cutting steel	-700	9 SMn 28	1.0715	
Baustahl	Structural alloy steel	500-950	Ck 45	1.1191	
			26 CrMo 4	1.7219	
Vergütungsstahl, mittelfest	Heat-treatable steel, medium strength	500-950	42 CrMo 4	1.7225	
			50 CrV 4	1.2241	
Stahlguss	Cast steel	-950	GS 40	1.0416	
Einsatzstahl	Case hardening steel	-950	16 MnCr 5	1.7131	
Rost- und säurebeständiger Stahl, ferritisch, martensitisch	Stainless steel, ferritic, martensitic	500-950	X 10 Cr 13	1.4006	
			X 12 CrMoS 17	1.4104	
			X 35 CrMo 17	1.4122	
Vergütungsstahl, hochfest	Heat-treatable steel, high strength	950-1400	42 CrMo 4	1.7225	
			30 CrNiMo 8	1.6580	
Nitrierstahl, vergütet	Nitriding steel	950-1400	34 CrAl 6	1.8504	
Werkzeugstahl	Tool steel	950-1400	X 38 CrMoV 5 1	1.2343	
			X 155 CrVMo 12 1	1.2379	
Rost- und säurebeständiger Stahl, austenitisch	Stainless steel, austenitic	500-950	X 5 CrNi 18 10	1.4301	
			X10 CrNiMo 18 10	1.4571	
Martensitaushärtbarer Stahl	Maraging steel			1.2709	
Grauguss	Grey cast iron	-550	GG25	0.6025	
Legierter Grauguss	Alloyed grey cast iron	300-700	GGL-NiCr 35 2	0.6678	
Sphäroguss	Nodular cast iron	-500	GGG60	0.7060	
Temperguss	Malleable cast iron	40-70	GTS55	0.8155	
Rein-Metalle, weich	Pure metals, soft	400-800 (120-310 HB)	Reineisen, Blei pure iron, lead	1.1003	
Aluminium-Legierungen, langspanend	Aluminium alloys, long chipping	100-400 (120-260 HB)	AlMg 3	3.3535	
			AlZnMgCu 1,5	3.4365	
Aluminium-Legierungen, kurzspanend	Aluminium alloys, short chipping	-400	G-AlSi 12	3.2581	
Kupfer-Legierungen, langspanend	Copper alloys, long chipping	150-250 (160-230 Hb)	MS63	2.0320	
			CuAl10Ni	2.0975	
Kupfer-Legierungen, kurzspanend	Copper alloys, short chipping	-500	MS58	2.0402	
Magnesium-Legierungen	Magnesium alloys	160-300	G-MgAl9Zn1	3.5912	
Thermoplaste	Thermoplastics	350-700 (150-280 HB)	PVC, Acrylglas PVC, acrylic glass		
Duroplaste	Duroplastics	20-40	Bakelit, Melamin		
Graphit	Graphite		Graphite	R8510	
Titan-Legierungen, mittelfest	Titanium alloys, medium strength	-950	TiAl5Sn2,5	3.7115	
			TiAl6V4	3.7165	
Titan-Legierungen, hochfest	Titanium alloys, high strength	900-140	TiAl6Sn2	3.7174	
Nickelbasis-Legierungen, mittelfest	Nickel based alloys, medium strength	-950	NiCr12Al6MoNb	2.4670	
Nickel-Basis-Legierungen, hochwarmfest	Heat resistant nickel based alloys, high strength	900-1400	NiCr19Fe19NbMo Inconel 718		
Hartguss	Chilled cast iron	300-600	Ni-hard, Ampco		
Gehärteter Stahl	Hardened steel	45-52 HRC 53-59 HRC			

Auswahlübersicht Selection table

HSCline und Fräser für Gesenk- und Formenbau HSCline and Milling Cutters for mould and die industry

<ul style="list-style-type: none"> ● sehr gut geeignet well suited ○ auch geeignet also suited 					
Typ Type					
K = kurz short L = lang long EL = extra lang extra long Ausführung Design					
Zähnezahl No. of teeth					
Drallwinkel Helix angle					
Spanwinkel Rake angle					
Schneidstoffsorten Cutting material					
Werkstoff	Material	R _m /UTS (N/mm ²)	Beispiel Example	DIN-No.	
Unlegierter Baustahl	Plain carbon steel	-700	St 52	1.0052	
Automatenstahl	Free cutting steel	-700	9 SMn 28	1.0715	
Baustahl	Structural alloy steel	500-950	Ck 45	1.1191	
			26 CrMo 4	1.7219	
Vergütungsstahl, mittelfest	Heat-treatable steel, medium strength	500-950	42 CrMo 4	1.7225	
			50 CrV 4	1.2241	
Stahlguss	Cast steel	-950	GS 40	1.0416	
Einsatzstahl	Case hardening steel	-950	16 MnCr 5	1.7131	
Rost- und säurebeständiger Stahl, ferritisch, martensitisch	Stainless steel, ferritic, martensitic	500-950	X 10 Cr 13	1.4006	
			X 12 CrMoS 17	1.4104	
			X 35 CrMo 17	1.4122	
Vergütungsstahl, hochfest	Heat-treatable steel, high strength	950-1400	42 CrMo 4	1.7225	
			30 CrNiMo 8	1.6580	
Nitrierstahl, vergütet	Nitriding steel	950-1400	34 CrAl 6	1.8504	
Werkzeugstahl	Tool steel	950-1400	X 38 CrMoV 5 1	1.2343	
			X 155 CrVMo 12 1	1.2379	
Rost- und säurebeständiger Stahl, austenitisch	Stainless steel, austenitic	500-950	X 5 CrNi 18 10	1.4301	
			X10 CrNiMo 18 10	1.4571	
Martensitaushärtbarer Stahl	Maraging steel			1.2709	
Grauguss	Grey cast iron	-550	GG25	0.6025	
Legierter Grauguss	Alloyed grey cast iron	300-700	GGL-NiCr 35 2	0.6678	
Sphäroguss	Nodular cast iron	-500	GGG60	0.7060	
Temperguss	Malleable cast iron	40-70	GTS55	0.8155	
Rein-Metalle, weich	Pure metals, soft	400-800 (120-310 HB)	Reineisen, Blei pure iron, lead	1.1003	
Aluminium-Legierungen, langspanend	Aluminium alloys, long chipping	100-400 (120-260 HB)	AlMg 3	3.3535	
			AlZnMgCu 1,5	3.4365	
Aluminium-Legierungen, kurzspanend	Aluminium alloys, short chipping	-400	G-AlSi 12	3.2581	
Kupfer-Legierungen, langspanend	Copper alloys, long chipping	150-250 (160-230 Hb)	MS63	2.0320	
			CuAl10Ni	2.0975	
Kupfer-Legierungen, kurzspanend	Copper alloys, short chipping	-500	MS58	2.0402	
Magnesium-Legierungen	Magnesium alloys	160-300	G-MgAl9Zn1	3.5912	
Thermoplaste	Thermoplastics	350-700 (150-280 HB)	PVC, Acrylglas PVC, acrylic glass		
Duroplaste	Duroplastics	20-40	Bakelit, Melamin		
Graphit	Graphite		Graphite	R8510	
Titan-Legierungen, mittelfest	Titanium alloys, medium strength	-950	TiAl5Sn2,5	3.7115	
			TiAl6V4	3.7165	
Titan-Legierungen, hochfest	Titanium alloys, high strength	900-140	TiAl6Sn2	3.7174	
Nickelbasis-Legierungen, mittelfest	Nickel based alloys, medium strength	-950	NiCr12Al6MoNb	2.4670	
Nickel-Basis-Legierungen, hochwarmfest	Heat resistant nickel based alloys, high strength	900-1400	NiCr19Fe19NbMo Inconel 718		
Hartguss	Chilled cast iron	300-600	Ni-hard, Ampco		
Gehärteter Stahl	Hardened steel	45-52 HRC 53-59 HRC			

Typenbeschreibung Type description

HSCline und Fräser für den Gesenk-und Formenbau HSCline and Milling Cutters for mould and die industry

		DIN (WN= Werknorm Fette Standard)	HM-Sorte Carbide Grade	Drallwinkel Helix angle λ	Kat.-Nr. Cat.-No.			Seite Page
					AL2 Plus	ALUUltra	Diamant beschichtet diamond coated	
	HSCline-Schaftfräser, kurz, lang, extra lang stirnseitig bis Mitte schneidend, gerade Stirn mit Eckenradius oder Kugelstirn Für HSC- und Hartbearbeitung HSCline End Mills, short, long, x-long Center cutting, square end with corner radius or ball nose Machining HSC and hardened steel	WN	LC620T	20°	1410C 1412C	●	●	316
	HSCline-Schaftfräser mini, kurz, lang, extra lang für spezielle Kleinstanwendungen Z=2 stirnseitig bis Mitte schneidend, HSC- und Hartbearbeitung HSCline Mini End Mills, short, long, extra-long for special, extremely small size applications Z=2 Center-Cutting. Machining HSC and hardened steel	WN	LC630T	30°	1415C 1419C	●		318
	HSCline-Schaftfräser in torischer Ausführung Mit Eckenradius oder Vollradius für 5-achs Bearbeitung 1. Wahl bei steilen Kavitäten und ziehendem Schnitt HSCline End Mills, Toroidal Version With corner radius or full radius for 5-axis machining 1. The choice for steep cavities and oblique shearing	WN	LC620T	20°	1433C 1422C	●	●	319
	Kugelschaftfräser, extra lang stirnseitig bis Mitte schneidend mit kegelig verstärktem Übergang zwischen Schneidenteil und Zylinderschaft Ball-nosed Copying End Mill, extra long center cutting with conically reinforced transition between cutting region and straight shank	WN	LW620 LC620T	30°	1511 1511C	●	●	320
	Schaftfräser Diamantbeschichtet für die Graphitbearbeitung mit gerader oder Kugelstirn extra hohe Schneidenlänge für große Zustelltiefen End Mills, diamond coated for graphite machining with square end or ball nose extra cutting length for large advance depths	WN	LC610A	50°			1420C 1421C	321
	Kugelschaftfräser, Zweisechneider kurz, lang für schwer zerspanbare Werkstoffe Zylinderschaft mit seitlicher Spannfläche Ball Nose Copying End Mill, 2-Flute short, long for difficult-to-machine materials straight shank and Weldon flat	6527B	LW630 LC630T	30°	1417 1417C	●		322

● = Auch in diesen Beschichtungen kurzfristig lieferbar
also available with these coatings at short notice

Typenbeschreibung Type description

HSCline und Fräser für den Gesenk-und Formenbau HSCline and Milling Cutters for mould and die industry

		DIN (WN = Werknorm Fette Standard)	HM-Sorte Carbide Grade	Drallwinkel Helix angle λ	Kat.-Nr. Cat.-No.				Seite Page
					unbe- schichtet uncoated	AL2 Plus	AL Ultra	Diamant beschichtet diamond coated	
	Kugelschaftfräser, Zweischneider kurz, lang für schwer zerspanbare Werkstoffe Zylinderschaft Ball Nose End Mills, 2-Flute short, long for difficult-to-machine materials straight shank	6527A/ 6528	LW630 LC630T	20°		1418 1418C	●		322
	Kugelschaftfräser, Vierschneider für vielfältige Anwendungen stirnseitig bis Mitte schneidend Zylinderschaft Ball Nose End Mills, 4-Flute for various applications Center cutting straight shank	6527A/ 6528	LW630 LC630T	30°		1588 1588C	●		323
	Kugelschaftfräser, Vierschneider für vielfältige Anwendungen stirnseitig bis Mitte schneidend Zylinderschaft mit seitlicher Spannfläche Ball Nose End Mills, 4-Flute for various applications Center cutting straight shank with Weldon flat	6527B	LW630 LC630T	30°		1589 1589C	●		323
	Schaftfräser stirnseitig bis Mitte schneidend hochgedrallt für das Schlichten von gehärteten Stählen End Mills center cutting with large helix angle for finishing hardened steels	6527A/ 6528	LC620X	50°		●	1413C	●	324
	Schaftfräser stirnseitig bis Mitte schneidend hochgedrallt für das Schlichten von gehärteten Stählen Zylinderschaft mit seitlicher Spannfläche End Mills center cutting, with large helix angle for finishing hardened steels straight shank with Weldon flat	6527B	LC620X	50°		●	1411C	●	324
	Schaftfräser mit Eckenradius stirnseitig bis Mitte schneidend hochgedrallt für das Schlichten von gehärteten Stählen End Mills with corner radius center cutting with large helix angle for finishing hardened steels	6527A/ 6528	LC620X	50°		●	1411C	●	324

● = Auch in diesen Beschichtungen kurzfristig lieferbar
also available with these coatings at short notice

Vollhartmetall
stirnseitig bis Mitte schneidend
NC-gerecht

Solid Carbide
center cutting
suitable for NC

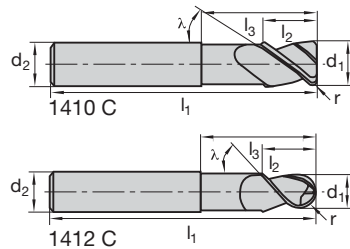

Katalog-Nr.	Cat.-No.	1410 C	1412 C
Typ	Type	HSCline	
Norm	Standard	Werknorm FETTE Standard	
Drallwinkel	Helix angle	$\lambda = 20^\circ$	
Zylinderschaft	Straight shank	DIN 6535 HA	
Beschichtung	Coating	AL2 Plus ²⁾	
Schneidstoffsorten ¹⁾	Cutting materials ¹⁾	LC620T	

d ₁	l ₂	l ₁	l ₃	d ₂ h 6	z	r	Ident No.	r	Ident No.	d ₁	l ₂	l ₁	l ₃	d ₂ h 6	z	r	Ident No.	r	Ident No.
1410 C									1412 C										
1	1,5	38	2,7	3	2	0,2	1122314	0,5	1122452	-	-	-	-	-	-	-	-	-	-
2	2	50	3,6	6	2	0,3	1122326	1	1122464	2	2	70	17	6	2	0,3	1122673	1	1300377
3	3	50	5,5	6	2	0,4	1122338	1,5	1122477	3	3	70	18	6	2	0,4	1122685	1,5	1300378
4	4	57	14,5	6	2	0,5	1122350	2	1122490	4	4	80	19	6	2	0,5	1122697	2	1300379
4	4	57	14,5	6	2	1	1110039	2,5	1122502	4	4	80	19	6	2	1	1110054	-	-
5	5	57	21	6	2	0,5	1110040	-	-	5	5	80	44	6	2	0,5	1110055	2,5	1300380
5	5	57	21	6	2	0,6	1122362	-	-	5	5	80	44	6	2	0,6	1122014	-	-
5	5	57	21	6	2	1	1110041	-	-	5	5	80	44	6	2	1	1110056	-	-
6	6	57	21	6	2	0,3	1110188	-	-	6	6	80	44	6	2	0,3	1110189	-	-
6	6	57	21	6	2	0,5	1110042	3	1122526	6	6	80	44	6	2	0,5	1110057	3	1300381
6	6	57	21	6	2	0,8	1122374	-	-	6	6	80	44	6	2	0,8	1122027	-	-
6	6	57	21	6	2	1	1110044	-	-	6	6	80	44	6	2	1	1110058	-	-
8	8	63	27	8	2	-	-	4	1122538	8	8	90	54	8	2	-	-	4	1300382
8	8	63	27	8	3	0,3	1110190	-	-	8	8	90	54	8	3	0,3	1110191	-	-
8	8	63	27	8	3	1	1122386	-	-	8	8	90	54	8	3	1	1122040	-	-
8	8	63	27	8	3	1,5	1110045	-	-	8	8	90	54	8	3	1,5	1110059	-	-
8	8	63	27	8	3	2	1110046	-	-	8	8	90	54	8	3	2	1110060	-	-
10	10	72	32	10	2	-	-	5	1122550	10	10	100	60	10	2	-	-	5	1300384
10	10	72	32	10	3	0,5	1110192	-	-	10	10	100	60	10	3	0,5	1110193	-	-
10	10	72	32	10	3	1	1110047	-	-	10	10	100	60	10	3	1	1110062	-	-
10	10	72	32	10	3	1,3	1122398	-	-	10	10	100	60	10	3	1,3	1122053	-	-
10	10	72	32	10	3	1,5	1110048	-	-	10	10	100	60	10	3	1,5	1110063	-	-
10	10	72	32	10	3	2	1110049	-	-	10	10	100	60	10	3	2	1110064	-	-
12	12	83	38	12	2	-	-	6	1122562	12	12	110	65	12	2	-	-	6	1300385
12	12	83	38	12	3	0,5	1110194	-	-	12	12	110	65	12	3	0,5	1110195	-	-
12	12	83	38	12	3	1	1110050	-	-	12	12	110	65	12	3	1	1110065	-	-
12	12	83	38	12	3	1,5	1110051	-	-	12	12	110	65	12	3	1,5	1110066	-	-
12	12	83	38	12	3	1,6	1122411	-	-	12	12	110	65	12	3	1,6	1122066	-	-
12	12	83	38	12	3	2	1110053	-	-	12	12	110	65	12	3	2	1110067	-	-
16	16	92	44	16	4	2	1122425	8	1122574	16	16	130	82	16	4	2	1122080	8	1300386
20	20	104	54	20	4	2	1110197	-	-	20	20	150	100	20	4	2	1110198	-	-
20	20	104	54	20	4	2,5	1122438	10	1122587	20	20	150	100	20	4	2,5	1121609	10	1121625

¹⁾ Sortenbeschreibung siehe Seite 22
¹⁾ Description of grades see page 22

²⁾ Mit Diamantbeschichtung zur Graphitbearbeitung lieferbar
²⁾ With diamond coating for machining graphite upon request

Schnittwertempfehlungen ab Seite 326
Cutting data recommendations starting page 326

**Vollhartmetall
stirnseitig bis Mitte schneidend
NC-gerecht**

**Solid Carbide
center cutting
suitable for NC**

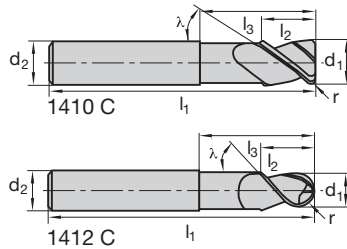

Katalog-Nr.	Cat.-No.	1410 C	1412 C
Typ	Type	HSCline	
Norm	Standard	Werknorm FETTE Standard	
Drallwinkel	Helix angle	$\lambda = 20^\circ$	
Zylinderschaft	Straight shank	DIN 6535 HA	
Beschichtung	Coating	AL2 Plus ²⁾	
Schneidstoffsorten ¹⁾	Cutting materials ¹⁾	LC620T	

d ₁	l ₂	l ₁	l ₃	d ₂ h 9	z	l	Ident No.	d	Ident No.
extra lang extra long									
2	2	120	17	6	2	0,3	1122093	1	1300397
3	3	120	18	6	2	0,4	1122107	1,5	1300398
4	4	160	19	6	2	0,5	1122119	2	1300399
5	5	160	94	6	2	0,6	1122132	2,5	1300400
6	6	160	94	6	2	0,8	1122145	3	1300401
8	8	160	94	8	2	1	1122158	4	1300402
10	10	160	94	10	2	1,3	1122171	5	1300403
12	12	200	114	12	2	1,6	1122185	6	1300404
16	16	200	114	16	4	2	1122198	8	1300405
20	20	230	144	20	4	2,5	1121611	10	1121626

¹⁾ Sortenbeschreibung siehe Seite 22
¹⁾ Description of grades see page 22

²⁾ Mit Diamantbeschichtung zur Graphitbearbeitung lieferbar
²⁾ With diamond coating for machining graphite upon request

Schnittwertempfehlungen ab Seite 326
Cutting data recommendations starting page 326

**Vollhartmetall
stirnseitig bis Mitte schneidend
NC-gerecht**

**Solid Carbide
center cutting
suitable for NC**

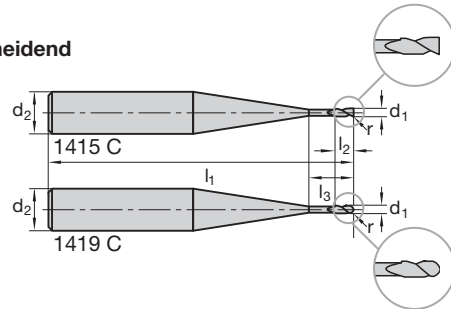

Katalog-Nr.	Cat.-No.	1415 C	1419 C
Typ	Type	HSCline	
Norm	Standard	Werknorm FETTE Standard	
Drallwinkel	Helix angle	$\lambda = 30^\circ$	
Zylinderschaft	Straight shank	DIN 6535 HA	
Beschichtung	Coating	AL2 Plus	
Schneidstoffsorten ¹⁾	Cutting materials ¹⁾	LC630T	

d_1	l_2	l_1	l_3	d_2 h 6	z	Ident No.	r	Ident No.
kurz short								
0,4	0,8	40	1,3	3	2	1121872	0,2	1121883
0,5	1	40	1,5	3	2	1121873	0,25	1121884
0,6	1,2	40	1,7	3	2	1121874	0,3	1121885
0,8	1,6	40	2,1	3	2	1121875	0,4	1121886
1	2,5	40	3	4	2	1121876	0,5	1121887
1,2	3	40	3,5	4	2	1121877	0,6	1121888
1,4	3	40	3,5	4	2	1121878	0,7	1121890
1,5	4	40	4,5	4	2	1121879	0,75	1121891
1,6	4	40	4,5	4	2	1121880	0,8	1121892
1,8	5	40	5,5	4	2	1121881	0,9	1121893
2	6	40	6,5	4	2	1121882	1	1121894
lang long								
0,5	1	50	2,5	4	2	1331056	0,25	1331047
1	2,5	50	5	4	2	1331057	0,5	1331048
1,5	4	50	7,5	4	2	1331041	0,75	1331049
2	6	50	10	4	2	1331042	1	1331050
extra lang extra long								
0,5	1	50	5	4	2	1331043	0,25	1331051
1	2,5	50	10	4	2	1331044	0,5	1331052
1,5	4	50	15	4	2	1331045	0,75	1331053
2	6	50	20	4	2	1331046	1	1331054

¹⁾ Sortenbeschreibung siehe Seite 22

¹⁾ Description of grades see page 22

Schnittwertempfehlungen ab Seite 326

Cutting data recommendations starting page 326

Vollhartmetall
stirnseitig bis Mitte schneidend
NC-gerecht

Solid Carbide
center cutting
suitable for NC

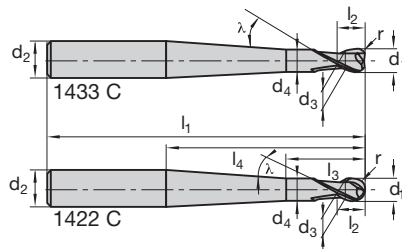

Katalog-Nr.	Cat.-No.	1433 C	1422 C
Typ	Type	HSCline	
Drallwinkel	Helix angle	$\lambda = 20^\circ$	
Zylinderschaft	Straight shank	DIN 6535 HA	
Beschichtung	Coating	AL2 Plus ²⁾	
Schneidstoffsorten ¹⁾	Cutting materials ¹⁾	LC620T	
Besonderheiten	Special features	Torische Radius- und Schaftfräser mit Halseinschnürung Toroidal ball nose end mill with neck constriction	

d ₁	r	d ₃	l ₂	d ₄	l ₃	l ₄	l ₁	d ₂	Ident No.	Ident No.
4	0,5	3,9	0,7	3,5	18,4	44	80	6	1300900	-
5	0,5	4,9	5,4	4,5	20,1	44	80	6	1300901	-
6	0,5	5,9	5,4	5,2	21,1	44	80	6	1300902	-
6	1	5,8	1,4	5,2	21,1	44	80	6	1300903	-
6	1,5	5,7	2,1	5,2	21,1	44	80	6	1300904	-
8	1	7,8	1,4	7,2	31,1	54	90	8	1300905	-
8	1,5	7,7	2,1	7,2	31,1	54	90	8	1300906	-
10	1	9,8	1,4	9	31,4	60	100	10	1300907	-
10	1,5	9,7	2,1	9	31,4	60	100	10	1300909	-
10	2	9,6	2,8	9	31,5	60	100	10	1300910	-
12	1	11,8	1,4	10,6	38,3	65	110	12	1300911	-
12	1,5	11,7	2,1	10,6	38,3	65	110	12	1300912	-
12	2	11,6	2,8	10,6	38,3	65	110	12	1300913	-
12	3	11,4	4,3	10,6	38,3	65	110	12	1300914	-
4	2	3,6	2,8	3,2	17,3	44	80	6	-	1300915
5	2,5	4,5	3,6	4	21,1	44	80	6	-	1300916
6	3	5,4	4,3	4,8	26,8	44	80	6	-	1300917
8	4	7,3	5,7	6,8	29,6	54	90	8	-	1300918
10	5	9,1	7,1	8,5	31,4	60	100	10	-	1300919
12	6	10,9	8,5	10	36,4	65	110	12	-	1300920

¹⁾ Sortenbeschreibung siehe Seite 22
¹⁾ Description of grades see page 22

²⁾ Mit Diamantbeschichtung zur Graphitbearbeitung lieferbar
²⁾ With diamond coating for machining graphite upon request

Schnittwertempfehlungen ab Seite 326
 Cutting data recommendations starting page 326

Kugelkopierschaftfräser, Vierschneider, extra lang Ball Nose Copying End Mills, 4-Flute, extra long



Katalog-Nr.	Cat.-No.	1511	1511 C
Typ	Type	N	
Drallwinkel	Helix angle	$\lambda = 20^\circ$	
Zylinderschaft	Straight shank	DIN 6535 HA	
Beschichtung	Coating	-	AL2 Plus ²⁾
Schneidstoffsorten ¹⁾	Cutting materials ¹⁾	LW620	LC620T
Besonderheiten	Special features	mit kegelig verstärktem Übergang zwischen Schneidteil und Zylinderschaft with enlarged tapered run-out between cutting portion and shank	

d ₁	r	l ₂	l ₃	l ₄	l ₁	d ₂	z	Ident No.	Ident No.
4	2	5,4	28	124	160	6	4	1142840	1301040
6	3	7,6	34	120	160	8	4	1142842	1301041
8	4	9,25	40	115	160	10	4	1142844	1301042

¹⁾ Sortenbeschreibung siehe Seite 22

¹⁾ Description of grades see page 22

²⁾ Mit Diamantbeschichtung zur Graphitbearbeitung lieferbar

²⁾ With diamond coating for machining graphite upon request

Schnittwertempfehlungen ab Seite 326

Cutting data recommendations starting page 326

**Vollhartmetall
stirnseitig bis Mitte schneidend**

**Solid Carbide
center cutting**

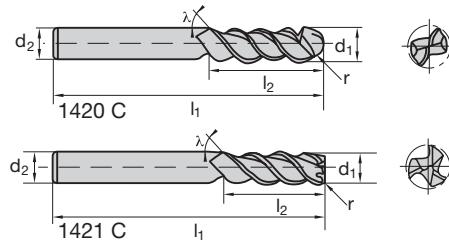

Katalog-Nr.	Cat.-No.	1420 C	1421 C
Typ	Type	HSCline	
Norm	Standard	Werknorm FETTE Standard	
Drallwinkel	Helix angle	$\lambda = 50^\circ$	
Zylinderschaft	Straight shank	DIN 6535 HA	
Beschichtung	Coating	Diamantbeschichtung diamond coated	
Schneidstoffsorten ¹⁾	Cutting materials ¹⁾	LC610A	

d_1	r	l_2	l_1	d_2	z	Ident No.	Ident No.
1	0,5	25	75	3	2	1300133	-
2	1	25	75	3	2	1300172	-
3	1,5	25	75	3	2	1300187	-
4	2	25	75	4	2	1300295	-
5	2,5	25	75	5	2	1300347	-
6	3	25	75	6	2	1300383	-
2	1	25	100	3	2	1300445	-
3	1,5	25	100	3	2	1300490	-
4	2	40	100	4	2	1300576	-
6	3	40	100	6	2	1300622	-
4	2	50	130	5	2	1300631	-
6	3	50	130	6	2	1300659	-
2	0,3	25	75	3	3	-	1300721
3	0,3	25	75	3	3	-	1300851
4	0,3	25	75	4	3	-	1300852
4	0,5	25	75	4	3	-	1300853
5	0,3	25	75	5	3	-	1300854
5	0,5	25	75	5	3	-	1300856
6	0,5	25	75	6	3	-	1300857
4	0,3	25	100	4	3	-	1300858
4	0,5	25	100	4	3	-	1300859
6	0,5	40	100	6	3	-	1300860
6	0,5	50	130	6	3	-	1300861

¹⁾ Sortenbeschreibung siehe Seite 22

¹⁾ Description of grades see page 22

Schnittwertempfehlungen ab Seite 326

Cutting data recommendations starting page 326

Kugelschaftfräser, Zweischneider, lang Ball Nose End Mills, 2-Flute, long

Vollhartmetall
stirnseitig bis Mitte schneidend
NC-gerecht

Solid Carbide
center cutting
suitable for NC

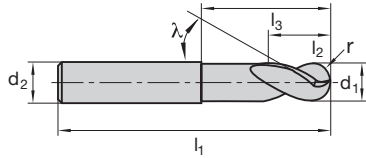

Katalog-Nr.	Cat.-No.	1418	1418 C	1417	1417 C
Typ	Type	N			
Norm	Standard	DIN 6527 A / DIN 6528		DIN 6527 B	
Drallwinkel	Helix angle	$\lambda = 30^\circ$			
Zylinderschaft	Straight shank	□ DIN 6535 HA		□ DIN 6535HB	
Beschichtung	Coating	-	AL2 Plus	-	AL2 Plus
Schneidstoffsorten ¹⁾	Cutting materials ¹⁾	LW630	LC630T	LW630	LC630T

d ₁ h 10	r	l ₂	l ₁	l ₃	d ₂ h 6	Ident No.	Ident No.	Ident No.	Ident No.
3	1,5	7	57	21	6	1120146	1122569	1120236	1331040
4	2	8	57	21	6	1120147	1122582	1120237	1331029
5	2,5	10	57	21	6	1120148	1122594	1120238	1331030
6	3	10	57	21	6	1120149	1122606	1120239	1331031
8	4	16	63	27	8	1120150	1122618	1120240	1331032
10	5	19	72	32	10	1120151	1122631	1120241	1331033
12	6	22	83	38	12	1120152	1122643	1120242	1331034
14	7	22	83	38	14	1120153	1122656	1120243	1331035
16	8	26	92	44	16	1120154	1122668	1120244	1331036
18	9	26	92	44	18	1120155	1122680	1120245	1331039
20	10	32	104	54	20	1120156	1122692	1120246	1331038

¹⁾ Sortenbeschreibung siehe Seite 22

¹⁾ Description of grades see page 22

Schnittwertempfehlungen ab Seite 326

Cutting data recommendations starting page 326

Vollhartmetall
stirnseitig bis Mitte schneidend
NC-gerecht

Solid Carbide
center cutting
suitable for NC

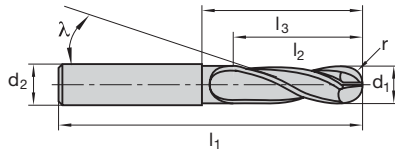

Katalog-Nr.	Cat.-No.	1588	1588 C	1589	1589 C
Typ	Type	N			
Norm	Standard	DIN 6527 A / DIN 6528		DIN 6527 B	
Drallwinkel	Helix angle	$\lambda = 30^\circ$			
Zylinderschaft	Straight shank	□ DIN 6535 HA		□ DIN 6535HB	
Beschichtung	Coating	-	AL2 Plus	-	AL2 Plus
Schneidstoffsorten ¹⁾	Cutting materials ¹⁾	LW630	LC630T	LW630	LC630T

d ₁	r	l ₂	l ₁	l ₃	d ₂	Ident No.	Ident No.	Ident No.	Ident No.
3	1,5	8	57	21	6	1120170	1122184	1120180	1301045
4	2	11	57	21	6	1120171	1122197	1120181	1301046
5	2,5	13	57	21	6	1120172	1122210	1120182	1301047
6	3	13	57	21	6	1120173	1122223	1120183	1301048
8	4	19	63	27	8	1120174	1122236	1120184	1301049
10	5	22	72	32	10	1120175	1122249	1120185	1301050
12	6	26	83	38	12	1120176	1122261	1120186	1301051
14	7	14	83	38	12	1120177	1122275	1120187	1301052
16	8	32	92	44	16	1120178	1122288	1120188	1301053
20	10	38	104	54	20	1120179	1122301	1120189	1301054

¹⁾ Sortenbeschreibung siehe Seite 22
¹⁾ Description of grades see page 22

Schnittwertempfehlungen ab Seite 326
 Cutting data recommendations starting page 326

**Vollhartmetall
NC-gerecht**

**Solid Carbide
suitable for NC**

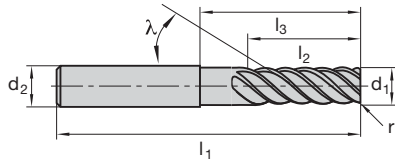

Katalog-Nr.	Cat.-No.	1413 C	1411 C	1443 C
Typ	Type	SN 50		
Norm	Standard	DIN 6527 A / DIN 6528	DIN 6528 B	FETTE Standard
Drallwinkel	Helix angle	$\lambda = 50^\circ$		
Zylinderschaft	Straight shank	DIN 6535 HA	DIN 6535 HB	DIN 6535 HA
Beschichtung	Coating	AL Ultra		
Schneidstoffsorten ¹⁾	Cutting materials ¹⁾	LC620X		
Besonderheiten	Special features	besonders gut zur Hartbearbeitung geeignet well suited for hard machining		

d ₁	r	l ₂	l ₁	l ₃	d ₂ h 6	z	Ident No.	Ident No.	Ident No.
2	-	7	38	15	3	4	1121631	-	-
3	-	8	38	16	3	4	1121630	-	-
3	-	8	57	16	6	4	-	1110068	-
4	-	11	57	19	6	4	1121628	1110069	-
5	-	13	57	21	6	4	1121627	1110070	-
6	-	13	57	21	6	6	1121301	1110071	-
8	-	19	63	27	8	6	1121302	1110072	-
10	-	22	72	32	10	6	1121303	1110073	-
12	-	26	83	38	12	8	1121304	1110074	-
16	-	32	92	44	16	8	1121305	1110075	-
20	-	38	104	54	20	8	1121306	1110076	-
3	0,3	8	57	16	4	4	-	-	1301020
4	0,3	11	57	19	4	4	-	-	1301021
5	0,5	13	57	21	4	4	-	-	1301022
6	0,5	13	57	21	6	6	-	-	1301023
6	1	13	57	21	6	6	-	-	1301024
8	0,5	19	63	27	8	6	-	-	1301025
8	1	19	63	27	8	6	-	-	1301026
10	0,5	22	72	32	10	6	-	-	1301027
10	1	22	72	32	10	6	-	-	1301028
10	1,5	22	72	32	10	6	-	-	1301029
10	2	22	72	32	10	6	-	-	1301030
12	0,5	26	83	38	12	8	-	-	1301031
12	1	26	83	38	12	8	-	-	1301032
12	1,5	26	83	38	12	8	-	-	1301033
12	2	26	83	38	12	8	-	-	1301034
16	2	32	92	44	16	8	-	-	1301036
16	1	32	92	54	16	8	-	-	1301035
20	1	38	104	54	20	8	-	-	1301037
20	2	38	104	54	20	8	-	-	1301038

¹⁾ Sortenbeschreibung siehe Seite 22

¹⁾ Description of grades see page 22

Schnittwertempfehlungen ab Seite 326

Cutting data recommendations starting page 326

Anwendungsbeispiel

Application example

Bearbeitung eines Gesenks für Meißel
Machining a cutting tool die

Werkzeug: HSCline VHM Schaftfräser
Werkstoff: 1.2714 (56 NiCrMoV7) 54 HRC
HM-Sorte: LC620T AL2Plus
Tool: HSCline Solid Carbide End Mill
Material: 1.2714 (56 NiCrMoV7) 54 HRC
Carbide grade: LC620T AL2Plus

Schnittwerte trocken:

Cutting data dry:

$v_c = 300 \text{ m/min}$
 $n = 15000 \text{ min}$
 $f_z = 0,13 \text{ mm}$
 $v_f = 4000 \text{ mm/min}$
 $a_e = 0,2 \text{ mm}$
 $a_p = 0,2 \text{ mm}$

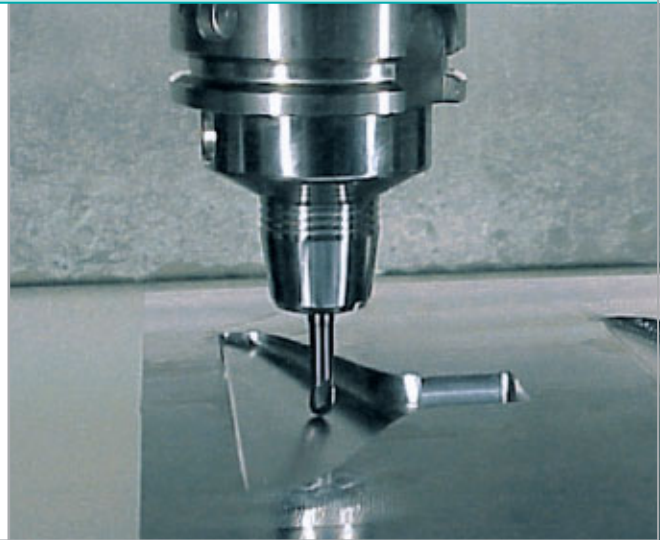

Werkstoff	Material	R _m /UTS (N/mm ²)	Beispiel Example	DIN-No.
Unlegierter Baustahl	Plain carbon steel	-700	St 52	1.0052
Automatenstahl	Free cutting steel	-700	9 SMn 28	1.0715
Baustahl	Structural alloy steel	500-950	Ck 45 26 CrMo 4	1.1191 1.7219
Vergütungsstahl, mittelfest	Heat-treatable steel, medium strength	500-950	42 CrMo 4 50 CrV 4	1.7225 1.2241
Stahlguss	Cast steel	-950	GS 40	1.0416
Einsatzstahl	Case hardening steel	-950	16 MnCr 5	1.7131
Rost- und säurebeständiger Stahl, ferritisch, martensitisch	Stainless steel, ferritic, martensitic	500-950	X 10 Cr 13 X 12 CrMoS 17 X 35 CrMo 17	1.4006 1.4104 1.4122
Vergütungsstahl, hochfest	Heat-treatable steel, high strength	950-1400	42 CrMo 4 30 CrNiMo 8	1.7225 1.6580
Nitrierstahl, vergütet	Nitriding steel	950-1400	34 CrAl 6	1.8504
Werkzeugstahl	Tool steel	950-1400	X 38 CrMoV 5 1 X 155 CrVMo 12 1	1.2343 1.2379
Rost- und säurebeständiger Stahl, austenitisch	Stainless steel, austenitic	500-950	X 5 CrNi 18 10 X10 CrNiMo 18 10	1.4301 1.4571
Martensitaushärtbarer Stahl	Maraging steel			1.2709
Grauguss	Grey cast iron	-550	GG25	0.6025
Legierter Grauguss	Alloyed grey cast iron	300-700	GGL-NiCr 35 2	0.6678
Sphäroguss	Nodular cast iron	-500	GGG60	0.7060
Temperguss	Malleable cast iron	40-70	GTS55	0.8155
Rein-Metalle, weich	Pure metals, soft	400-800 (120-310 HB)	Reineisen, Blei pure iron, lead	
Aluminium-Legierungen, langspanend	Aluminium alloys, long chipping	100-400 (120-260 HB)	AlMg 3 AlZnMgCu 1,5	3.3535 3.4365
Aluminium-Legierungen, kurzspanend	Aluminium alloys, short chipping	-400	G-AlSi 12	3.2581
Kupfer-Legierungen, langspanend	Copper alloys, long chipping	150-250 (160-230 Hb)	MS63 CuAl10Ni	2.0320 2.0975
Kupfer-Legierungen, kurzspanend	Copper alloys, short chipping	-500	MS58	2.0402
Magnesium-Legierungen	Magnesium alloys	160-300	G-MgAl9Zn1	3.5912
Thermoplaste	Thermoplastics	350-700 (150-280 HB)	PVC, Acrylglas PVC, acrylic glass	
Duroplaste	Duroplastics	20-40	Bakelit, Melamin	
Graphit	Graphite		Graphite	R8510
Titan-Legierungen, mittelfest	Titanium alloys, medium strength	-950	TiAl5Sn2,5 TiAl6V4	3.7115 3.7165
Titan-Legierungen, hochfest	Titanium alloys, high strength	900-140	TiAl6Sn2	3.7174
Nickelbasis-Legierungen, mittelfest	Nickel based alloys, medium strength	-950	NiCr12Al6MoNb	2.4670
Nickel-Basis-Legierungen, hochwarmfest	Heat resistant nickel based alloys, high strength	900-1400	NiCr19Fe19NbMo Inconel 718	
Hartguss	Chilled cast iron	300-600	Ni-hard, Ampco	
Gehärteter Stahl	Hardened steel	45-52 HRC 53-59 HRC 60-65 HRC		

Die angegebenen Schnittdaten sind Standardwerte und müssen auf die vorhandenen Bedingungen abgestimmt werden.
The cutting data quoted includes standard values, and must be adjusted to the actual conditions.

	Schnittgeschwindigkeit Cutting speed $v_c = \text{m/min}$			Vollhartmetall Solid carbide						
	beschichtet coated	beschichtet coated	unbeschichtet uncoated	Vorschub pro Zahn bei Fräser-Ø d_1 f_z [mm] Feed per tooth at cutter dia. Ø d_1 f_z [mm]						
	HSCline SN50	N	N	≤ 1	1-2	2-4	4-6	6-10	12-16	> 16
	600	210	300	0,02	0,03	0,04	0,08	0,1	0,13	0,16
	600	210	300	0,02	0,03	0,04	0,08	0,1	0,13	0,16
	500	210	300	0,02	0,03	0,04	0,08	0,1	0,13	0,16
	450	175	250	0,01	0,012	0,2	0,05	0,08	0,1	0,15
	450	112	160	0,008	0,01	0,015	0,05	0,08	0,1	0,12
	400	112	160	0,008	0,01	0,015	0,04	0,08	0,1	0,12
	300	40	60	0,008	0,012	0,015	0,04	0,08	0,1	0,12
	350	175	250	0,01	0,02	0,04	0,06	0,08	0,11	0,14
	300	175	250	0,01	0,02	0,04	0,06	0,08	0,11	0,14
	250	175	250	0,01	0,02	0,04	0,06	0,08	0,11	0,14
	240-400	40	60	0,01	0,03	0,05	0,07	0,09	0,11	0,13
	240-400	40	60	0,01	0,03	0,05	0,07	0,09	0,11	0,13
	600	154	220	0,015	0,03	0,07	0,01	0,012	0,15	0,18
	500	112	160	0,015	0,025	0,055	0,075	0,095	0,12	0,16
	350	112	160	0,015	0,025	0,055	0,075	0,095	0,12	0,16
	350	90	130	0,045	0,03	0,07	0,01	0,012	0,15	0,18
	1000	140	200	0,015	0,03	0,06	0,08	0,1	0,12	0,15
	1000	900		0,015	0,04	0,055	0,075	0,1	0,14	0,2
	800	250		0,01	0,03	0,045	0,065	0,09	0,12	0,16
	1000	200	280	0,01	0,03	0,045	0,065	0,09	0,12	0,16
	700	175	250	0,01	0,025	0,04	0,06	0,08	0,11	0,15
		400		0,02	0,04	0,06	0,08	0,1	0,12	0,15
		250		0,03	0,05	0,07	0,09	0,11	0,13	0,16
		300		0,02	0,04	0,06	0,08	0,1	0,12	0,15
	1200			0,015	0,018	0,05	0,09	0,11	0,14	0,18
	180	60		0,01	0,02	0,04	0,07	0,09	0,11	0,13
	120	40		0,01	0,015	0,035	0,065	0,085	0,1	0,12
	150	80	30	0,01	0,02	0,04	0,07	0,09	0,11	0,13
	100	60	20	0,01	0,015	0,035	0,065	0,085	0,1	0,12
	200	80	40	0,01	0,015	0,02	0,04	0,065	0,08	0,1
	350			0,02	0,033	0,035	0,058	0,069	0,092	0,11
	300			0,015	0,028	0,029	0,052	0,063	0,087	0,095
	250			0,01	0,02	0,023	0,046	0,058	0,081	0,09

Gültigkeit der Diagramme für $a_p \geq 0,5 \cdot d_1$ bzw. für $a_p \geq 0,5 \cdot d_4$ sonst Berechnungsformeln siehe unten
 Diagrams are valid respectively otherwise see formula below

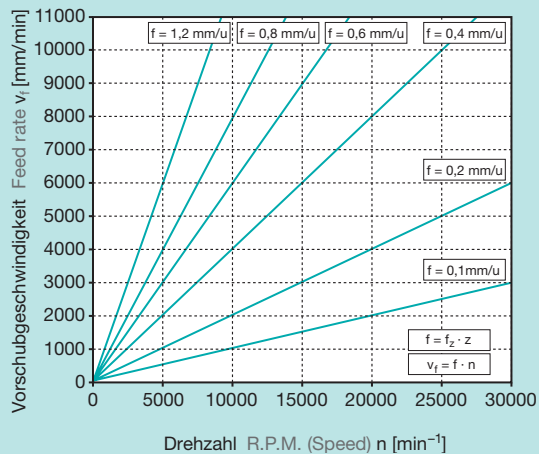
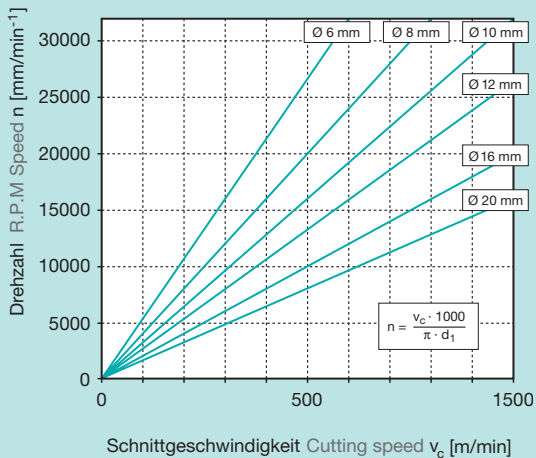

Kugelkopierfräser Ball Nose Copying Milling Cutter

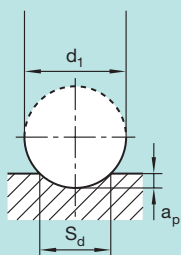

Kugelkopierfräser mit einer Schnitttiefe von
 Ball Nose Copying Milling Cutter with depth of cut
 $a_p < 0,5 \cdot d_1$

$$n = \frac{v_c \cdot 1000}{2 \cdot \pi \sqrt{d_1 \cdot a_p - a_p^2}} \quad [\text{min}^{-1}]$$

a_p = Schnitttiefe
 Depth of cut [mm]

S_d = Schnittkreis-Ø
 Cutting circle dia. [mm]

d_1 = Fräser-Ø
 Milling Cutter diameter [mm]

$$S_d = 2 \cdot \sqrt{d_1 \cdot a_p - a_p^2}$$

Fräser mit Eckenradius Milling Cutter with corner radius

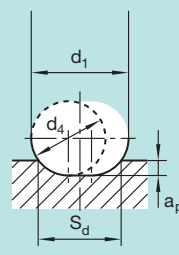

Fräser mit einer Schnitttiefe von
 Cutter with depth of cut
 $a_p < 0,5 \cdot d_4$

$$n = \frac{v_c \cdot 1000}{(d_1 - d_4 + 2 \cdot \sqrt{d_4 \cdot a_p - a_p^2}) \cdot \pi} \quad [\text{min}^{-1}]$$

$d_4 = 2 \cdot \text{Eckenradius-Corner radius}$ [mm]

$$S_d = d_1 - d_4 + 2 \cdot \sqrt{d_4 \cdot a_p - a_p^2}$$

z = Zähnezahl
 No. of teeth

f_z = Vorschub/Zahn
 Feed/Tooth [mm]

f = Vorschub/Umdrehung
 Feed/Revolution [mm/u]

HSC-Schaftfräser mit gerader Stirn
HSC End Mill Square

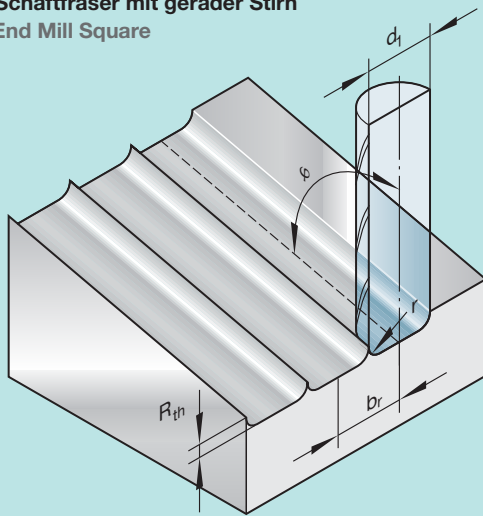

$$R_{th} = a \cdot \sin\varphi \cdot \left(1 - \sqrt{1 - \frac{b_r^2}{4 \cdot a^2}} \right)$$

$$a = \frac{1}{2} d_1 - r + r \cdot \sin\varphi$$

HSC-Schaftfräser mit runder Stirn
HSC End Mill Ball Nose

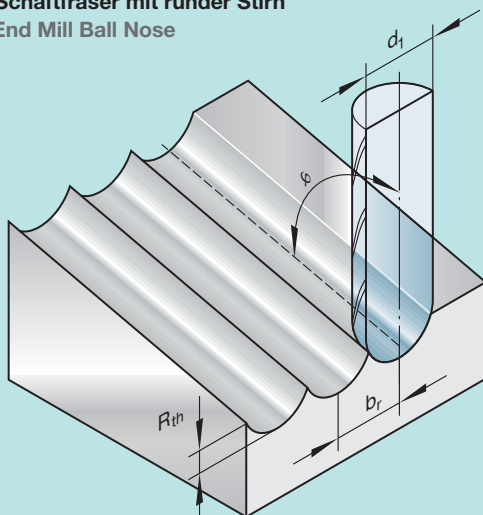

$$R_{th} = \frac{d_1}{2} - \sqrt{\frac{d_1^2 - b_r^2}{4}}$$

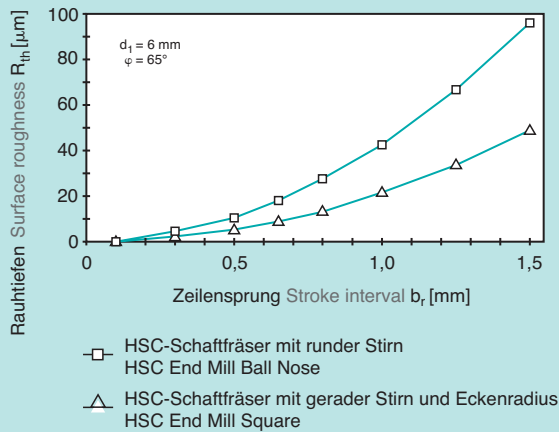

r = Eckenradius r = Corner radius
 d_1 = Fräser-Ø d_1 = Milling Cutter diameter
 φ = Fräser-Anstellwinkel φ = Milling Cutter setting angle

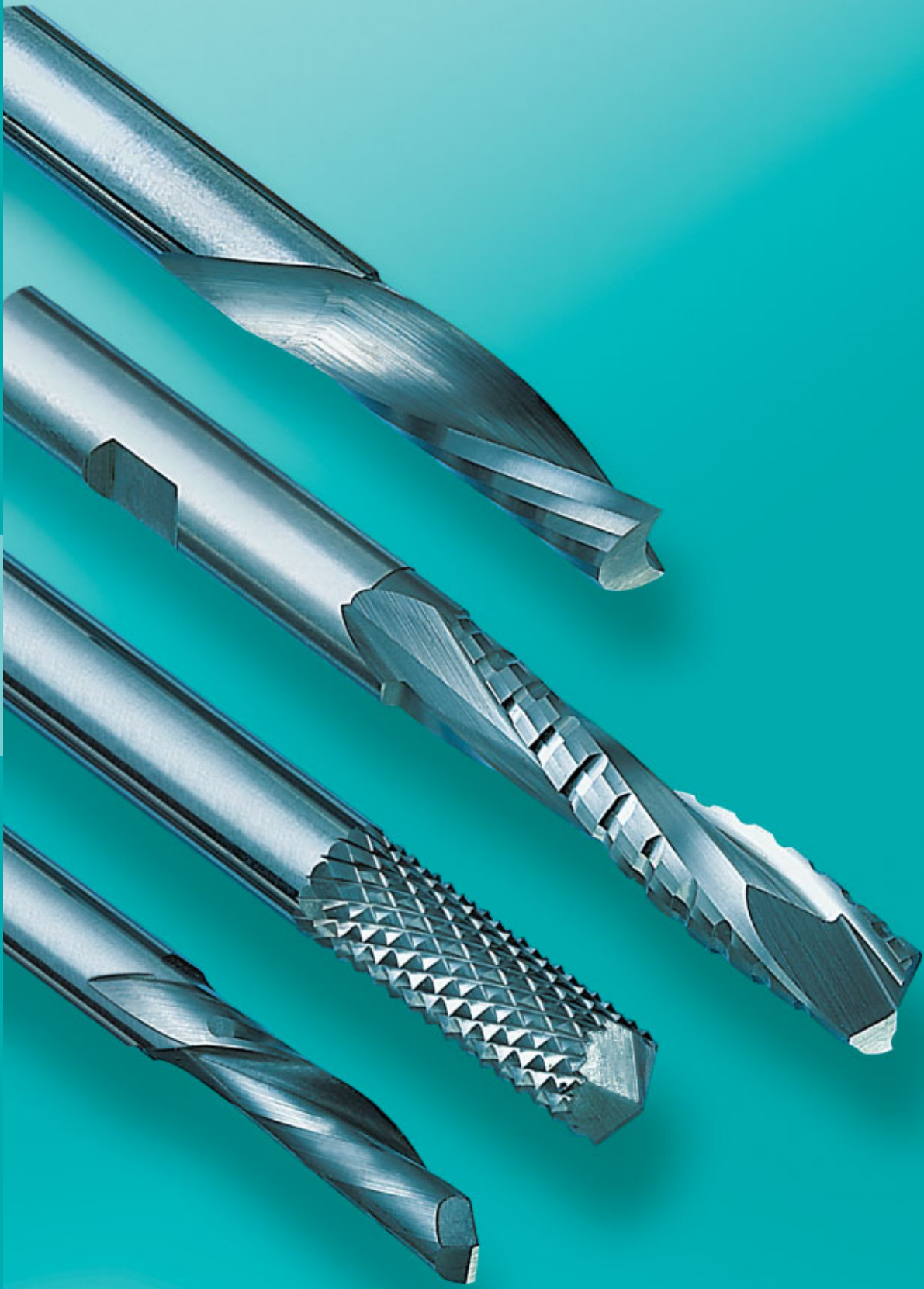

AIRline und Schafffräser zur Aluminium- und Kunststoffbearbeitung

AIRline and End Mills for aluminium and plastic machining

Auswahlübersicht Selection table	332, 334
Typenbeschreibung Type description	336
AIRline Schafffräser AIRline End Mills	
Zwei- und Dreischneider, lang 2 and 3 Flutes, long für Aluminium/Thermoplaste for aluminium and thermoplastics	338
auch mit innerer Kühlmittelzufuhr also with internal coolant supply	339
Schafffräser End Mills	
Einschneider Single Flute für Al-Bleche/-Pakete for aluminium sheets and packages	340
Schafffräser End Mills	
Zweischneider, lang 2 Flutes, long für Al-Bleche/Aluminium for aluminium sheets and packages	344
Oberfräser Router	
Einschneider, kurz, lang Single Flute, short, long für harte Kunststoffe for hard plastics	345
Oberfräser Router	
Zwei- und Dreischneider, kurz, lang 2 and 3 Flutes, short, long für Acryl und harte Kunststoffe for acrylic and hard plastics	346
Oberfräser Router	
Einschneider, lang Single Flute, long für weiche Kunststoffe for soft plastics	347
Oberfräser Router	
Zweischneider 2 Flutes für harte und weiche Kunststoffe for hard and soft plastics	348
Schafffräser End Mills	
Zweischneider 2 Flutes für harte und weiche Kunststoffe for hard and soft plastics	349
Schafffräser, lang End Mills, long	
für Verbundwerkstoffe for composites	350
Profilfräser End Mills for profiling	
Zweischneider 2 Flutes für Abrunden von Kunststoffen for edge rounding of plastics	351
PKD-bestückte Fräser PCD Tipped Slotting End Mills	
Zweischneider 2 Flutes Anfasen von Kunststoffen Chamfering	352
HM-bestückte Sägeblätter und Zubehör Carbide Tipped Slitting Saws and spare parts	
für Kunststoffe for plastics	355
Schnittwertempfehlungen Cutting data recommendations	357

Auswahlübersicht Selection table

Schafffräser zur Aluminium- und Kunststoffbearbeitung End Mills for aluminium and plastic machining

<ul style="list-style-type: none"> ● sehr gut geeignet well suited ○ auch geeignet also suited 							
Typ Type							
K = kurz short L = lang long Ausführung Design							
Zähnezahl No. of teeth							
Drallwinkel Helix angle							
Schneidstoff Cutting material							
Seite Page							
	Werkstoff- bezeichnung	Material	Material- bezeichnung	Material description	Kurzbez. Abbreviation DIN-No.	Zugfestigkeit Tensile strength (N/mm ²)	Handelsname Brand name
	Aluminium- legierungen, langspanend	Aluminium alloys, long chipping	Reinaluminium	Aluminium	3.3308		AL99, 9Mg0,5
			Knetlegierungen, weich	Malleable alloys	3.3535	~250	ALMg 3 F24
			Knetlegierungen, ausgehärtet	Hardened casting alloys	3.4365	- 550	ALZnMgCu1,5 F53
	Aluminium- legierungen, kurzspanend	Aluminium alloys, short chipping	Gusslegierungen bis 12% Si	Casting alloys with < 12% Si	3.3292	- 450	GD-ALMg 9
			Gusslegierungen über 12% Si	Casting alloys with > 12% Si	3.2582	- 550	GD-ALSI12
	Elastomere, Schaum- stoffe	Elastomere, Foam	Kautschuk- Verbindungen	Rubber compounds	SBR, EPDM	4 - 25	Polysar, Buna SL, Buna EP
			Weichschaumstoffe	Soft foams	PUR	70 - 80	Ureol, Baydur
			Hartschaumstoffe	Hard foams	TSG, RSG		
	Thermo- plaste	Thermo- plastics	Acrylnitril- Butadien-Styrol	Acrylonitrile- butadiene-styrene	ABS	38 - 50	Lustran, Novodur, Terluran, Vestodur
			Polypropylen	Polypropylene	PP, PP-C	14 - 40	Hostalen, Novolen, Eltex, Vestolen
			Polyvinylchlorid	Polyvinyl chloride	PVC	10 - 20	Trovidur, Hostalit, Vestolit, Vinoflex, Vinnol
			Polyethylen	Polyethylene	PE, PE-HD, PE-LD	22 - 40	Baylon, Sustylen, Hosta- lem, Lumpolen, Vestolen
			Polycarbonat	Polycarbonate	PC	65 - 75	Bayfol, Makrolon, Stapron, Lexan, Merlon
			Polystyrol	Polystyrene	PS	30 - 60	Bucara, Langolen, Hostyren, Polystyrol
			Acrylnitril/ Styrol/Acrylester	Acrylonitrile- styrene-acrylate	ASA	45 - 65	Polyman, Luran s
			Polymethyl- methacrylat	Polymethyl methacrylate	PMMA	40 - 110	Acryl, Plexiglas, Resartglas, Pegalan
			Polyoxymethylen	Polyoxymethylene	POM	24 - 110	Aceton, Hostaform, Latan, Delrin, Ultraform
			Polyamid	Polyamide (nylon)	PA	50 - 120	Ultramid, Akromid, Poly- loy, Nylon, Durethan
			Polyethylen- enterephthalat	Polyethylene terephthalate	PET	90 - 220	Hostaphan, Novatron
			Polybutylen- terephthalat	Polybutylene terephthalate	PBT	25 - 105	Enduran, Bitan,
			Polyphenylenether	Polyphenylene ether	PPE	55 - 68	Celanex
Polyaryletherketone	Polyaryletherketone	PEEK, PEK	92	Noryl, Vestoran			
	Duroplaste	Duroplastics	Polyimid	Polyimide	PI	75 - 100	Tecapeek, Ultrax
			Polyamidimid	Polyamide-imide	PAI	52 - 190	Sintimid, Kapton
			Polyetherimid	Polyetherimide	PEI	105 - 180	Torlon, Ensinger PAI
			Polymethacylimid	Polymethacylimide	PMI	88 - 98	Ultrern
			Phenol-Formaldehyd	Phenol-formaldehyde (resin)	PF	20 - 25	Rohacell
			Melamin- Formaldehyd	Melamine- formaldehyde (resin)	MF, MPF, UF	15 - 300	Delchi, Deltas, Resinol, Trolitan
			Ungesättigter Polyester	Unsaturated polyester	UP	25 - 40	Melmex, Urochem, Melopas, Duropal
			Epoxid	Epoxide	EP	25 - 80	Duro-lite, Ampal, Mitras, Tacon, Palatal
	Faser- verstärkte Kunststoffe	Aramid fiberglass	Aramidfaser (AFK)	Aramide fiber	AFK		Epikote, Eposite, Epodur, Araldit
			CFK, GFK	Carbon fiber, glass fiber	CFK, GFK		Rigitor, Nomex Durostone, Rigitor, Carbolan
	Verbund- werkstoffe	Composites	Honigwabenprofile, Hartpapier	honeycomb profiles Hard-paper			Pertinax, Resocel

Weitere Handelsnamen siehe Seite 358 More brand names see page 358

Auswahlübersicht Selection table

Schafffräser zur Aluminium- und Kunststoffbearbeitung End Mills for aluminium and plastic machining

<ul style="list-style-type: none"> ● sehr gut geeignet well suited ○ auch geeignet also suited 							
Typ Type							
K = kurz short L = lang long Ausführung Design							
Zähnezahl No. of teeth							
Drallwinkel Helix angle							
Schneidstoff Cutting material							
Seite Page							
	Werkstoff- bezeichnung	Material	Material- bezeichnung	Material description	Kurzbez. Abbreviation DIN-No.	Zugfestigkeit Tensile strength (N/mm ²)	Handelsname Brand name
	Aluminium- legierungen, langspanend	Aluminium alloys, long chipping	Reinaluminium	Aluminium	3.3308		AL99, 9Mg0,5
			Knetlegierungen, weich	Malleable alloys	3.3535	~250	ALMg 3 F24
			Knetlegierungen, ausgehärtet	Hardened casting alloys	3.4365	- 550	ALZnMgCu1,5 F53
	Aluminium- legierungen, kurzspanend	Aluminium alloys, short chipping	Gusslegierungen bis 12% Si	Casting alloys with < 12% Si	3.3292	- 450	GD-ALMg 9
			Gusslegierungen über 12% Si	Casting alloys with > 12% Si	3.2582	- 550	GD-ALSI12
	Elastomere, Schaum- stoffe	Elastomere, Foam	Kautschuk- Verbindungen	Rubber compounds	SBR, EPDM	4 - 25	Polysar, Buna SL, Buna EP
			Weichschaumstoffe	Soft foams	PUR	70 - 80	Ureol, Baydur
			Hartschaumstoffe	Hard foams	TSG, RSG		
	Thermo- plaste	Thermo- plastics	Acrylnitril- Butadien-Styrol	Acrylonitrile- butadiene-styrene	ABS	38 - 50	Lustran, Novodur, Terluran, Vestodur
			Polypropylen	Polypropylene	PP, PP-C	14 - 40	Hostalen, Novolen, Eltex, Vestolen
			Polyvinylchlorid	Polyvinyl chloride	PVC	10 - 20	Trovidur, Hostalit, Vestolit, Vinoflex, Vinnol
			Polyethylen	Polyethylene	PE, PE-HD, PE-LD	22 - 40	Baylon, Sustylen, Hosta- lem, Lumpolen, Vestolen
			Polycarbonat	Polycarbonate	PC	65 - 75	Bayfol, Makrolon, Stapron, Lexan, Merlon
			Polystyrol	Polystyrene	PS	30 - 60	Bucara, Langolen, Hostyren, Polystyrol
			Acrylnitril/ Styrol/Acrylester	Acrylonitrile- styrene-acrylate	ASA	45 - 65	Polyman, Luran s
			Polymethyl- methacrylat	Polymethyl methacrylate	PMMA	40 - 110	Acryl, Plexiglas, Resartglas, Pegalan
			Polyoxymethylen	Polyoxymethylene	POM	24 -110	Aceton, Hostaform, Latan, Delrin, Ultraform
			Polyamid	Polyamide (nylon)	PA	50 - 120	Ultramid, Akromid, Poly- loy, Nylon, Durethan
			Polyethylen- enterephthalat	Polyethylene terephthalate	PET	90 - 220 25 - 105	Hostaphan, Novatron Enduran, Bitan,
			Polybutylen- terephthalat	Polybutylene terephthalate	PBT		Celanex
Polyphenylenether	Polyphenylene ether	PPE	55 - 68	Noryl, Vestoran			
Polyaryletherketone	Polyaryletherketone	PEEK, PEK	92	Tecapeek, Ultrax			
	Duroplaste	Duroplastics	Polyimid	Polyimide	PI	75 - 100	Sintimid, Kapton
			Polyamidimid	Polyamide-imide	PAI	52 -190	Torlon, Ensinger PAI
			Polyetherimid	Polyetherimide	PEI	105 - 180	Ultern
			Polymethacylimid	Polymethacylimide	PMI	88 - 98	Rohacell
			Phenol-Formaldehyd	Phenol-formaldehyde (resin)	PF	20 - 25	Delchi, Deltas, Resinol, Trolitan
			Melamin- Formaldehyd	Melamine- formaldehyde (resin)	MF, MPF, UF	15 - 300	Melmex, Urochem, Melopas, Duropal
			Ungesättigter Polyester	Unsaturated polyester	UP	25 - 40	Durolite, Ampal, Mitras, Tacon, Palatal
Epoxid	Epoxide	EP	25 - 80	Epikote, Eposite, Epodur, Araldit			
	Faser- verstärkte Kunststoffe	Aramid fiberglass	Aramidfaser (AFK)	Aramide fiber	AFK		Rigitor, Nomex
			CFK, GFK	Carbon fiber, glass fiber	CFK, GFK		Durostone, Rigitor, Carbolan
	Verbund- werkstoffe	Composites	Honigwabenprofile, Hartpapier	honeycomb profiles Hard-paper			Pertinax, Resocel

Weitere Handelsnamen siehe Seite 358 More brand names see page 358

Typenbeschreibung Type description

AIRline und Schafffräser zur Aluminium- und Kunststoffbearbeitung AIRline and End Mills for aluminium and plastic machining

		DIN (WN = Werk- norm Fette Standard)	HM-Sorte Carbide Grade	Drallwinkel Helix angle λ	Schaft Shank DIN	Kat.-Nr. Cat.-No. unbeschichtet uncoated	Seite Page
	AIRline Schafffräser Schlicht , für Aluminium/Thermoplaste AIRline End Mills for finishing , for aluminium and thermoplastics	6527A	LW630	20°	6535HA	1571	338
	wahlweise mit innerer Kühlmittelzufuhr also with internal coolant supply	6527		30° IK	6535HB	1572	
	AIRline Schafffräser Schrapp , für Aluminium/Thermoplaste AIRline End Mills for roughing , for aluminium and thermoplastics	6527A	LW630	20°	6535HA	1586	339
	wahlweise mit innerer Kühlmittelzufuhr also with internal coolant supply	6527		30° IK	6535HB	1587	
	Schafffräser Einscheider, kurz und lang , Rechts- und Linksdrall, für Al-Bleche/-Pakete End Mills, Single Flute, short and long , R.H. Spiral/L.H. Spiral, for aluminium sheets and package	WN	LW630	20°	6535HA	1482	340
	Schafffräser, Zweischneider, lang mit Eckenwinkel 45° für Al-Bleche/Aluminium End Mills, 2-Flutes, long with corner angle 45° for aluminium sheets and packages	WN	LW630	25°	6535HA	176	344
	Schafffräser, Zweischneider, lang für Al-Bleche/Aluminium, mit Eckenradius End Mills, 2-Flutes, long for aluminium sheets and packages, with corner radius	WN	LW630	40°	6535HA	177	344
	Oberfräser/Einscheider, kurz und lang , Rechts- und Linksdrall, für harte Kunststoffe Router, single Flute, short and long , R.H. Spiral/L.H. Spiral, for hard plastics	WN	LW630	20°	6535HA	1496	345
	Oberfräser, Zweischneider , Rechts- und Linksdrall, für Acryl und harte Kunststoffe Router, 2-Flutes R.H. Spiral/L.H. Spiral for acrylic and hard plastics	WN	LW630	10°	6535HA	1491	346
	Oberfräser, Dreischneider , Rechts- und Linksdrall, für Acryl und harte Kunststoffe Router, 3-Flutes R.H. Spiral/L.H. Spiral for acrylic and hard plastics	WN	LW630	15°	6535HA	102	346
	Schafffräser, Zweischneider , mit Eckenradius, für harte und weiche Kunststoffe End Mills, 2-Flutes , with corner radius for hard and soft plastics	WN	LW630	30°	6535HA	1472	349
	Oberfräser, Einscheider , für weiche Kunststoffe Router, Single Flute , for soft plastics	WN	LW630	0°	6535HA	1495	347

Typenbeschreibung Type description

AIRline und Schafffräser zur Aluminium- und Kunststoffbearbeitung AIRline and End Mills for aluminium and plastic machining

		DIN (WN = Werk- norm Fette Standard)	HM-Sorte Carbide Grade	Drallwinkel Helix angle λ	Schaft Shank DIN	Kat.-Nr. Cat.-No. unbeschichtet uncoated	Seite Page
	Oberfräser, Einschneider Rechts- und Linksdrall, für weiche Kunststoffe Router, Single Flute R.H. and L.H. cutting, for soft plastics	WN	LW630	20°	6535HA	1497	347
	Oberfräser, Zweischneider für weiche Kunststoffe Router, 2-Flutes for soft plastics	WN	LW630	0°	6535HA	1492	348
	Schafffräser, Zweischneider für harte Kunststoffe End Mills, 2-Flutes for hard plastics	WN	LW630	0°	6535HA	1479	348
	Schafffräser, lang für Verbundwerkstoffe + GfK-Werkstoffe End Mills, long for composites	WN	LW630	–	6535HA	1473	350
	Profilfräser, Zweischneider zum Abrunden von Kunststoffen End Mills, 2-Flutes for edge rounding of plastics	WN	LW630	0°	6535HA	1499	351
	Profilfräser, Zweischneider zum Fasen von Kunststoffen End Mills for Profiling, 2-Flutes for chamfering	WN	LW630	0°	6535HA	1471	351
	HM-bestückte Sägeblätter für weiche und harte Kunststoffe Carbide Tipped Slitting Saws for soft and hard plastics	WN	LW630	0°	WN	1486	356
	Spannschaft (Aufnahme), für Kat.-Nr. 1486 Clamping shaft (tool holder), For Cat.-No. 1486	WN	–	–	WN	1487	356
	Sägeblätter mit VHM-Schneiden Rechts- und Linksschneidend, für weiche und harte Kunststoffe Solid Carbide Tipped Slitting Saws R.H. and L.H. cutting, for soft and hard plastics	WN	LW630	–	WN	1488	355
	HM-bestückte Sägeblätter Rechts- und Linksschneidend, für weiche und harte Kunststoffe Carbide Tipped Slitting Saws R.H. and L.H. cutting, for soft and hard plastics	WN	LW630	–	WN	1489	355

Vollhartmetall, Feinstkornsorte
stirnseitig bis Mitte schneidend
hinterschliffen
NC-gerecht

Solid Carbide
Super-fine grain type
center cutting
relief ground
suitable for NC

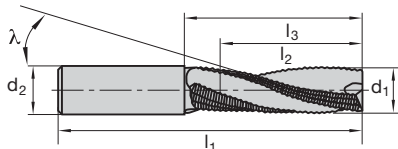

Katalog-Nr.	Cat.-No.	1571	1572	1586	1587
Bevorzugte Anwendung	Primary application	Aluminium/Thermoplaste		Aluminium/Thermoplastics	
Typ	Type	SH		SHR	
Norm	Standard	DIN 6527 A/B		DIN 6528	
Drallwinkel	Helix angle	$\lambda = 20^\circ$			
Zylinderschaft	Straight shank				
		DIN 6535 HA	DIN 6535 HB	DIN 6535 HA	DIN 6535 HB
Schneidstoffsorten ¹⁾	Cutting materials ¹⁾	LW630			

d ₁ h 12	l ₂	l ₁	l ₃	d ₂ h 6	z	Ident No.	Ident No.	Ident No.	Ident No.
4	11	57	21	6	2	1121971	1121975	-	-
5	13	57	21	6	2	1121972	1121976	-	-
6	13	57	21	6	2	1121973	1121977	1121980	1121982
8	19	63	27	8	2	1121909	1121918	1121895	1121902
10	22	72	32	10	2	1121910	1121919	1121896	1121903
12	26	83	38	12	3	1121911	1121920	1121897	1121904
14	26	83	38	14	3	1121912	1121921	1121898	1121915
16	32	92	44	16	3	1121913	1121922	1121899	1121906
18	32	92	44	18	3	1121916	1121924	1121900	1121907
20	38	104	54	20	3	1121917	1121925	1121901	1121908
25	45	121	65	25	3	1121974	1121979	1121981	1121983

¹⁾ Sortenbeschreibung siehe Seite 359
¹⁾ Description of grades see page 359

Schnittwertempfehlungen ab Seite 357
Cutting data recommendations starting page 357

Innere Kühlmittelzufuhr
Internal coolant supply

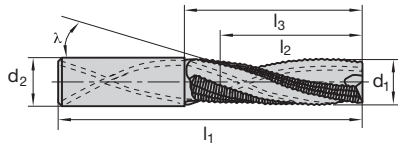

Katalog-Nr.	Cat.-No.	1571	1572	1586	1587				
Bevorzugte Anwendung	Primary application	Aluminium/Thermoplaste Aluminium/Thermoplastics							
Typ	Type	SH		SHR					
Norm	Standard	DIN 6527 A	DIN 6527 B	DIN 6527 A	DIN 6527 B				
Drallwinkel	Helix angle	λ = 30° Rechtsdrall							
Zylinderschaft	Straight shank								
Beschichtung	Coating	-							
Schneidstoffsorten ¹⁾	Cutting materials ¹⁾	LW630							
d ₁	l ₂	l ₁	l ₃	d ₂	z	Ident No.	Ident No.	Ident No.	Ident No.
8	19	63	27	8	2	1110000	1110005	1110011	1110017
10	22	72	32	10	2	1110001	1110006	1110012	1110018
12	26	83	38	12	3	1110002	1110008	1110013	1110019
16	32	92	44	16	3	1110003	1110009	1110014	1110020
20	38	104	54	20	3	1110004	1110010	1110015	1110021

¹⁾ Sortenbeschreibung siehe Seite 359
¹⁾ Description of grades see page 359

Schnittwertempfehlungen ab Seite 357
 Cutting data recommendations starting page 357

**Vollhartmetall
stirnseitig bis Mitte schneidend**

**Solide carbide
center cutting**

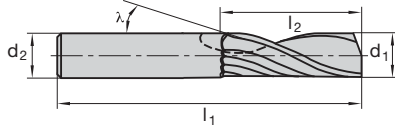

Katalog-Nr.	Cat.-No.	1482
Bevorzugte Anwendung	Primary application	AL-Bleche und -Pakete Aluminium sheet and packages
Norm	Standard	Werknorm Fette Standard
Drallwinkel	Helix angle	$\lambda = 20^\circ$ Rechtsdrall R. H. Spiral $\lambda = 20^\circ$ Linksdrall L. H. Spiral
Zylinderschaft	Straight shank	
Schneidstoffsorten ¹⁾	Cutting Materials ¹⁾	LW630

d ₁	l ₂	l ₁	d ₂ h 6	Ident No.	Ident No.
2	6	50	2	1501048	1501024
2	6	64	6	1501049	1501025
2,5	6	50	2,5	1501050	1501026
2,5	6	64	6	1501051	1501027
3	8	50	3	1501052	1501028
3	8	64	6	1501053	1501029
3	12	64	3	1501054	1501030
3	12	64	6	1501055	1501031
4	8	64	4	1501056	1501032
4	12	64	4	1501057	1501033
4	20	64	4	1501058	1501034
4	20	64	6	1501059	1501035
4	30	64	4	1501060	1501036
5	16	64	5	1501061	1501037
5	16	64	6	1501062	1501038
5	30	64	5	1501063	1501039
6	8	64	5	1501064	1501040
6	12	64	5	1501065	1501041
6	20	64	5	1501066	1501042
6	30	76	5	1501067	1501043
6	38	76	5	1501068	1501044
8	25	64	8	1501069	1501045
8	38	76	8	1501070	1501046
10	30	76	10	1501071	1501047

¹⁾ Sortenbeschreibung siehe Seite 359

¹⁾ Description of grades see page 359

Schnittwertempfehlungen ab Seite 357

Cutting data recommendations starting page 357

**Vollhartmetall
hinterschliffen
über Mitte schneidend**

**Solid Carbide
relief ground
centre cutting**

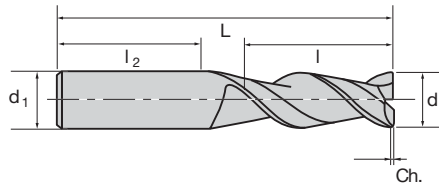

Katalog-Nr.	Cat.-No.	176
Typ	Type	N
Norm	Standard	Werksnorm
Drallwinkel	Helix angle	28°
Zylinderschaft	Straight shank	DIN 6535 HA
Beschichtung	Coating	auf Anfrage on request
Schneidstoffsorten ¹⁾	Cutting materials ¹⁾	

d₁	d₂	l₂	l₁	Winkel Angle 45°	Ident No.
2	6	6	50	0,1	176020
3	6	7	50	0,1	176030
4	6	8	50	0,1	176040
5	6	10	50	0,2	176050
6	6	10	50	0,2	176060
8	8	15	60	0,2	176080
10	10	18	65	0,25	176100
12	12	20	70	0,25	176120
14	14	22	75	0,25	176140
16	16	25	80	0,3	176160
18	18	28	100	0,3	176180
20	20	35	100	0,3	176200

**Vollhartmetall
hinterschliffen
über Mitte schneidend**

**Solid Carbide
relief ground
centre cutting**

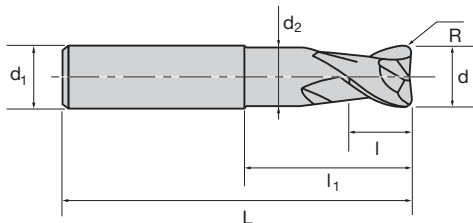

Katalog-Nr.	Cat.-No.	177
Typ	Type	N
Norm	Standard	Werksnorm
Drallwinkel	Helix angle	20°
Zylinderschaft	Straight shank	DIN 6535 HA
Beschichtung	Coating	auf Anfrage on request
Schneidstoffsorten ¹⁾	Cutting materials ¹⁾	

d ₁	d ₂ h 6	l ₂	l ₁	R	d ₃	Ident No.
-0,03-0,08						
6	6	7	57	1	5,5	177060
8	8	9	63	1	7,5	177080
10	10	11	72	1,5	9,5	177100
12	12	12	83	1,5	11,5	177120
14	14	14	85	1,5	13,5	177140
16	16	16	92	2	15,5	177160
20	20	20	104	2	19,5	177200
25	25	25	120	2,5	24	177250

Präzisionswerkzeug in Hartmetall, in polycrystallinem Diamant und in Bornitrid
Precision tools in hard metal, diamond polycrystalline and cubic boron nitride

Schnittwertempfehlungen ab Seite 357
Cutting data recommendations starting page 357
¹⁾ Sortenbeschreibung siehe Seite 359
¹⁾ Description of grades see page 359

**Vollhartmetall
hinterschliffen
über Mitte schneidend**

**Solid Carbide
relief ground
centre cutting**

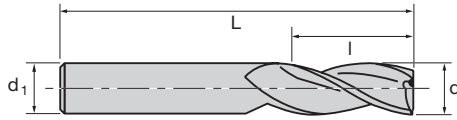

Katalog-Nr.	Cat.-No.	102
Typ	Type	N
Norm	Standard	Werksnorm
Drallwinkel	Helix angle	25°
Zylinderschaft	Straight shank	DIN 6535 HA
Beschichtung	Coating	auf Anfrage on request
Schneidstoffsorten ¹⁾	Cutting materials ¹⁾	

d ₁ -0,03 – 0,08	d ₂ h 6	l ₂	l ₁	Ident No.
2	2	7	40	102020
3	3	10	40	102030
4	4	11	48	102040
5	5	13	60	102050
6	6	16	60	102060
7	7	20	60	102070
8	8	23	60	102080
9	9	23	60	102090
10	10	23	60	102100
11	11	30	76	102110
12	12	30	76	102120
13	13	30	76	102130
14	14	30	76	102140
15	15	30	76	102150
16	16	32	80	102160
18	18	32	80	102180
20	20	38	90	102200

**Vollhartmetall
stirnseitig bis Mitte
schneidend**

**Solid Carbide
center cutting**

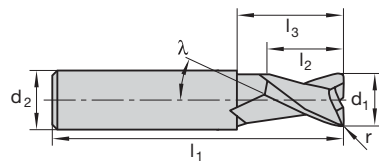

Katalog-Nr.	Cat.-No.	1485	1484
Bevorzugte Anwendung	Primary application	AL-Bleche/Aluminium Aluminium sheets/Aluminium	
Norm	Standard	Werknorm Fette Standard	
Drallwinkel	Helix angle	$\lambda = 25^\circ$ Rechtsdrall R. H. Spiral	$\lambda = 40^\circ$ Rechtsdrall R. H. Spiral
Zylinderschaft	Straight shank		
Schneidstoffsorten ¹⁾	Cutting Materials ¹⁾	LW630	

d ₁	l ₂	l ₁	l ₃	d ₂ h 6	r	Ident No.	Ident No.
4	6	64	14	4	0,5	1501088	-
6	10	64	25	6	0,5	1501089	-
8	12	76	30	8	0,5	1501091	-
10	14	76	35	10	0,5	1501092	-
12	16	88	38	12	0,5	1501093	-
6	10	64	28	6	-	-	1501286
8	10	64	28	8	-	-	1501287
10	12	64	24	10	-	-	1501288
12	19	76	31	12	-	-	1501289
16	19	89	41	16	-	-	1501290
20	25	102	52	20	-	-	1501291

¹⁾ Sortenbeschreibung siehe Seite 359

¹⁾ Description of grades see page 359

Schnittwertempfehlungen ab Seite 357

Cutting data recommendations starting page 357

Vollhartmetall
Solide Carbide

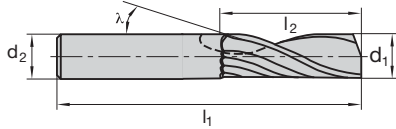

Katalog-Nr.	Cat.-No.	1496
Bevorzugte Anwendung	Primary application	Harte Kunststoffe hard plastics
Norm	Standard	Werknorm Fette Standard
Drallwinkel	Helix angle	$\lambda = 20^\circ$ Linksdrahl L. H. Spiral $\lambda = 20^\circ$ Rechtsdrahl R. H. Spiral
Zylinderschaft	Straight shank	
Besonderheiten	Special features	polierte Spannuten polished flutes
Schneidstoffsorten ¹⁾	Cutting materials ¹⁾	LW630

d ₁	l ₂	l ₁	d ₂ h 6	Ident No.	Ident No.
2	8	50	2	1501182	1501206
2	8	64	6	1501183	1501207
2,5	8	50	2,5	1501184	1501208
2,5	8	64	6	1501185	1501209
3	8	50	3	1501186	1501210
3	8	64	6	1501187	1501211
3	12	64	3	1501188	1501212
3	12	64	6	1501189	1501213
4	8	64	4	1501190	1501214
4	12	64	4	1501191	1501215
4	20	64	4	1501192	1501216
4	20	64	6	1501193	1501217
4	30	64	4	1501194	1501218
5	16	64	5	1501195	1501219
5	16	64	6	1501196	1501220
5	30	64	5	1501197	1501221
6	8	64	6	1501198	1501222
6	12	64	6	1501199	1501223
6	20	46	6	1501200	1501224
6	30	76	6	1501201	1501225
6	38	76	6	1501202	1501226
8	25	64	8	1501203	1501227
8	38	76	8	1501204	1501228
10	30	76	10	1501205	1501229

¹⁾ Sortenbeschreibung siehe Seite 359
¹⁾ Description of grades see page 359

Schnittwertempfehlungen ab Seite 357
 Cutting data recommendations starting page 357

Vollhartmetall
stirnseitig bis Mitte schneidend
NC-gerecht

Solid carbide
center cutting
suitable for NC

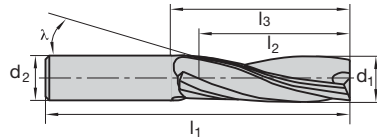

Katalog-Nr.	Cat.-No.	1491		1494	
Bevorzugte Anwendung	Primary application	Acryl und harte Kunststoffe Acrylic and hard plastics			
Norm	Standard	Werknorm Fette Standard			
Drallwinkel	Helix angle	$\lambda = 10^\circ$ Linksdrall L. H. Spiral	$\lambda = 10^\circ$ Rechtsdrall R. H. Spiral	$\lambda = 10^\circ$ Linksdrall L. H. Spiral	$\lambda = 10^\circ$ Rechtsdrall R. H. Spiral
Zylinderschaft	Straight shank				
Schneidstoffsorten ¹⁾	Cutting Materials ¹⁾	LW630			

d_1	l_2	l_1	$d_2 \text{ h } 6$	z	Ident No.	Ident No.	z	Ident No.	Ident No.
6	25	64	6	2	1501141	1501143	-	-	-
6	25	76	6	-	-	-	3	1501169	1501162
8	25	76	8	2	1501142	1501144	3	1501171	1501164
10	25	76	10	2	1501294	1501292	-	-	-
10	35	76	10	-	-	-	3	1501171	1501164
12	35	88	12	2	1501295	1501293	3	1501172	1501165
14	45	110	14	-	-	-	3	1501173	1501166
16	55	120	16	-	-	-	3	1501174	1501167
18	60	120	18	-	-	-	3	1501175	1501168

¹⁾ Sortenbeschreibung siehe Seite 359

¹⁾ Description of grades see page 359

Schnittwertempfehlungen ab Seite 357

Cutting data recommendations starting page 357

Vollhartmetall
Solide Carbide

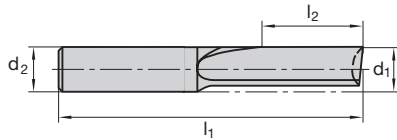

Katalog-Nr.	Cat.-No.	1495		1497		
Bevorzugte Anwendung	Primary application	Weiche Kunststoffe Soft plastic				
Norm	Standard	Werknorm Fette Standard				
Drallwinkel	Helix angle	$\lambda = 0^\circ$ geradegenutet straight flute	$\lambda = 20^\circ$ Rechtsdrall R. H. Spiral	$\lambda = 20^\circ$ Linksdrall L. H. Spiral		
Zylinderschaft	Straight shank					
Schneidstoffsorten ¹⁾	Cutting Materials ¹⁾	LW630				
d ₁	l ₂	l ₁	d ₂ h 6	Ident No.	Ident No.	Ident No.
4	16	64	6	1501176	-	-
5	20	64	6	1501177	-	-
6	25	64	6	1501178	-	-
8	25	76	8	1501179	-	-
10	35	88	10	1501180	-	-
12	35	88	12	1501181	-	-
2	8	50	2	-	1501254	1501230
2	8	64	6	-	1501255	1501231
2,5	8	50	2,5	-	1501256	1501232
2,5	8	64	6	-	1501257	1501233
3	8	50	3	-	1501258	1501234
3	8	64	6	-	1501259	1501235
3	12	64	3	-	1501260	1501236
3	12	64	6	-	1501261	1501237
4	8	64	4	-	1501262	1501238
4	12	64	4	-	1501263	1501239
4	20	64	4	-	1501264	1501240
4	20	64	6	-	1501265	1501241
4	30	64	4	-	1501266	1501242
5	16	64	5	-	1501267	1501243
5	16	64	6	-	1501268	1501244
5	30	64	5	-	1501269	1501245
6	8	64	6	-	1501270	1501246
6	12	64	6	-	1501271	1501247
6	20	64	6	-	1501272	1501248
6	30	76	6	-	1501273	1501249
6	38	76	6	-	1501274	1501250
8	25	64	8	-	1501275	1501251
8	38	76	8	-	1501276	1501252
10	30	76	10	-	1501277	1501253

¹⁾ Sortenbeschreibung siehe Seite 359
¹⁾ Description of grades see page 359

Schnittwertempfehlungen ab Seite 357
 Cutting data recommendations starting page 357

**Vollhartmetall
stirnseitig bis Mitte schneidend**

**Solid carbide
center cutting**

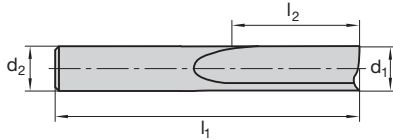

Katalog-Nr.	Cat.-No.	1492	1479
Bevorzugte Anwendung	Primary application	Weiche Kunststoffe Soft plastic	Harte Kunststoffe Hard plastic
Norm	Standard	Werknorm Fette Standard	
Drallwinkel	Helix angle	$\lambda = 0^\circ$ geradegenutet	
Zylinderschaft	Straight shank		
Schneidstoffsorten ¹⁾	Cutting Materials ¹⁾	LW630	

d_1	l_2	l_1	d_2 h 6	Ident No.	Ident No.
4	16	64	6	1501145	1501297
5	20	64	6	1501146	1501298
6	25	64	6	1501147	1501299
8	25	78	8	1501148	1501300
10	35	88	10	1501149	1501301
12	35	88	12	1501296	1501302

¹⁾ Sortenbeschreibung siehe Seite 359

¹⁾ Description of grades see page 359

Schnittwertempfehlungen ab Seite 357

Cutting data recommendations starting page 357

Vollhartmetall
stirnseitig bis Mitte schneidend

Solid carbide
center cutting

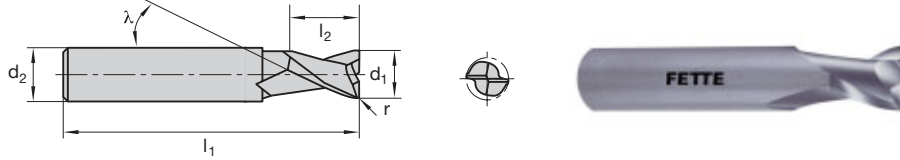

Katalog-Nr.	Cat.-No.	1472
Bevorzugte Anwendung	Primary application	Harte und weiche Kunststoffe Hard and soft plastics
Norm	Standard	Werknorm Fette Standard
Drallwinkel	Helix angle	$\lambda = 30^\circ$
Zylinderschaft	Straight shank	
Schneidstoffsorten ¹⁾	Cutting Materials ¹⁾	LW630

d₁	l₂	l₁	d₂ h 6	r	Ident No.
3	6	40	3	1	1501007
3	6	40	6	1	1501008
6	10	51	6	1,25	1501009
8	12	64	8	1,25	1501010
12	20	76	12	1,25	1501011

¹⁾ Sortenbeschreibung siehe Seite 359
¹⁾ Description of grades see page 359

Schnittwertempfehlungen ab Seite 357
 Cutting data recommendations starting page 357

**Vollhartmetall
stirnseitig bis Mitte schneidend**

**Solid carbide
center cutting**

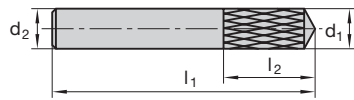

Katalog-Nr.	Cat.-No.	1473
Bevorzugte Anwendung	Primary application	Verbundwerkstoffe Composites
Norm	Standard	Werknorm Fette Standard
Drallwinkel	Helix angle	-
Zylinderschaft	Straight shank	
Schneidstoffsorten ¹⁾	Cutting Materials ¹⁾	LW630

d_1	l_2	l_1	$d_2 \text{ h } 6$	Ident No.
4	16	50	6	1501012
6	19	63	6	1501013
6	25	75	6	1501014
8	25	63	8	1501015
10	25	75	10	1501016
12	25	75	12	1501017

¹⁾ Sortenbeschreibung siehe Seite 359
¹⁾ Description of grades see page 359

Schnittwertempfehlungen ab Seite 357
Cutting data recommendations starting page 357

Vollhartmetall
stirnseitig bis Mitte schneidend

Solid carbide
center cutting

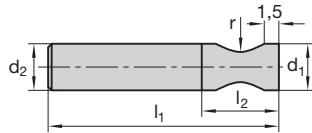

Katalog-Nr.	Cat.-No.	1499	1471
Bevorzugte Anwendung	Primary application	Abrunden von Kunststoffen Edge rounding	Fasen von Kunststoffen Chamfering
Norm	Standard	Werknorm Fette Standard	
Drallwinkel	Helix angle	$\lambda = 0^\circ$ geradegenutet	
Zylinderschaft	Straight shank		
Schneidstoffsorten ¹⁾	Cutting Materials ¹⁾	LW630	

d ₁	l ₂	l ₁	d ₂	r	Ident No.	Ident No.
6	5	70	10	-	-	1501001
6	6	70	10	-	-	1501003
6	8	70	10	-	-	1501005
8	5	76	12	-	-	1501002
8	6	76	12	-	-	1501004
8	8	76	12	-	-	1501006
6	10	64	6	3	1501303	-
6	10	64	6	4	1501284	-
6	10	64	6	5	1501304	-
6	10	64	6	6	1501285	-
8	12	64	8	8	1501305	-
10	14	70	10	10	1501306	-
12	16	76	12	12	1501307	-

¹⁾ Sortenbeschreibung siehe Seite 359
¹⁾ Description of grades see page 359

Schnittwertempfehlungen ab Seite 357
Cutting data recommendations starting page 357

gerade genutet
Rechtsschneidend
über Mitte schneidend

straight flute
right-hand cut
centre cutting

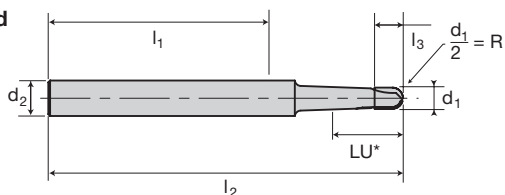

Katalog-Nr.		Cat.-No.					200	
d ₁	d ₂	l ₃	l ₂	l ₁	LU	z	Ident No.	
1	3	2	60	55	3	2	200 010	
2	4	4	60	52	6	2	200 020	
3	3	6	80	50	30	2	200 031	
3	6	6	80	70	10	2	200 030	
4	4	8	100	65	35	2	200 041	
4	6	8	80	65	12	2	200 040	
6	6	8	150	100	50	2	200 061	
6	10	8	100	70	15	2	200 060	
8	8	10	150	100	50	2	200 081	
8	10	10	100	60	20	2	200 080	
10	10	12	100	50	50	2	200 100	
10	10	12	165	95	70	2	200 101	
12	12	14	120	60	60	2	200 120	
12	12	14	165	85	80	2	200 121	
16	16	18	165	85	80	2	200 130	
20	20	20	165	85	80	2	200 200	

Standard Toleranzen General tolerances			
d ₁	d ₂	l ₃	l ₂
+0,02 -0,02	h6	+1 -0	+1 -0

Präzisionswerkzeug in Hartmetall, in polycrystallinem Diamant und in Bornitrid
Precision tools in hard metal, diamond polycrystalline and cubic boron nitride

Schnittwertempfehlungen ab Seite 357
Cutting data recommendations starting page 357

¹⁾ Sortenbeschreibung siehe Seite 359

¹⁾ Description of grades see page 359

gerade genutet
Rechtsschneidend

straight flute
right-hand cut

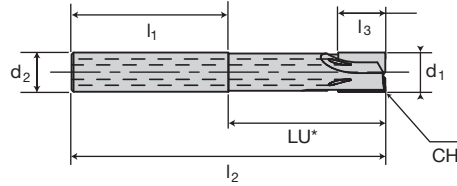

Katalog-Nr.		Cat.-No.							201	
d ₁	d ₂	l ₃	l ₂	l ₁	LU	z	CH 45°	Zentrale Kühlung Central coolant	Ident No.	
1	3	2	60	55	3	2	0,05		201 010	
2	4	4	60	52	6	2	0,05		201 020	
3	3	6	80	40	40	2	0,05		201 031	
3	6	6	80	70	10	2	0,05		201 030	
4	4	8	80	40	40	2	0,1		201 041	
4	8	8	80	68	12	2	0,1		201 040	
6	6	8	100	50	50	2	0,1		201 061	
6	10	8	80	40	15	2	0,1		201 060	
8	8	10	120	60	60	2	0,1	x	201 081	
8	10	10	80	40	20	2	0,1	x	201 080	
10	10	12	120	60	60	2	0,2	x	201 100	
12	12	14	120	60	60	2	0,2	x	201 120	
14	14	16	120	60	60	2	0,2	x	201 140	
16	16	18	140	70	70	2	0,2	x	201 160	
18	18	20	140	70	70	2	0,2	x	201 180	
20	20	22	160	80	80	2	0,2	x	201 200	

Standard Toleranzen General tolerances			
d ₁	d ₂	l ₃	l ₂
-0,03 -0,08	h6	+1 -0	+1 -0

Präzisionswerkzeug in Hartmetall, in polycrystallinem Diamant und in Bornitrid
Precision tools in hard metal, diamond polycrystalline and cubic boron nitride

Schnittwertempfehlungen ab Seite 357
Cutting data recommendations starting page 357

¹⁾ Sortenbeschreibung siehe Seite 359
¹⁾ Description of grades see page 359

Rechtsdrall
Rechtsschneidend

right-hand helix
right-hand cut

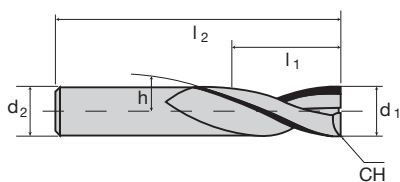

Katalog-Nr.		Cat.-No.					202
d ₁	d ₂	l ₁	l ₂	h	z	CH 45°	Ident No.
3	4	6,4	50	30°	2	0,05	202 030
4	4	9,5	76	30°	2	0,1	202 040
5	5	9,5	76	30°	2	0,1	202 050
6	6	9,5	76	30°	2	0,1	202 060
8	8	9,5	76	30°	2	0,1	202 080
10	10	12,7	89	30°	2	0,2	202 100
12	12	12,7	89	30°	2	0,2	202 120

Standard Toleranzen General tolerances			
d ₁	d ₂	l ₃	l ₂
-0,03 -0,08	h6	+1 -0	+1 -0

Präzisionswerkzeug in Hartmetall, in polycrystallinem Diamant und in Bornitrid
Precision tools in hard metal, diamond polycrystalline and cubic boron nitride

Schnittwertempfehlungen ab Seite 357
Cutting data recommendations starting page 357
1) Sortenbeschreibung siehe Seite 359
1) Description of grades see page 359

gelötete HM-Schneiden
brazed carbide tips

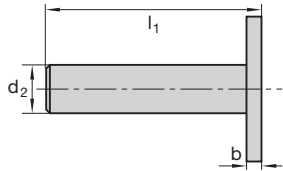

Katalog-Nr.	Cat.-No.	1488			1489			
Bevorzugte Anwendung	Primary application	Kunststoffe Plastics						
Norm	Standard	Werknorm Fette Standard						
Zylinderschaft	Straight shank	-						
Schneidstoffsorten ¹⁾	Cutting Materials ¹⁾	LW630						
Besonderheiten	Special features	Rechtsschneidend R. H. Cutting	Linksschneidend L. H. Cutting	Rechtsschneidend R. H. Cutting	Linksschneidend L. H. Cutting	Rechtsschneidend R. H. Cutting	Linksschneidend L. H. Cutting	
d₁	l₂	l₁	d₂	z	Ident No.	Ident No.	Ident No.	Ident No.
25,4	1,6	88	10	12	1501117	1501119	-	-
25,4	1,6	100	12	12	1501118	1501120	-	-
30,8	1,6	88	10	12	1501121	1501123	-	-
30,8	1,6	100	12	12	1501122	1501124	-	-
Weiche Kunststoffe Soft plastic								
50,8	2,4	100	12	10	-	-	1501125	1501126
50,8	2,4	100	12	16	-	-	1501127	1501128
Harte Kunststoffe Hard plastic								
50,8	2,4	100	12	10	-	-	1501129	1501130
50,8	2,4	100	12	16	-	-	1501131	1501132

¹⁾ Sortenbeschreibung siehe Seite 359
¹⁾ Description of grades see page 359

Schnittwertempfehlungen ab Seite 357
 Cutting data recommendations starting page 357

gelötete HM-Schneiden brazed carbide tips

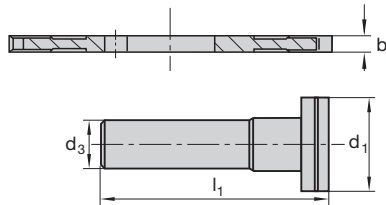

Katalog-Nr.	Cat.-No.	1486	1487
Bevorzugte Anwendung	Primary application	Kunststoffe Plastics	
Norm	Standard	Werknorm Fette Standard	
Zylinderschaft	Straight shank	-	
Schneidstoffsorten ¹⁾	Cutting Materials ¹⁾	LW630	-
Besonderheiten	Special features	Rechtsschneidend R. H. Cutting	Spannschaft Saw arbor

d ₁	l ₂	l ₁	d ₂	z	Ident No.	Ident No.
50,8	2,4	-	15,88	10	1501095	-
63,5	2,4	-	15,88	10	1501096	-
76,2	2,4	-	15,88	10	1501097	-
88,9	2,4	-	15,88	10	1501098	-
101,6	2,4	-	15,88	10	1501099	-
50,8	2,4	-	15,88	16	1501100	-
63,5	2,4	-	15,88	20	1501101	-
76,2	2,4	-	15,88	20	1501102	-
88,9	2,4	-	15,88	20	1501103	-
101,6	2,4	-	15,88	20	1501104	-
50,8	2,4	-	15,88	10	1501105	-
63,5	2,4	-	15,88	10	1501106	-
76,2	2,4	-	15,88	10	1501107	-
88,9	2,4	-	15,88	10	1501108	-
101,6	2,4	-	15,88	10	1501109	-
50,8	2,4	-	15,88	16	1501110	-
63,5	2,4	-	15,88	20	1501111	-
76,2	2,4	-	15,88	20	1501112	-
88,9	2,4	-	15,88	20	1501113	-
101,6	2,4	-	15,88	20	1501114	-
31,5	-	88	12	-	-	1501115
31,5	-	88	16	-	-	1501116

¹⁾ Sortenbeschreibung siehe Seite 359
¹⁾ Description of grades see page 359

Schnittwertempfehlungen ab Seite 357
Cutting data recommendations starting page 357

Technische Hinweise Technical hints

Schnittwertempfehlungen und Vorschübe für Schaft- und Oberfräser Cutting data recommendations and feeds for End Mills and Router

Werkstoff		Material		Schnittgeschwindigkeit Cutting speed v_c (m/min)	Vorschub pro Zahn Feed per tooth f_z für Fräser d_1 f_z at cutter diameter d_1			
					≤ 4 mm	5 - 10 mm	11 - 16 mm	> 16 mm
Aluminium	Knetlegierungen	Aluminium	Malleable alloys	900	0,05	0,1	0,15	0,25
	Gusslegierungen bis 12%		Casting alloys with < 12%	600	0,05	0,1	0,15	0,25
	Gusslegierungen über 12%		Casting alloys with > 12%	250	0,05	0,1	0,15	0,25
Weichplastik		Soft plastic		Drehzahl Speed n ≈ 20.000 min ⁻¹	0,10	0,15	0,20	0,3
Hartplastik		Hard plastic		Drehzahl Speed n ≈ 20.000 min ⁻¹	0,10	0,12	0,18	0,25
Verbundwerkstoffe		Composites		Drehzahl Speed n ≈ 20.000 min ⁻¹	0,03 ¹⁾	0,05 ¹⁾	0,06 ¹⁾	0,08 ¹⁾

¹⁾ Für Kat.-Nr. 1473 z = 10 For Cat. No. 1473 z = 10 (no. of teeth)

Schnittwertempfehlungen und Vorschübe für HM-Sägeblätter Cutting data recommendations and feeds for Carbide Slitting Saws

Werkstoff		Material		Schnittgeschwindigkeit Cutting speed v_c (m/min)	Vorschubgeschwindigkeit Feed rate v_f in mm/min	
					feine Teilung fine pitch	grobe Teilung coarse pitch
Aluminium	Knetlegierungen	Aluminium	Malleable alloys	900	≈ 4000 ²⁾	≈ 4000 ²⁾
	Gusslegierungen bis 12%		Casting alloys with < 12%	-	-	-
	Gusslegierungen über 12%		Casting alloys with > 12%	-	-	-
Weichplastik		Soft plastic		1500	≈ 4000	≈ 4000
Hartplastik		Hard plastic		1750	≈ 4000	≈ 4000
Verbundwerkstoffe		Composites		1750	≈ 4000	≈ 4000

²⁾ Für AL-Bleche bzw. Schnitttiefe bis max. 2 mm ²⁾ For Aluminium sheet or depth of cut to max. 2 mm

Berechnungsformeln

Calculation formulas

Drehzahl Speed

$$n = \frac{v_c \cdot 1000}{\pi \cdot d_1} \quad v_c = \text{Tab. Seite Page 357}$$

Vorschubgeschwindigkeit Feed rate

$$v_f = f_z \cdot z \cdot n \cdot f_1 \quad f_z = \text{Tab. Seite Page 357}$$

a_e = Schnittbreite in mm Width of cut in mm
 a_p = Schnitttiefe in mm Depth of cut in mm
 d_1 = Durchmesser in mm Cutter diameter in mm
 f_1 = Korrekturfaktor für v_f Correction factor v_f
 f_z = Vorschub pro Zahn in mm Feed per tooth in mm
 n = Drehzahl in min⁻¹ RPM in min⁻¹
 v_c = Schnittgeschwindigkeit in m/min Cutting speed in m/min
 v_f = Vorschubgeschwindigkeit in mm/min Feed rate in mm/min
 z = Anzahl der Schneiden No. of flutes

Vorschubkorrektur f_1

Feed rate correction factor f_1

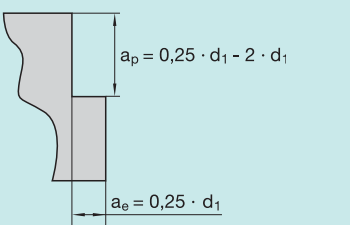
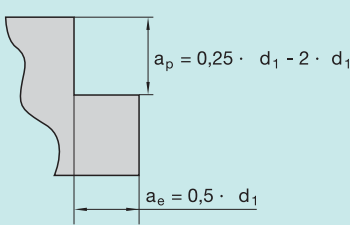
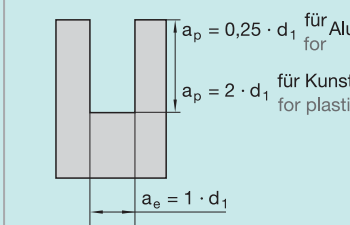
 <p>$a_p = 0,25 \cdot d_1 - 2 \cdot d_1$ $a_e = 0,25 \cdot d_1$ $f_1 = 1,0$</p>	 <p>$a_p = 0,25 \cdot d_1 - 2 \cdot d_1$ $a_e = 0,5 \cdot d_1$ $f_1 = 0,9$</p>	 <p>$a_p = 0,25 \cdot d_1$ für Aluminium für $a_p = 2 \cdot d_1$ für Kunststoffe für plastics $a_e = 1 \cdot d_1$ $f_1 = 0,75$</p>
---	--	--

Werkstoff	Material	Materialbez.	Material	Kurzbezeichnung Abbreviation DIN-No.	Zugfestigkeit Tensile strength (N/mm ²)	Handelsname Brand name
Aluminium- legierungen, langspanend	Aluminium alloys, long chipping	Reinaluminium	Aluminium	3.3308		AL99,9Mg0,5
		Knetlegierungen, weich	Malleable alloys	3.3535		ALMg 3 F24
		Knetlegierungen, ausgehärtet	Hardened casting alloys	3.4365	- 550	ALZnMgCu1,5 F53
Aluminium- legierungen, kurzspanend	Aluminium alloys, short chipping	Gusslegierungen bis 12% Si	Casting alloys with < 12% Si	3.3292	- 450	GD-ALMg 9
		Gusslegierungen über 12% Si	Casting alloys with > 12% Si	3.2582	- 550	GD-ALSi12
Elastomere, Schaumstoffe	Elastomere, Foam	Kautschuk- Verbindungen	Rubber compounds	SBR, EPDM	4 - 25	Polysar, Buna SL, Buna EP
		Weichschaumstoffe	Soft foams	PUR	70 - 80	Ureol, Baydur
		Hartschaumstoffe	Hard foams	TSG, RSG		
Thermoplaste	Thermoplastics	Acrylnitril-Butadien- Styrol	Acrylonitrile- butadiene-styrene	ABS	38 - 50	Lustran, Novodur, Terluran, Vestodur
		Polypropylen	Polypropylene	PP, PP-C	14 - 40	Hostalen, Novolen, Eltex, Vestolen
		Polyvinylchlorid	Polyvinyl chloride	PVC	8 - 20	Trovidur, Hostalit, Vestolit, Vinoflex, Vinnol
		Polyethylen	Polyethylene	PE, PE-HD, PE-LD	22 - 40	Baylon, Sustylen, Hostaleum, Lumpolen, Vestolen
		Polycarbonat	Polycarbonate	PC	65 - 75	Bayfol, Makrolon, Stapron, Lexan, Merlon
		Polystyrol	Polystyrene	PS	30 - 60	Bucara, Langolen, Hostyren, Polystyrol
		Acrylnitril/ Styrol/Acrylester	Acrylonitrile-styrene- acrylate	ASA	45 - 65	Polyman, Luran s
		Polymethyl- methacrylat	Polymethyl methacrylate	PMMA	40 - 110	Acryl, Plexiglas, Resartglas, Pegalan
		Polyoxymethylen	Polyoxymethylene	POM	24 - 110	Aceton, Hostaform, Latan, Delrin, Ultraform
		Polyamid	Polyamide (nylon)	PA	50 - 120	Ultramid, Akromid, Polyloy, Nylon, Durethan
		Polyethylen- enterephthalat	Polyethylene terephthalate	PET	90 - 220	Hostaphan, Novatron
		Polybutylen- terephthalat	Polybutylene terephthalate	PBT	25 - 105	Enduran, Bitan, Celanex
		Polyphenylenether Polyaryletherketone	Polyphenylene ether Polyaryletherketone	PPE PEEK, PEK	55 - 68 92	Noryl, Vestoran Tecapeek, Ultrax
Duroplaste	Duroplastics	Polyimid	Polyimide	PI	75 - 100	Sintimid, Kapton
		Polyamidimid	Polyamide-imide	PAI	52 - 190	Torlon, Ensinger PAI
		Polyetherimid	Polyetherimide	PEI	105 - 180	Ultern
		Polymethacylimid	Polymethacylimide	PMI	88 - 98	Rohacell
		Phenol- Formaldehyd	Phenol-formalde- hyde (resin)	PF	20 - 25	Delchi, Deltex, Resinol, Trolitan
		Melamin- Formaldehyd	Melamine-formalde- hyde (resin)	MF, MPF, UF	15 - 300	Melmex, Urochem, Melopas, Duropal
		Ungesättigter Polyester	Unsaturated polyester	UP	25 - 40	Durolite, Ampal, Mitras, Tacon, Palatal
		Epoxid	Epoxide	EP	25 - 80	Epikote, Eposite, Epodur, Araldit
Faserverstärkte Kunststoffe	Aramid fiberglass	Aramidfaser (AFK)	Aramide fiber	AFK		Rigitor, Nomex
		CFK, GFK	Carbon fiber, glass fiber	CFK, GFK		Durostone, Rigitor, Carbolan
Verbund- werkstoffe	Composites	Honigwabenprofile, Hartpapier	Hard-paper honeycomb profiles			Pertinax, Resocel

Technische Hinweise Technical hints

LMT-Schneidstoffe für Vollhartmetallfräser LMT cutting materials for Solid Carbide Endmills

	ISO-Hauptgruppe ISO Main group	Anwendungsgruppe Group of application	unbeschichtet uncoated	beschichtet coated	Cermet		
P	Stahl, Stahlguss, rostfreier Stahl, ferritisch und martensitisch Steel, cast steel, stainless steel, ferritic and martensitic	Zähigkeit ↑ Toughness Verschleißfestigkeit ↑ Wear resistance	01				
			10				
			20	LW 225	LC 630T	LC 620T	LC 620X
			30	LW 615			
			40	LW 630			
			50				
M	Rostfreier Stahl und Stahlguss, austenitisch und austenitisch/ferritisch Stainless steel and cast steel, austenitic and austenitic/ferritic	Zähigkeit ↑ Toughness Verschleißfestigkeit ↑ Wear resistance	10				
			20		LC 630T		
			30				
			40				
K	Grauguss, Sphäroguss, Temperguss Grey cast iron, cast iron with spheroidal graphite, malleable cast iron	Zähigkeit ↑ Toughness Verschleißfestigkeit ↑ Wear resistance	01				
			10	LW 615			
			20		LC 630T	LC 620T	
			30				
			40	LW 630			
N	Aluminium und andere Nichteisenmetalle, Kunststoffe Graphit Aluminium and other non ferrous metals plastics graphite	Zähigkeit ↑ Toughness Verschleißfestigkeit ↑ Wear resistance	01				
			10			LC 610A	
			20		LC 630T	LC 620T	
			30	LW 630			
			40				
S	Hochwarmfeste Stähle, Super- und Titanlegierungen High temperature alloys, super and titanium alloys	Zähigkeit ↑ Toughness Verschleißfestigkeit ↑ Wear resistance	10				
			20		LC 630T	LC 620T	
			30				
			40				
H	Gehärteter Stahl und Stahlguss Hardened steel and cast steel	Zähigkeit ↑ Toughness Verschleißfestigkeit ↑ Wear resistance	01				
			10				
			20		LC 620T	LC 620X	
			30				
			40				



Fräswerkzeuge PM-Edition, HSS

Milling Cutting Tools PM-Edition, HSS

PM-Edition-Schaftfräser PM-Edition End Mills	363
Schaftfräser HSS-E End Mills HSS-E	411
PM-Edition-Walzenstirnfräser PM-Edition Shell End Mills	469
Walzenstirnfräser HSS-E Shell End Mills HSS-E	481
Scheibenfräser HSS-E Side and Face Milling Cutters HSS-E	497
Metallkreissägeblätter Metal Slitting Saws	516
Formfräser HSS-E Form Milling Cutters HSS-E	533













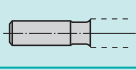
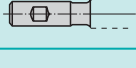



PM-Edition Schaftfräser

PM-Edition End Mills

Auswahlübersichten Selection tables	364, 365, 366
Typenbeschreibungen Type descriptions	367
Bohrnutenfräser Slot Drills	370
Schaft-Schlichtfräser Finishing End Mills	373
Schaft-Schrupfräser Roughing End Mills	393
Kopier-/Gesenschaftfräser Copying and Die-Sinking End Mills	395
Schnittwertempfehlungen Cutting data recommendations	408



Auswahlübersicht Selection table

Bohrnuten- und Schaft-Schlichtfräser Slot Drills and Finishing End Mills

			Seite Page							
Zylinderschaft DIN 1835 A Straight shank lang long		extra kurz stub length								
		kurz short	370	371	373	375	377	380		
Mit Mitnahmefläche DIN 1835 B Clamping flat lang long		extra kurz stub length								
		kurz short	370	371	373	375	377	380	379	
<ul style="list-style-type: none"> ● sehr gut geeignet well suited ○ auch geeignet also suited 										
										
Typ			N	N	N	SN	SN 50	H	SH	
≈ Drallwinkel Helix angle			30°	30°	30°	40°	50°	30°	20°	
Spanwinkel Rake angle			11°	11°	11°	16°	16°	7°	20°	
			Bohrnutenfräser Slot Drills			Schaft-Schlichtfräser Finishing End Mills				
			Tri-Cut							
z			2	3	4 und mehr 4 and more			2/3		
Werkstoff	Material	R_m/UTS (N/mm²)								
Unlegierter Baustahl	Plain carbon steel	- 700	●	●	●	●	●	○	○	
Automatenstahl	Free cutting steel	- 700	●	●	●	●	●	○		
Baustahl	Structural low alloy steel	500 - 950	●	●	●	●	●	○		
Vergütungsstahl, mittelfest	Heat-treatable steel, medium strength	500 - 950	●	●	●	●	●	○		
Stahlguss	Cast steel	- 950	●	●	●	●	●	○		
Einsatzstahl	Case hardening steel	- 950	●	●	●	●	●	○		
Rost- und säurebeständiger Stahl, ferritisch, martensitisch	Stainless steel, ferritic, martensitic	500 - 950	●	●	●	●	●	○	○	
Vergütungsstahl, hochfest	Heat-treatable steel, high strength	950 - 1400	○	○	○	○	○	●		
Nitrierstahl, vergütet	Nitriding steel	950 - 1400	○	○	○	○	○	●		
Werkzeugstahl (bis 45 HRC)	Tool steel (to 45 HRC)	950 - 1400	○	○	○	○	○	●		
Rost- und säurebeständiger Stahl, austenitisch	Stainless steel, austenitic	500 - 950	○	○	○	●	●	●		
Martensitaushärtbarer Stahl	Maraging steel									
Grauguss	Grey cast iron	100 - 400 (120 - 260 HB)	●	●	●	○	○	●		
Legierter Grauguss	Alloyed grey cast iron	150 - 250 (160 - 230 HB)	●	●	●	○	○	●		
Sphäroguss	Nodular cast iron	400 - 800 (120 - 310 HB)	●	●	●	○	○	○		
Temperguss	Malleable cast iron	350 - 700 (150 - 280 HB)	●	●	●	○	○	○		
Rein-Metalle, weich	Pure metals, soft	- 500	○	○	○	●	●	●	●	
Aluminium-Legierungen, langspanend	Aluminium alloys, long chipping	- 550	○	○	○	●	●	●	●	
Aluminium-Legierungen, kurzspanend	Aluminium alloys, short chipping	- 400	●	●	●	●	●	●	●	
Kupfer-Legierungen, langspanend	Copper alloys, long chipping	300 - 700	●	●	●	●	●	●	●	
Kupfer-Legierungen, kurzspanend	Copper alloys, short chipping	- 500	●	●	●	●	●	●	●	
Magnesium-Legierungen	Magnesium alloys	160 - 300	●	●	●	●	●	●	●	
Thermoplaste	Thermoplastics	40 - 70	○	○	○	●	●	●	●	
Duroplaste	Duroplastics	20 - 40	●	●	●	●	●	●	●	
Titanlegierungen, mittelfest	Titanium alloys, medium strength	- 950	○	○	○	●	●	●		
Titanlegierungen, hochfest	Titanium alloys, high strength	900 - 1400	○	○	○	●	●	●		
Nickelbasislegierungen, mittelfest	Nickel based alloys, medium strength	- 950	○	○	○	●	●	●		
Nickelbasislegierungen, hochwarmfest	Heat resistant nickel based alloys, high strength	900 - 1400	○	○	○	○	○	●		
Hartguss	Chilled cast iron	300 - 600	○	○	○	○	○	●		



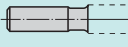

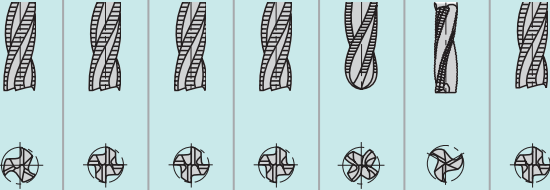



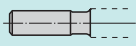
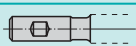

Auswahlübersicht Selection table

Schaft-Schruppfräser Roughing End Mills

			Seite Page							
Zylinderschaft DIN 1835 A Straight shank		extra kurz stub length		382			387			
		kurz short	381	383	385	388	391		393	
		lang long		384	386	389	392		394	
Mit Mitnahmefläche DIN 1835 B Clamping flat		extra kurz stub length		382			387			
		kurz short	381	383	385	388	391		393	
		lang long		384	386	389	392	390	394	
<ul style="list-style-type: none"> ● sehr gut geeignet well suited ○ auch geeignet also suited 										
Typ			NR	NR	NF	HR	HR	SHR	HF	
≈ Drallwinkel Helix angle			30°	30°	30°	30°	30°	20°	30°	
Spanwinkel Rake angle			11°	11°	11°	7°	7°	20°	7°	
z			3	4 und mehr 4 and more				2/3	4 und mehr 4 and more	
Werkstoff	Material	R _m /UTS (N/mm ²)								
Unlegierter Baustahl	Plain carbon steel	- 700	●	●	●	○	○	○	○	
Automatenstahl	Free cutting steel	- 700	●	●	●	○	○	○	○	
Baustahl	Structural low alloy steel	500 - 950	●	●	●	○	○	○	○	
Vergütungsstahl, mittelfest	Heat-treatable steel, medium strength	500 - 950	●	●	●	○	○	○	○	
Stahlguss	Cast steel	- 950	●	●	●	○	○	○	○	
Einsatzstahl	Case hardening steel	- 950	●	●	●	○	○	○	○	
Rost- und säurebeständiger Stahl, ferritisch, martensitisch	Stainless steel, ferritic, martensitic	500 - 950	●	●	●	○	○	○	○	
Vergütungsstahl, hochfest	Heat-treatable steel, high strength	950 - 1400	○	○	○	●	●	○	●	
Nitrierstahl, vergütet	Nitriding steel	950 - 1400	○	○	○	●	●	○	●	
Werkzeugstahl (bis 45 HRC)	Tool steel (to 45 HRC)	950 - 1400	○	○	○	●	●	○	●	
Rost- und säurebeständiger Stahl, austenitisch	Stainless steel, austenitic	500 - 950	●	●	●	●	●	○	●	
Martensitaushärtbarer Stahl	Maraging steel									
Grauguss	Grey cast iron	100 - 400 (120 - 260 HB)	●	●	●	●	●	○	●	
Legierter Grauguss	Alloyed grey cast iron	150 - 250 (160 - 230 HB)	●	●	●	●	●	○	●	
Sphäroguss	Nodular cast iron	400 - 800 (120 - 310 HB)	●	●	●	●	●	○	●	
Temperguss	Malleable cast iron	350 - 700 (150 - 280 HB)	●	●	●	●	●	○	●	
Rein-Metalle, weich	Pure metals, soft	- 500	●	●	●	●	●	●	●	
Aluminium-Legierungen, langspanend	Aluminium alloys, long chipping	- 550	●	●	●	●	●	●	●	
Aluminium-Legierungen, kurzspanend	Aluminium alloys, short chipping	- 400	●	●	●	●	●	●	●	
Kupfer-Legierungen, langspanend	Copper alloys, long chipping	300 - 700	●	●	●	●	●	●	●	
Kupfer-Legierungen, kurzspanend	Copper alloys, short chipping	- 500	●	●	●	●	●	●	●	
Magnesium-Legierungen	Magnesium alloys	160 - 300	●	●	●	●	●	●	●	
Thermoplaste	Thermoplastics	40 - 70	●	●	●	●	●	●	●	
Duroplaste	Duroplastics	20 - 40	●	●	●	●	●	●	●	
Titanlegierungen, mittelfest	Titanium alloys, medium strength	- 950	●	●	●	●	●	○	●	
Titanlegierungen, hochfest	Titanium alloys, high strength	900 - 1400	○	○	○	●	●	○	●	
Nickelbasislegierungen, mittelfest	Nickel based alloys, medium strength	- 950	○	○	○	●	●	○	●	
Nickelbasislegierungen, hochwarmfest	Heat resistant nickel based alloys, high strength	900 - 1400	○	○	○	●	●	○	●	
Hartguss	Chilled cast iron	300 - 600	○	○	○	●	●	○	●	

Auswahlübersicht Selection table







Kopierschaftfräser/Gesenkfräser Copying End Mills/Die-Sinking Cutters

			Seite Page					
Zylinderschaft DIN 1835 A Straight shank 	kurz short				398	402	405	
	lang long				399			
	extra lang stub x-long		397					
	WN Fette Standard							
	kurz short						400	
Mit Mitnahmefläche DIN 1835 B Clamping flat 	lang long						401	
	kurz short	395			398			
	lang long	396			399			
<ul style="list-style-type: none"> ● sehr gut geeignet well suited ○ auch geeignet also suited 								
								
Typ			N	N	H	H	H	WN
≈ Drallwinkel Helix angle			30°	30°	30°	30° konstant constant		30°
Spanwinkel Rake angle			11°	11°	7°	7°	7°	20°
			Radiusfräser Ball Nose End Mills		Gesenkfräser zylindrisch Cylindrical Die-Sinking Cutters	Schaftfräser kegelig End Mills, tapered		Radiusfräser Ball Nose End Mills
z			2	4	4 und mehr 4 and more	4		2
Werkstoff	Material	R_m/UTS (N/mm²)						
Unlegierter Baustahl	Plain carbon steel	- 700	●	●	○	○	○	
Automatenstahl	Free cutting steel	- 700	●	●	○	○	○	
Baustahl	Structural low alloy steel	500 - 950	●	●	○	○	○	
Vergütungsstahl, mittelfest	Heat-treatable steel, medium strength	500 - 950	●	●	○	○	○	
Stahlguss	Cast steel	- 950	●	●	○	○	○	
Einsatzstahl	Case hardening steel	- 950	●	●	○	○	○	
Rost- und säurebeständiger Stahl, ferritisch, martensitisch	Stainless steel, ferritic, martensitic	500 - 950	●	●	○	○	○	
Vergütungsstahl, hochfest	Heat-treatable steel, high strength	950 - 1400	○	○	●	●	●	
Nitrierstahl, vergütet	Nitriding steel	950 - 1400	○	○	●	●	●	
Werkzeugstahl (bis 45 HRC)	Tool steel (to 45 HRC)	950 - 1400	○	○	●	●	●	
Rost- und säurebeständiger Stahl, austenitisch	Stainless steel, austenitic	500 - 950	○	○				
Martensitaushärtbarer Stahl	Maraging steel							
Grauguss	Grey cast iron	100 - 400 (120 - 260 HB)	●	●	●	●	●	
Legierter Grauguss	Alloyed grey cast iron	150 - 250 (160 - 230 HB)	●	●	●	●	●	
Sphäroguss	Nodular cast iron	400 - 800 (120 - 310 HB)	●	●	●	●	●	
Temperguss	Malleable cast iron	350 - 700 (150 - 280 HB)	●	●	●	●	●	
Rein-Metalle, weich	Pure metals, soft	- 500	○	○	○			
Aluminium-Legierungen, langspanend	Aluminium alloys, long chipping	- 550	○	○	○			
Aluminium-Legierungen, kurzspanend	Aluminium alloys, short chipping	- 400	●	●	●	●	●	
Kupfer-Legierungen, langspanend	Copper alloys, long chipping	300 - 700	○	○	○			
Kupfer-Legierungen, kurzspanend	Copper alloys, short chipping	- 500	●	●	●	●	●	
Magnesium-Legierungen	Magnesium alloys	160 - 300	●	●	●	●	●	
Thermoplaste	Thermoplastics	40 - 70	○	○	○			○ ¹⁾
Duroplaste	Duroplastics	20 - 40	●	●	●	●	●	
Titanlegierungen, mittelfest	Titanium alloys, medium strength	- 950	●	●	●	●	●	
Titanlegierungen, hochfest	Titanium alloys, high strength	900 - 1400	○	○	●	●	●	
Nickelbasislegierungen, mittelfest	Nickel based alloys, medium strength	- 950	○	○	●	●	●	
Nickelbasislegierungen, hochwarmfest	Heat resistant nickel based alloys, high strength	900 - 1400	○	○	●	●	●	
Hartguss	Chilled cast iron	300 - 600	○	○	●	●	●	

¹⁾ Für Plastilin For Plastilin











Typenbeschreibung Type description

PM-Edition Schafffräser PM-Edition End Mills

	Schaft-Schlichtfräser Finishing End Mills	DIN	Kat.-Nr. Cat.-No.	TICN-Plus	Seite Page
Typ N 	Bohrnutenfräser Zweischneider Bohren auf volle Tiefe und anschließendes Längsfräsen; enge und formgenaue Passungen durch Rahmenfräsen. Drillwinkel $\approx 30^\circ$, Spanwinkel: 11° Slot Drills 2-flute For plunging to full depth and subsequent milling of accurate slots use cutters with Helix angle $\approx 30^\circ$, rake angle: 11°	327 B 327 D	F 405 F 445	F 405 C F 445 C	370
		327 B 327 D	F 406 F 416 kurz short	F 406 C F 416 C kurz short	371
Typ N 	Tri-Cut-Bohrnutenfräser Dreischneider Bohren auf volle Tiefe und anschließendes Längsfräsen; enge und formgenaue Passungen durch Rahmenfräsen. Drillwinkel $\approx 30^\circ$, Spanwinkel: 11° Tri-Cut Slot Drills 3-flute For plunging to full depth and subsequent milling of accurate slots use cutters with Helix angle $\approx 30^\circ$, rake angle: 11°	844 A 844 B	F 406 F 416 lang long	F 406 C F 416 C lang long	372
		844 A 844 B	F 500 F 501 kurz short	F 500 C F 501 C kurz short	373
Typ N 	Schaftfräser, grob gezahnt, Drillwinkel $\approx 30^\circ$, Spanwinkel: 11° Ein breites Anwendungsspektrum bei Werkstoffen geringer Festigkeit, bis hin zu schwer zerspanbaren Werkstoffen auch mit hoher Zähigkeit, z.B. Baustählen bis hin zu legierten Werkzeugstählen. Aber auch NE-Metalle sowie Kobalt- und Nickellegierungen. End Mills, coarse teeth, Helix angle $\approx 30^\circ$, rake angle: 11° Broad range of applications on materials with low strength, reaching over to materials that difficult to machine, having a high toughness, for example structural steels or alloyed tool steels. Also including non-ferrous metals, as well as cobalt- and nickel alloys.	844 A 844 B	F 500 F 501 kurz short	F 500 C F 501 C kurz short	373
		844 A 844 B	F 500 F 501 lang long	F 500 C F 501 C lang long	374
Typ SN 	Schaftfräser, Drillwinkel $\approx 40^\circ$, Spanwinkel: 16° Zum Schlichten mit hoher Zerspanungsleistung bei gleichzeitig guter Oberfläche von Stählen mit mittlerer bis hoher Festigkeit bis 1100 N/mm^2 (z. B. Bau-, Einsatz-, Vergütungsstähle); NE-Metalle, Rost- und säurebeständige Stähle. Bevorzugt Gleichlaufräsen. End Mills, Helix angle $\approx 40^\circ$, rake angle: 16° Finishing with high metal removal rates and good surface on steels with medium to high UTS up to 1100 N/mm^2 (for example for structural, case-hardening, heat-treatable steels); non-ferrous metals, stainless and acid resistant steels. Climb milling preferred.	$\approx 844 \text{ A}$ $\approx 844 \text{ B}$	F 503 F 523 kurz short	F 503 C F 523 C kurz short	375
		$\approx 844 \text{ A}$ $\approx 844 \text{ B}$	F 503 F 523 lang long	F 503 C F 523 C lang long	376
Typ SN 50 	Schaftfräser, hochgedrallt Hohe Konturgenauigkeit durch geringe Abdrängung, ruhiges Fräsverhalten durch geringe Vibrationsneigung, sehr gute Oberflächengüte in Ausführung: extra kurz, bis zu 30 % reduzierte Taktzeiten durch erhöhte Vorschubwerte. End Mills, high helix angle High degree of contour accuracy on account of low deflection, smooth milling operation because of low vibration in tendency, very good surface quality, in stub length design, up to 30 % reduced cycle times because of increased feed rates.	327 B 327 D	F 573 F 513 extra kurz stub length	F 573 C F 513 C extra kurz stub length	377
		327 B 327 D	F 573 F 513 kurz short	F 573 C F 513 C kurz short	376
Typ H 	Schaftfräser, feingezahnt $\approx 30^\circ$ Rechtsdrall, $\approx 7^\circ$ Spanwinkel für harte und kurzspanende Werkstoffe wie Grauguß, Messing, legierter Werkzeugstahl. End Mills, multi flute $\approx 30^\circ$ R. H. spiral, $\approx 7^\circ$ rake angle for tough and short chip producing materials, such as grey cast iron, brass, alloyed tool steel.	844 A 844 B	F 502 F 512 kurz short	F 502 C F 512 C kurz short	380
Typ SH 	AIR-Line Schafffräser Positive Span- und Freiwinkel bei sehr scharf ausgeschliffenen Schneiden sorgen für geringe Schnittkräfte und gute Oberflächen beim Schlichten. Bis zu 50% höhere Zerspanungsleistung bei fast allen Nichteisenmetallen und Kunststoffen. AIR-Line End Mills Positive cutting and clearance angles on very strongly internally ground cutting edges provide low cutting forces and good surfaces when finishing. Up to 50% higher chip removal rates on almost all non-ferrous metals and plastics.	844 B	F 524 lang long		379



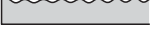







Typenbeschreibung Type description

PM-Edition Schafffräser PM-Edition End Mills

	Schaft-Schrupfräser Roughing End Mills	DIN	Kat.-Nr. Cat.-No.	TiCN-Plus	Seite Page	
Typ NR    	Tri-Cut-Schafffräser, Dreischneider, Drallwinkel ≈ 30°, Spanwinkel: 11° Schrapp-Kordelverzahnung Schrappfräsen von Werkstoffen bis mittlerer Festigkeit – vorwiegend langspanend, z. B. weiche Stähle, Al-Legierungen, Cu-Legierungen, Thermoplaste. Bevorzugt Gleichlaufräsen. Tri-Cut End Mills, 3-flute, Helix angle ≈ 30°, rake angle: 11° Knuckle type for roughing Roughing work on materials up to medium tensile strength – mainly long-chipping-producing, for example soft steels, Al-alloys, Cu-alloys, thermoplastics. Preferred climb milling.	≈ 844 A ≈ 844 B	F 427 F 467 kurz short	F 427 C F 467 C kurz short	381	
		327 B 327 D	F 506 F 516 extra kurz stub length	F 506 C F 516 C extra kurz stub length	382	
		844 A 844 B	F 506 F 516 kurz short	F 506 C F 516 C kurz short	383	
		Schafffräser, Drallwinkel ≈ 30°, Spanwinkel: 11° Schrapp-Kordelverzahnung Vorzugsweise für Werkstoffe bis mittlerer Festigkeit (≈ 1100 N/mm ²). Vorwiegend langspanend. F 506, F 506 C, F 516, F 516 C: Ruhiges Fräsverhalten durch geringe Vibrationsneigung, bis zu 30 % reduzierte Taktzeiten durch erhöhte Vorschubwerte. End Mills, Helix angle ≈ 30°, rake angle: 11° Knuckle type for roughing preferably for materials up to medium tensile strength (≈ 1100 N/mm ²). Mostly long-chip-producing. F 506, F 506 C, F 516, F 516 C: Smooth milling operation due to low tendency to vibration, up to 30 % reduced cycle times because of increased feed rates.	844 A 844 B	F 506 F 516 lang long	F 506 C F 516 C lang long	384
Typ NF  	Schafffräser Drallwinkel ≈ 30°, Spanwinkel: 11°, Schrapp-Schlichtverzahnung Großer Anwendungsbereich bei Werkstoffen mit mittlerer und hoher Festigkeit bis 1200 N/mm ² , z. B. Einsatz-, Vergütungsstähle, NE-Metalle sowie Gußeisen und Gußlegierungen. End Mills Helix angle ≈ 30°, rake angle: 11°, Truncated type for roughing Broad range of applications on materials of medium strength up to high tensile strength up to 1200 N/mm ² , for example case-hardening, heat-treatable steels, non-ferrous metals, also cast iron and alloy cast iron.	844 A 844 B	F 505 F 515 kurz short	F 505 C F 515 C kurz short	385	
		844 A 844 B	F 505 F 515 lang long	F 505 C F 515 C lang long	386	
Typ HR    	Schafffräser, feine Schrapp-Kordel-Verzahnung Großer Anwendungsbereich bei Werkstoffen mit mittlerer bis hoher Festigkeit (ca. 900-1400 N/mm ²), z. B. Einsatz-, Vergütungsstähle, Werkzeugstahl legiert, vergütet, NE-Metalle, hochwarmfeste Werkstoffe sowie Gußeisen und Gußlegierungen. Drallwinkel ≈ 30°, Spanwinkel: 7°	327 B 327 D	F 509 F 519 extra kurz stub length	F 509 C F 519 C extra kurz stub length	387	
		844 A 844 B	F 509 F 519 kurz short	F 509 C F 519 C kurz short	388	
		End Mills, fine tooth knuckle type for roughing Broad range of applications on materials of medium strength up to high tensile strength (~ 900-1400 N/mm ²), for example case-hardening, heat-treatable steels, alloy tool steel; hardened and tempered non-ferrous metals, high temperature materials, also cast iron and alloy cast iron. Helix angle ≈ 30°, rake angle: 7°	844 A 844 B	F 509 F 519 lang long	F 509 C F 519 C lang long	389
		Ausführung mit runder Stirn, stirnseitig bis Mitte schneidend.	1889/1BA 1889/1BB	F 576 F 586 kurz short	F 576 C F 586 C kurz short	391
		Ball nose, center cutting.	1889/1BA 1889/1BB	F 576 F 586 lang long	F 576 C F 586 C lang long	392
Typ SHR 	AIR-Line Schafffräser Hochpositiv ausgeschliffene Mikroschneiden und hoher Freiwinkel. Neu entwickeltes Schrappprofil speziell für Nichteisenmetalle und Kunststoffe. Stirn- und Umfangsschneiden für höchste Bohrvorschübe ausgelegt. Schräges Eintauchen möglich. AIR-Line End Mills Highly positive internally ground micro-cutters and high clearance angle. Newly developed roughing profile for non-ferrous metals and plastics. Centre and peripheral cutting edges designed for maximum drilling advance rate. Angled entry possible.	844B	F 525 lang long		390	

Typenbeschreibung Type description

PM-Edition Schafffräser PM-Edition End Mills

	Schaft-Schrupfräser Roughing End Mills	DIN	Kat.-Nr. Cat.-No.	TiCN-Plus	Seite Page
Typ HF  	Schaftfräser, Feine Schrupp-Schlichtverzahnung Großer Anwendungsbereich bei Werkstoffen mit mittlerer bis hoher Festigkeit (ca. 900-1400 N/mm ²), z. B. Einsatz-, Vergütungsstähle, Werkzeugstahl legiert, vergütet, NE-Metalle, hochwarmfeste Werkstoffe sowie Gußeisen und Gußlegierungen. Drallwinkel ≈ 30°, Spanwinkel: 7° End Mills, Fine tooth truncated type for roughing Broad range of applications on materials of medium strength up to high tensile strength (~ 900-1400 N/mm ²), for example case-hardening, heat-treatable steels, alloy tool steel; hardened and tempered non-ferrous metals, high temperature materials, also cast iron and alloy cast iron. Helix angle ≈ 30°, rake angle: 7°	844 A 844 B	F 507 F 517 kurz short	F 507 C F 517 C kurz short	393
		844 A 844 B	F 507 F 517 lang long	F 507 C F 517 C lang long	394
	Kopierschaft-/Gesenkfräser Copying End Mills and Die-Sinking Cutters	DIN (WN = Werknorm Fette Standard)	Kat.-Nr. Cat.-No.	TiCN-Plus	Seite Page
 	Radiusfräser, Zweischneider, stirnseitig bis Mitte schneidend Bohren auf volle Tiefe und anschließendes Längsfräsen; besonders geeignet zum Kopierfräsen. Großer Anwendungsbereich bei Werkstoffen mit mittlerer Festigkeit und Härte bis ca. 1200 N/mm ² , z. B. Einsatz- und Vergütungsstähle, NE-Metalle, GGG. Ball Nose End Mills, 2-flute, center cutting Slotting to full depth and subsequent milling; specially suited for copy milling. Broad range of applications on materials of medium strength and hardness up to 1200 N/mm ² . For example case-hardening, tempering steels, non-ferrous metals, nodular cast iron.	327 D	F 454 kurz short	F 454 C kurz short	395
		844 B	F 454 lang long	F 454 C lang long	396
 	Radiusfräser, Vierschneider (Kugelpkopier-Schaftfräser) stirnseitig bis Mitte schneidend. Mit kegelig verstärktem Übergang zwischen Schneidenteil und Zylinderschaft, variable Ausraglänge durch glatten Zylinderschaft nach DIN 1835 A. Ball Nose End Mills, 4-flute (Copying End Mills) center cutting With enlarged tapered run-out between cutting portion and shank, straight shank to DIN 1835 A.	WN	F 511 extra lang x-long	F 511 C extra lang x-long	397
Typ H  	Gesenkfräser, zylindrisch mit runder Stirn, bis Mitte schneidend, grobgezahnt, ≈ 30° Rechtsdrall, ≈ 7° Spanwinkel, für Werkstoffe hoher Festigkeit, über 900 N/mm ² , z. B. legierte Werkzeugstähle für den Formenbau. Cylindrical Die-Sinking Cutters, ball nose, center cutting, coarse tooth, ≈ 30° R. H. spiral, ≈ 7° rake angle; for materials of more than ≈ 900 N/mm ² strength, e. g. alloy tool steels for mold and pattern milling.	1889/1BA 1889/1BB	F 581 F 582 kurz short	F 581 C F 582 C kurz short	398
		1889/1BA 1889/1BB	F 581 F 582 lang long	F 581 C F 582 C lang long	399
Typ WN  	Radiusfräser Zweischneider, runde Stirn bis Mitte schneidend, Spanwinkel ≈ 20°, für Modell- u. Formenbau zum Fräsen von Plastilin, Hartschaum. Ball Nose End mills 2 flute, ball nose, center cutting, ≈ 20° rake angle; for the Model Making and Mould Making Industry for Milling of Plastilin, High-Resistance Foam.	WN		F 434 C kurz short	400
				F 434 C lang long	401
 gerade Stirn square end  runde Stirn ball nose	Schaftfräser, kegelig, für Formen- und Modellbau rechtsschneidend, 30° Rechtsdrall (konst.); 4 Schneiden, Zentrumschnitt, Schneideneigung von 1° bis 6° um 1° steigend, glatter Zylinderschaft nach DIN 1835 A. End Mills, tapered, for mold and pattern milling, R. H. cut, 30° helix angle (const.); 4-flute, center cutting, cutting edge taper from 1° to 6° with 1° rising, straight shank to DIN 1835 A.	WN	F 593	F 593 C	402
			F 594	F 594 C	405

stirnseitig bis Mitte schneidend
NC-gerecht

center cutting
suitable for NC

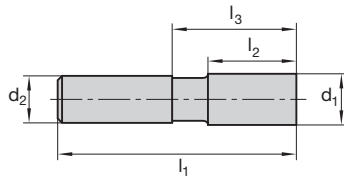

Katalog-Nr.	Cat.-No.	F 405	F 405 C	F 445	F 445 C
Typ	Type	N			
Norm	Standard	DIN 327 B		DIN 327 D	
Drallwinkel	Helix angle	≈ 30°			
Zylinderschaft	Straight shank	DIN 1835 A		DIN 1835 B	
Beschichtung	Coating	-	TiCN Plus	-	TiCN Plus
Werkstoff	Material	HSS-E-PM			

d ₁ e 8	l ₂	l ₁	l ₃	d ₂ h 6	Ident No.	Ident No.	Ident No.	Ident No.
4	7	51	15	6	1300406	1300419	1300430	1163534
5	8	52	16	6	1300407	1300420	1300431	1163558
6	8	52	16	6	1300408	1300421	1300432	1163555
7	10	60	20	10	1300410	1300422	1300433	1163556
8	11	61	21	10	1300411	1300423	1300434	1163559
10	13	63	23	10	1300412	1300424	1300435	1163561
12	16	73	28	12	1300413	1300425	1300437	1163563
14	16	73	28	12	1300414	1300426	1300438	1163564
16	19	79	31	16	1300415	1300427	1300439	1163565
18	19	79	31	16	1300416	1300428	1300440	1163560
20	22	88	38	20	1300417	1300429	1300441	1163567

stirnseitig bis Mitte schneidend
NC-gerecht

center cutting
 suitable for NC

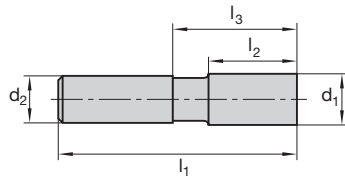

Katalog-Nr.	Cat.-No.	F 416	F 416 C	F 406	F 406 C
Typ	Type	N			
Norm	Standard	DIN 327 B		DIN 327 D	
Drallwinkel	Helix angle	≈ 30°			
Zylinderschaft	Straight shank	DIN 1835 A		DIN 1835 B	
Beschichtung	Coating	-	TiCN Plus	-	TiCN Plus
Werkstoff	Material	HSS-E-PM			

d ₁ e 8	l ₂	l ₁	l ₃	d ₂ h 6	Ident No.	Ident No.	Ident No.	Ident No.
4	7	51	15	6	1300241	1300264	1300217	1163636
5	8	52	16	6	1300242	1300265	1300218	1163638
6	8	52	16	6	1300243	1300266	1300219	1163639
7	10	60	20	10	1300244	1300268	1300220	1163640
8	11	61	21	10	1300245	1300269	1300222	1163641
10	13	63	23	10	1300246	1300270	1300223	1163643
12	16	73	28	12	1300247	1300271	1300224	1163645
14	16	73	28	12	1300248	1300272	1300225	1163648
16	19	79	31	16	1300249	1300273	1300226	1163647
18	19	79	31	16	1300250	1300274	1300227	1163650
20	22	88	38	20	1300251	1300275	1300228	1163649

Sonderausführungen und andere Beschichtungen auf Anfrage
 Special designs and other coatings on request

Schnittwertempfehlungen ab Seite 408
 Cutting data recommendations starting page 408

stirnseitig bis Mitte schneidend
NC-gerecht

center cutting
suitable for NC

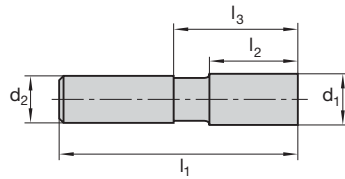

Katalog-Nr.	Cat.-No.	F 416	F 416 C	F 406	F 406 C
Typ	Type	N			
Norm	Standard	≈ DIN 844 A		≈ DIN 844 B	
Drallwinkel	Helix angle	≈ 30°			
Zylinderschaft	Straight shank	DIN 1835 A		DIN 1835 B	
Beschichtung	Coating	-	TiCN Plus	-	TiCN Plus
Werkstoff	Material	HSS-E-PM			

d ₁ e 8	l ₂	l ₁	l ₃	d ₂ h 6	Ident No.	Ident No.	Ident No.	Ident No.
4	11	55	19	6	1300252	1300277	1300229	1163606
5	13	57	21	6	1300253	1300278	1300231	1163679
6	13	57	21	6	1300254	1300279	1300232	1163687
7	16	66	26	10	1300255	1300280	1300233	1163688
8	19	69	28	10	1300256	1300281	1300234	1163689
10	22	72	31	10	1300257	1300282	1300235	1163693
12	26	83	38	12	1300259	1300283	1300236	1163695
14	26	83	38	12	1300260	1300284	1300237	1163696
16	32	92	44	16	1300261	1300286	1300238	1163697
18	32	92	44	16	1300262	1300287	1300239	1163698
20	38	104	54	20	1300263	1300288	1300240	1163699

stirnseitig bis Mitte schneidend
NC-gerecht

center cutting
 suitable for NC

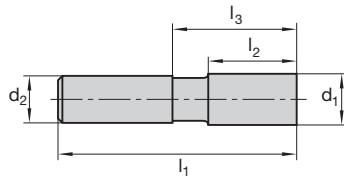

Katalog-Nr.	Cat.-No.	F 500	F 500 C	F 501	F 501 C
Typ	Type	N			
Norm	Standard	DIN 844 A		DIN 844 B	
Drallwinkel	Helix angle	≈ 30°			
Zylinderschaft	Straight shank	DIN 1835 A		DIN 1835 B	
Beschichtung	Coating	-	TiCN Plus	-	TiCN Plus
Werkstoff	Material	HSS-E-PM			

d ₁ k 10	l ₂	l ₁	l ₃	d ₂ h 6	z	Ident No.	Ident No.	Ident No.	Ident No.
5	13	57	21	6	4	1121074	1121006	1121138	1163746
6	13	57	21	6	4	1121075	1121007	1121139	1163748
7	16	66	26	10	4	1121076	1121008	1121140	1163775
8	19	69	28	10	4	1121077	1121009	1121141	1163750
10	22	72	31	10	4	1121078	1121010	1121142	1163752
12	26	83	38	12	4	1121079	1121011	1121143	1163754
14	26	83	38	12	4	1121080	1121012	1121144	1163777
16	32	92	44	16	4	1121081	1121013	1121145	1163756
18	32	92	44	16	4	1121082	1121014	1121146	1163779
20	38	104	54	20	4	1121083	1121015	1121147	1163758
22	38	104	54	20	5	1121084	1121016	1121148	1163781
25	45	121	65	25	5	1121085	1121017	1121149	1163760
28	45	121	65	25	5	1121086	1121018	1121150	1163783
30	45	121	65	25	5	1121087	1121019	1121151	1163764
32	53	133	73	32	6	1121088	1121020	1121152	1163766
36	53	133	73	32	6	1121089	1121121	1121153	1163768

Sonderausführungen und andere Beschichtungen auf Anfrage
 Special designs and other coatings on request

Schnittwertempfehlungen ab Seite 408
 Cutting data recommendations starting page 408



stirnseitig bis Mitte schneidend
NC-gerecht

center cutting
suitable for NC

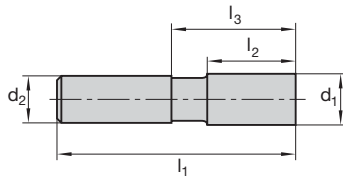

Katalog-Nr.	Cat.-No.	F 500	F 500 C	F 501	F 501 C
Typ	Type	N			
Norm	Standard	DIN 844 A		DIN 844 B	
Drallwinkel	Helix angle	≈ 30°			
Zylinderschaft	Straight shank	DIN 1835 A		DIN 1835 B	
Beschichtung	Coating	-	TiCN Plus	-	TiCN Plus
Werkstoff	Material	HSS-E-PM			

d ₁ k 10	l ₂	l ₁	l ₃	d ₂ h 6	z	Ident No.	Ident No.	Ident No.	Ident No.
4	19	63	27	6	4	1121090	1121122	1121154	1121170
5	24	68	32	6	4	1121091	1121123	1121155	1121171
6	24	68	32	6	4	1121092	1121124	1121156	1121172
7	30	80	40	10	4	1121093	1121125	1121157	1121173
8	38	88	47	10	4	1121094	1121126	1121158	1121174
10	45	95	57	10	4	1121095	1121127	1121159	1121175
12	53	110	65	12	4	1121096	1121128	1121160	1121176
14	53	110	65	12	4	1121097	1121129	1121161	1121177
16	63	123	75	16	4	1121098	1121130	1121162	1121178
18	63	123	75	16	4	1121099	1121131	1121163	1121179
20	75	141	91	20	4	1121100	1121132	1121164	1121180
22	75	141	91	20	5	1121101	1121133	1121165	1121181
25	90	166	110	25	5	1121102	1121134	1121166	1121182
28	90	166	110	25	5	1121103	1121135	1121167	1121183
30	90	166	110	25	5	1121004	1121136	1121168	1121184
32	106	186	126	32	6	1121005	1121137	1121169	1121185

Sonderausführungen und andere Beschichtungen auf Anfrage
Special designs and other coatings on request

Schnittwertempfehlungen ab Seite 408
Cutting data recommendations starting page 408

stirnseitig bis Mitte schneidend
NC-gerecht

center cutting
 suitable for NC

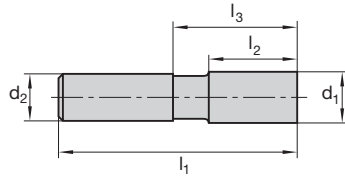

Katalog-Nr.	Cat.-No.	F 503	F 503 C	F 523	F 523 C
Typ	Type	SN			
Norm	Standard	≈ DIN 844 A		≈ DIN 844 B	
Drallwinkel	Helix angle	≈ 40°			
Zylinderschaft	Straight shank	DIN 1835 A		DIN 1835 B	
Beschichtung	Coating	-	TiCN Plus	-	TiCN Plus
Werkstoff	Material	HSS-E-PM			

d ₁ k 10	l ₂	l ₁	l ₃	d ₂ h 6	z	Ident No.	Ident No.	Ident No.	Ident No.
4	11	55	19	6	4	1121186	1121219	1121251	1136480
5	13	57	21	6	4	1121187	1121220	1121252	1135536
6	13	57	21	6	4	1121188	1121221	1121253	1136519
7	16	66	26	10	4	1121189	1121222	1121254	1135537
8	19	69	28	10	4	1121190	1121223	1121255	1136521
10	22	72	31	10	4	1121191	1121224	1121256	1136523
12	26	83	38	12	4	1121192	1121225	1121257	1136525
14	26	83	38	12	4	1121193	1121226	1121258	1135538
16	32	92	44	16	4	1121194	1121227	1121259	1136527
18	32	92	44	16	4	1121195	1121228	1121260	1135539
20	38	104	54	20	4	1121196	1121229	1121261	1136529
22	38	104	54	20	5	1121197	1121230	1121262	1135540
25	45	121	65	25	6	1121198	1121231	1121263	1136531
28	45	121	65	25	6	1121199	1121232	1121264	1135541
30	45	121	65	25	6	1121200	1121233	1121265	1136533
32	53	133	73	32	6	1121201	1121234	1121266	1136535

Sonderausführungen und andere Beschichtungen auf Anfrage
 Special designs and other coatings on request

Schnittwertempfehlungen ab Seite 408
 Cutting data recommendations starting page 408

stirnseitig bis Mitte schneidend
NC-gerecht

center cutting
suitable for NC

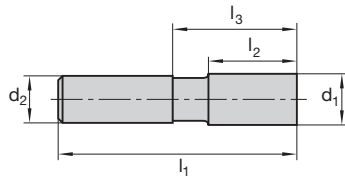

Katalog-Nr.	Cat.-No.	F 503	F 503 C	F 523	F 523 C
Typ	Type	SN			
Norm	Standard	≈ DIN 844 A		≈ DIN 844 B	
Drallwinkel	Helix angle	≈ 40°			
Zylinderschaft	Straight shank	DIN 1835 A		DIN 1835 B	
Beschichtung	Coating	-	TiCN Plus	-	TiCN Plus
Werkstoff	Material	HSS-E-PM			

d ₁ k 10	l ₂	l ₁	l ₃	d ₂ h 6	z	Ident No.	Ident No.	Ident No.	Ident No.
4	19	63	27	6	4	1121202	1121235	1121267	1163787
5	24	68	32	6	4	1121204	1121236	1121268	1163792
6	24	68	32	6	4	1121205	1121237	1121269	1163789
7	30	80	40	10	4	1121206	1121238	1121270	1163794
8	38	88	47	10	4	1121207	1121239	1121271	1163791
10	45	95	57	10	4	1121208	1121240	1121272	1163793
12	53	110	65	12	4	1121209	1121241	1121273	1163795
14	53	110	65	12	4	1121210	1121242	1121274	1163796
16	63	123	75	16	4	1121211	1121243	1121275	1163797
18	63	123	75	16	4	1121212	1121244	1121276	1163798
20	75	141	91	20	4	1121213	1121245	1121277	1163801
22	75	141	91	20	5	1121214	1121246	1121278	1163800
25	90	166	110	25	6	1121215	1121247	1121279	1163803
28	90	166	110	25	6	1121216	1121248	1121280	1163802
30	90	166	110	25	6	1121217	1121249	1121281	1163805
32	106	186	126	32	6	1121218	1121250	1121282	1163807

Sonderausführungen und andere Beschichtungen auf Anfrage
Special designs and other coatings on request

Schnittwertempfehlungen ab Seite 408
Cutting data recommendations starting page 408

stirnseitig bis Mitte schneidend
NC-gerecht

center cutting
 suitable for NC

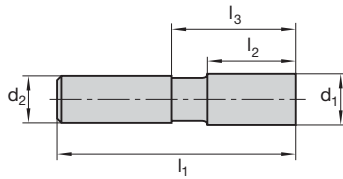

Katalog-Nr.	Cat.-No.	F 573	F 573 C	F 513	F 513 C
Typ	Type	SN 50			
Norm	Standard	DIN 327 B		DIN 327 D	
Drallwinkel	Helix angle	≈ 50°			
Zylinderschaft	Straight shank	DIN 1835 A		DIN 1835 B	
Beschichtung	Coating	-	TiCN Plus	-	TiCN Plus
Werkstoff	Material	HSS-E-PM			

d ₁ k 10	l ₂	l ₁	l ₃	d ₂ h 6	z	Ident No.	Ident No.	Ident No.	Ident No.
6	8	52	16	6	3	1121337	1121354	1121373	1136518
8	11	61	21	10	3	1121338	1121355	1121374	1136520
10	13	63	23	10	3	1121339	1121356	1121375	1136522
12	16	73	28	12	4	1121340	1121357	1121376	1136524
16	19	79	31	16	4	1121341	1121358	1121377	1136526
20	22	88	38	20	4	1121342	1121359	1121378	1136528
25	26	102	46	25	4	1121343	1121360	1121379	1136530
30	26	102	46	25	6	1121344	1121361	1121380	1136532
32	32	112	52	32	6	1121345	1121362	1121381	1136534

Sonderausführungen und andere Beschichtungen auf Anfrage
 Special designs and other coatings on request

Schnittwertempfehlungen ab Seite 408
 Cutting data recommendations starting page 408

stirnseitig bis Mitte schneidend
NC-gerecht

center cutting
suitable for NC

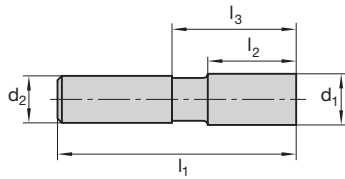

Katalog-Nr.	Cat.-No.	F 573	F 573 C	F 513	F 513 C
Typ	Type	SN 50			
Norm	Standard	≈ DIN 844 A		≈ DIN 844 B	
Drallwinkel	Helix angle	≈ 50°			
Zylinderschaft	Straight shank	DIN 1835 A		DIN 1835 B	
Beschichtung	Coating	-	TiCN Plus	-	TiCN Plus
Werkstoff	Material	HSS-E-PM			

d ₁ k 10	l ₂	l ₁	l ₃	d ₂ h 6	z	Ident No.	Ident No.	Ident No.	Ident No.
6	13	57	21	6	3	1121346	1121363	1121382	1121391
8	19	69	28	10	3	1121347	1121364	1121383	1121392
10	22	72	31	10	3	1121348	1121365	1121384	1121393
12	26	83	38	12	4	1121349	1121366	1121385	1121394
16	32	92	44	16	4	1121350	1121367	1121386	1121395
20	38	104	54	20	4	1121351	1121368	1121387	1121396
25	45	121	65	25	4	1121352	1121369	1121388	1121397
30	45	121	65	25	6	1121353	1121370	1121389	1121398
32	53	133	73	32	6	1121372	1121371	1121390	1121399

stirnseitig bis Mitte schneidend

NC-gerecht

PM-Schnellstahl

hinterschliffen

center cutting

suitable for NC

PM-high-speed steel

relief ground

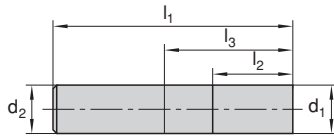

Katalog-Nr.	Cat.-No.	F 524
Bevorzugte Anwendung	Primary application	Aluminium/Thermoplaste Aluminium/Thermoplastics
Typ	Type	SH
Norm	Standard	DIN 844 B
Drallwinkel	Helix angle	20° Rechtsdrall 20° R. H. Spiral
Zylinderschaft	Straight shank	DIN 1835 B ¹⁾
Schneidstoff	Cutting material	HSS-E-PM

d ₁ k 10	l ₂	l ₃	l ₁	d ₂ h 6	z	Ident No.
8	38	47	88	10	2	1121942
10	45	57	95	10	2	1121943
12	53	65	110	12	3	1121944
14	53	65	110	12	3	1121945
16	63	75	123	16	3	1121946
18	63	75	123	16	3	1121947
20	75	91	141	20	3	1121948
25	90	110	166	25	3	1121949
30	90	110	166	25	3	1121951
32	106	126	186	32	3	1121952

¹⁾ Schaftausführung nach DIN 1835 A kurzfristig lieferbar.

¹⁾ Shank type to DIN 1835 A available at short notice.

Schnittwertempfehlungen ab Seite 408

Cutting data recommendations starting page 408

stirnseitig bis Mitte schneidend
NC-gerecht

center cutting
suitable for NC

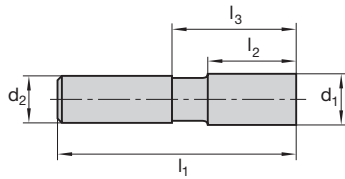

Katalog-Nr.	Cat.-No.	F 502	F 502 C	F 512	F 512 C
Typ	Type	H			
Norm	Standard	DIN 844 A		DIN 844 B	
Drallwinkel	Helix angle	≈ 30°			
Zylinderschaft	Straight shank	DIN 1835 A		DIN 1835 B	
Beschichtung	Coating	-	TiCN Plus	-	TiCN Plus
Werkstoff	Material	HSS-E-PM			

d ₁ k 10	l ₂	l ₁	l ₃	d ₂ h 6	z	Ident No.	Ident No.	Ident No.	Ident No.
6	13	57	21	6	6	1300448	1300442	1133450	1300453
8	19	69	28	10	6	1300449	1300443	1133452	1300455
10	22	72	31	10	6	1300450	1300444	1133454	1300456
12	26	83	38	12	6	1300451	1300446	1133456	1300457
16	32	92	44	16	6	1300452	1300447	1133458	1300458

stirnseitig bis Mitte schneidend
 NC-gerecht
 hinterschliffen

center cutting
 suitable for NC
 relief ground

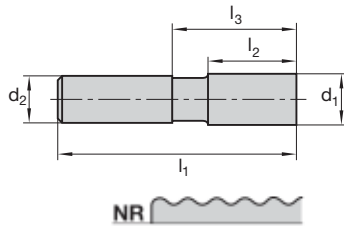

Katalog-Nr.	Cat.-No.	F 427	F 427 C	F 467	F 467 C
Typ	Type	NR			
Norm	Standard	≈ DIN 844 A		≈ DIN 844 B	
Drallwinkel	Helix angle	≈ 30°			
Zylinderschaft	Straight shank	DIN 1835 A		DIN 1835 B	
Beschichtung	Coating	-	TiCN Plus	-	TiCN Plus
Werkstoff	Material	HSS-E-PM			

d ₁ k 10	l ₂	l ₁	l ₃	d ₂ h 6	Ident No.	Ident No.	Ident No.	Ident No.
6	13	57	21	6	1300621	1300630	1300639	1163595
8	19	69	28	10	1300623	1300632	1300641	1163597
10	22	72	31	10	1300624	1300633	1300642	1163599
12	26	83	38	12	1300625	1300634	1300643	1163601
14	26	83	38	12	1300626	1300635	1300644	1300648
16	32	92	44	16	1300627	1300636	1300645	1163603
18	32	92	44	16	1300628	1300637	1300646	1300649
20	38	104	54	20	1300629	1300638	1300647	1163605

stirnseitig bis Mitte schneidend
NC-gerecht
hinterschliffen

center cutting
suitable for NC
relief ground

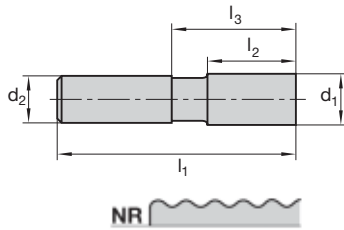

Katalog-Nr.	Cat.-No.	F 506	F 506 C	F 516	F 516 C
Typ	Type	NR			
Norm	Standard	DIN 327 B		DIN 327 D	
Drallwinkel	Helix angle	≈ 30°			
Zylinderschaft	Straight shank	DIN 1835 A		DIN 1835 B	
Beschichtung	Coating	-	TiCN Plus	-	TiCN Plus
Werkstoff	Material	HSS-E-PM			

d ₁ k 10	l ₂	l ₁	l ₃	d ₂ h 6	z	Ident No.	Ident No.	Ident No.	Ident No.
6	8	52	16	6	4	1120687	1120696	1120705	1163830
8	11	61	21	10	4	1120688	1120697	1120706	1163832
10	13	63	23	10	4	1120689	1120698	1120707	1163834
12	16	73	28	12	4	1120690	1120699	1120708	1163836
16	19	79	31	16	4	1120691	1120700	1120709	1163838
20	22	88	38	20	4	1120692	1120701	1120710	1163840
25	26	102	46	25	4	1120693	1120702	1120711	1163844
30	26	102	46	25	5	1120694	1120703	1120712	1163846
32	32	112	52	32	6	1120695	1120704	1120713	1163848

Sonderausführungen und andere Beschichtungen auf Anfrage
Special designs and other coatings on request

Schnittwertempfehlungen ab Seite 408
Cutting data recommendations starting page 408

stirnseitig bis Mitte schneidend
NC-gerecht
hinterschliffen

center cutting
 suitable for NC
 relief ground

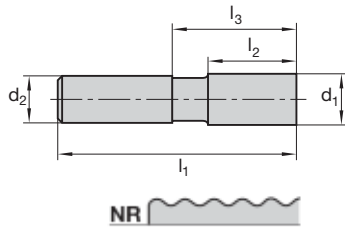

Katalog-Nr.	Cat.-No.	F 506	F 506 C	F 516	F 516 C
Typ	Type	NR			
Norm	Standard	DIN 844 A		DIN 844 B	
Drallwinkel	Helix angle	≈ 30°			
Zylinderschaft	Straight shank	DIN 1835 A		DIN 1835 B	
Beschichtung	Coating	-	TiCN Plus	-	TiCN Plus
Werkstoff	Material	HSS-E-PM			

d ₁ k 10	l ₂	l ₁	l ₃	d ₂ h 6	z	Ident No.	Ident No.	Ident No.	Ident No.
6	13	57	21	6	4	1300650	1300683	1163850	1163868
7	16	66	26	10	4	1300651	1300684	1120664	1120675
8	19	69	28	10	4	1300652	1300685	1163852	1163870
9	19	69	28	10	4	1300653	1300687	1120665	1120676
10	22	72	31	10	4	1300654	1300688	1163854	1163872
11	22	79	34	12	4	1300655	1300689	1120666	1120677
12	26	83	38	12	4	1300656	1300690	1163856	1163874
14	26	83	38	12	4	1300657	1300691	1120667	1120678
16	32	92	44	16	4	1300658	1300692	1163858	1163876
18	32	92	44	16	4	1300660	1300693	1120668	1120679
20	38	104	54	20	4	1300661	1300694	1163860	1163878
22	38	104	54	20	4	1300662	1300696	1120669	1120680
24	45	121	65	25	4	1300663	1300697	1120670	1120681
25	45	121	65	25	4	1300664	1300698	1163862	1163880
28	45	121	65	25	5	1300665	1300699	1120671	1120682
30	45	121	65	25	5	1300666	1300700	1163864	1163882
32	53	133	73	32	6	1300667	1120650	1163866	1163884
36	53	133	73	32	6	1300669	1120651	1120672	1120683
40	63	155	85	40	6	1300670	1120652	1300620	1120684

Sonderausführungen und andere Beschichtungen auf Anfrage
 Special designs and other coatings on request

Schnittwertempfehlungen ab Seite 408
 Cutting data recommendations starting page 408

stirnseitig bis Mitte schneidend
NC-gerecht
hinterschliffen

center cutting
suitable for NC
relief ground

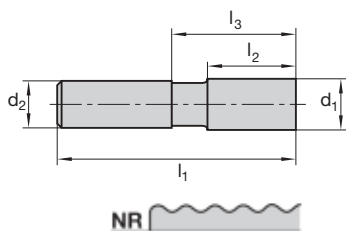

Katalog-Nr.	Cat.-No.	F 506	F 506 C	F 516	F 516 C
Typ	Type	NR			
Norm	Standard	DIN 844 A		DIN 844 B	
Drallwinkel	Helix angle	≈ 30°			
Zylinderschaft	Straight shank	DIN 1835 A		DIN 1835 B	
Beschichtung	Coating	-	TiCN Plus	-	TiCN Plus
Werkstoff	Material	HSS-E-PM			

d ₁ k 12	l ₂	l ₁	l ₃	d ₂ h 6	z	Ident No.	Ident No.	Ident No.	Ident No.
6	24	68	32	6	4	1300671	1120653	1163875	1163895
8	38	88	47	10	4	1300672	1120654	1163877	1163897
10	45	95	57	10	4	1300673	1120655	1163879	1163899
12	53	110	65	12	4	1300674	1120656	1163883	1163901
14	53	110	65	12	4	1300675	1120657	1120673	1120685
16	63	123	75	16	4	1300676	1120658	1163885	1163903
18	63	123	75	16	4	1300678	1120659	1120674	1120686
20	75	141	91	20	4	1300679	1120660	1163887	1163905
25	90	166	110	25	4	1300680	1120661	1163889	1163907
30	90	166	110	25	5	1300681	1120662	1163891	1163909
32	106	186	126	32	6	1300682	1120663	1163893	1163911

Sonderausführungen und andere Beschichtungen auf Anfrage
Special designs and other coatings on request

Schnittwertempfehlungen ab Seite 408
Cutting data recommendations starting page 408

stirnseitig bis Mitte schneidend
NC-gerecht
hinterschliffen

center cutting
 suitable for NC
 relief ground

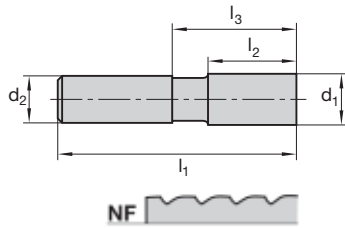

Katalog-Nr.	Cat.-No.	F 505	F 505 C	F 515	F 515 C
Typ	Type	NF			
Norm	Standard	DIN 844 A		DIN 844 B	
Drallwinkel	Helix angle	≈ 30°			
Zylinderschaft	Straight shank	DIN 1835 A		DIN 1835 B	
Beschichtung	Coating	-	TiCN Plus	-	TiCN Plus
Werkstoff	Material	HSS-E-PM			

d ₁ k 12	l ₂	l ₁	l ₃	d ₂ h 6	z	Ident No.	Ident No.	Ident No.	Ident No.
6	13	57	21	6	4	1120714	1120744	1136595	1136596
7	16	66	26	10	4	1120715	1120745	1120774	1120786
8	19	69	28	10	4	1120716	1120746	1136597	1136598
9	19	69	28	10	4	1120717	1120747	1120775	1120787
10	22	72	31	10	4	1120718	1120748	1136599	1136600
11	22	79	34	12	4	1120719	1120749	1120776	1120788
12	26	83	38	12	4	1120720	1120750	1136601	1136602
14	26	83	38	12	4	1120721	1120751	1120777	1120789
16	32	92	44	16	4	1120722	1120752	1136603	1136604
18	32	92	44	16	4	1120723	1120753	1120778	1120790
20	38	104	54	20	4	1120724	1120754	1136605	1136606
22	38	104	54	20	4	1120725	1120755	1120779	1120791
24	45	121	65	25	4	1120726	1120756	1120780	1120792
25	45	121	65	25	4	1120727	1120757	1136607	1136608
28	45	121	65	25	4	1120728	1120758	1120781	1120793
30	45	121	65	25	5	1120729	1120759	1136609	1136610
32	53	133	73	32	6	1120730	1120760	1136611	1136612
36	53	133	73	32	6	1120731	1120761	1120782	1120794
40	63	155	85	40	6	1120732	1120762	1120783	1120795

Sonderausführungen und andere Beschichtungen auf Anfrage
 Special designs and other coatings on request

Schnittwertempfehlungen ab Seite 408
 Cutting data recommendations starting page 408

stirnseitig bis Mitte schneidend
NC-gerecht
hinterschliffen

center cutting
suitable for NC
relief ground

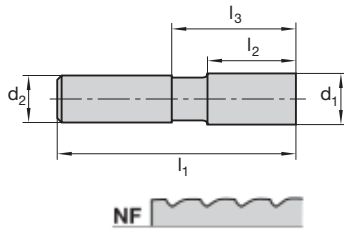

Katalog-Nr.	Cat.-No.	F 505	F 505 C	F 515	F 515 C
Typ	Type	NF			
Norm	Standard	DIN 844 A		DIN 844 B	
Drallwinkel	Helix angle	≈ 30°			
Zylinderschaft	Straight shank	DIN 1835 A		DIN 1835 B	
Beschichtung	Coating	-	TiCN Plus	-	TiCN Plus
Werkstoff	Material	HSS-E-PM			

d ₁ k 12	l ₂	l ₃	l ₃	d ₂ h 6	z	Ident No.	Ident No.	Ident No.	Ident No.
6	24	68	32	6	4	1120733	1120763	1136576	1136577
8	38	88	47	10	4	1120734	1120764	1136578	1136579
10	45	95	57	10	4	1120735	1120765	1136580	1136581
12	53	110	65	12	4	1120736	1120766	1136582	1136583
14	53	110	65	12	4	1120737	1120767	1120784	1120796
16	63	123	75	16	4	1120738	1120768	1136584	1136585
18	63	123	75	16	4	1120739	1120769	1120785	1120797
20	75	141	91	20	4	1120740	1120770	1136586	1136587
25	90	166	110	25	4	1120741	1120771	1136588	1136589
30	90	166	110	25	5	1120742	1120772	1136590	1136591
32	106	186	126	32	6	1120743	1120773	1136592	1136593

Sonderausführungen und andere Beschichtungen auf Anfrage
Special designs and other coatings on request

Schnittwertempfehlungen ab Seite 408
Cutting data recommendations starting page 408

stirnseitig bis Mitte schneidend
NC-gerecht
hinterschliffen

center cutting
 suitable for NC
 relief ground

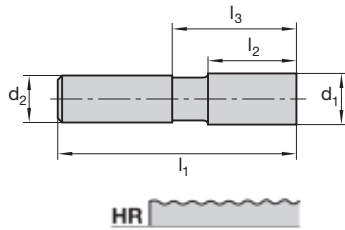

Katalog-Nr.	Cat.-No.	F 509	F 509 C	F 519	F 519 C
Typ	Type	HR			
Norm	Standard	DIN 327 B		DIN 327 D	
Drallwinkel	Helix angle	≈ 30°			
Zylinderschaft	Straight shank	DIN 1835 A		DIN 1835 B	
Beschichtung	Coating	-	TiCN Plus	-	TiCN Plus
Werkstoff	Material	HSS-E-PM			

d ₁ k 12	l ₂	l ₁	l ₃	d ₂ h 6	z	Ident No.	Ident No.	Ident No.	Ident No.
6	8	52	16	6	4	1300459	1300499	1140402	1140421
8	11	61	21	10	4	1300460	1300500	1147671	1147695
10	13	63	23	10	4	1300461	1300501	1147673	1147696
12	16	73	28	12	4	1300462	1300502	1147676	1147698
16	19	79	31	16	4	1300464	1300503	1147678	1147700
20	22	88	38	20	5	1300465	1300504	1147680	1147702
25	26	102	46	25	5	1300466	1300505	1147682	1147704
30	26	102	46	25	6	1300467	1300507	1147416	1140433
32	32	112	52	32	6	1300468	1300508	1147418	1140436

Sonderausführungen und andere Beschichtungen auf Anfrage
 Special designs and other coatings on request

Schnittwertempfehlungen ab Seite 408
 Cutting data recommendations starting page 408

stirnseitig bis Mitte schneidend
NC-gerecht
hinterschliffen

center cutting
suitable for NC
relief ground

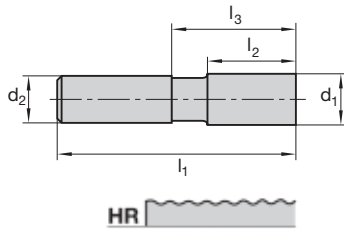

Katalog-Nr.	Cat.-No.	F 509	F 509 C	F 519	F 519 C
Typ	Type	HR			
Norm	Standard	DIN 844 A		DIN 844 B	
Drallwinkel	Helix angle	≈ 30°			
Zylinderschaft	Straight shank	DIN 1835 A		DIN 1835 B	
Beschichtung	Coating	-	TiCN Plus	-	TiCN Plus
Werkstoff	Material	HSS-E-PM			

d ₁ k 12	l ₂	l ₁	l ₃	d ₂ h 6	z	Ident No.	Ident No.	Ident No.	Ident No.
6	13	57	21	6	4	1300469	1300509	1300538	1136704
8	19	69	28	10	4	1300470	1300510	1300539	1136706
10	22	72	31	10	4	1300471	1300511	1300540	1136708
12	26	83	38	12	4	1300472	1300512	1300541	1136710
14	26	83	38	12	4	1300473	1300513	1300542	1300567
16	32	92	44	16	4	1300474	1300514	1300543	1136712
18	32	92	44	16	4	1300475	1300515	1300544	1300568
20	38	104	54	20	5	1300476	1300516	1300545	1136714
22	38	104	54	20	5	1300477	1300517	1300546	1300569
25	45	121	65	25	5	1300478	1300518	1300547	1136716
28	45	121	65	25	5	1300479	1300519	1300548	1300570
30	45	121	65	25	6	1300480	1300520	1300549	1136718
32	53	133	73	32	6	1300482	1300521	1300550	1136722
36	53	133	73	32	6	1300483	1300522	1300552	1300571
40	63	155	85	40	6	1300484	1300523	1300553	1300572

Sonderausführungen und andere Beschichtungen auf Anfrage
Special designs and other coatings on request

Schnittwertempfehlungen ab Seite 408
Cutting data recommendations starting page 408



stirnseitig bis Mitte schneidend
NC-gerecht
hinterschliffen

center cutting
 suitable for NC
 relief ground

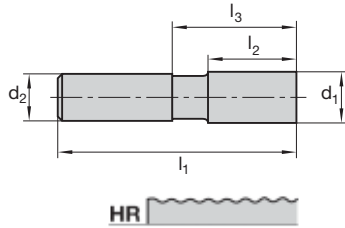

Katalog-Nr.	Cat.-No.	F 509	F 509 C	F 519	F 519 C
Typ	Type	HR			
Norm	Standard	DIN 844 A		DIN 844 B	
Drallwinkel	Helix angle	≈ 30°			
Zylinderschaft	Straight shank	DIN 1835 A		DIN 1835 B	
Beschichtung	Coating	-	TiCN Plus	-	TiCN Plus
Werkstoff	Material	HSS-E-PM			

d ₁ k 12	l ₂	l ₁	l ₃	d ₂ h 6	z	Ident No.	Ident No.	Ident No.	Ident No.
6	24	68	32	6	4	1300485	1300524	1300554	1136707
8	38	88	47	10	4	1300486	1300525	1300555	1136709
10	45	35	57	10	4	1300487	1300526	1300556	1136711
12	53	110	65	12	4	1300488	1300527	1300557	1136713
14	53	110	65	12	4	1300489	1300528	1300558	1300573
16	63	123	75	16	4	1300491	1300529	1300559	1136715
18	63	123	75	16	4	1300492	1300530	1300560	1300574
20	75	141	91	20	5	1300493	1300531	1300561	1136717
25	90	166	110	25	5	1300494	1300532	1300562	1136719
30	90	166	110	25	6	1300495	1300534	1300563	1136721
32	106	186	126	32	6	1300496	1300535	1300564	1136723
36	106	186	126	32	6	1300497	1300536	1300565	1300575

Sonderausführungen und andere Beschichtungen auf Anfrage
 Special designs and other coatings on request

Schnittwertempfehlungen ab Seite 408
 Cutting data recommendations starting page 408

AIRline-Schaftfräser, Zwei- und Dreischneider, lang AIRline-End Mills, Two and Three Flutes, long

stirnseitig bis Mitte schneidend

PM-Schnellstahl

NC-gerecht

hinterschliffen

center cutting

PM-high-speed steel

suitable for NC

relief ground

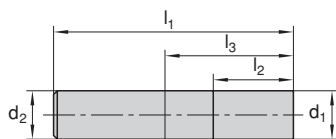

Katalog-Nr.	Cat.-No.	F 525
Bevorzugte Anwendung	Primary application	Aluminium/Thermoplaste Aluminium/Thermoplastics
Typ	Type	SHR
Norm	Standard	DIN 844 B
Drallwinkel	Helix angle	20° Rechtsdrall 20° R. H. Spiral
Zylinderschaft	Straight shank	DIN 1835 B ¹⁾
Schneidstoff	Cutting material	HSS-E-PM

d ₁ k 10	l ₂	l ₃	l ₁	d ₂ h 6	z	Ident No.
8	38	47	88	10	2	1121953
10	45	57	95	10	2	1121954
12	53	65	110	12	3	1121955
14	53	65	110	12	3	1121956
16	63	75	123	16	3	1121957
18	63	75	123	16	3	1121958
20	75	91	141	20	3	1121959
25	90	110	166	25	3	1121960
30	90	110	166	25	3	1121961
32	106	126	186	32	3	1121962

¹⁾ Schaftausführung nach DIN 1835 A kurzfristig lieferbar.

¹⁾ Shank type to DIN 1835 A available at short notice.

Schnittwertempfehlungen ab Seite 408

Cutting data recommendations starting page 408

stirnseitig bis Mitte schneidend
 runde Stirn
 NC-gerecht
 hinterschliften

center cutting
 ball nose
 suitable for NC
 relief ground

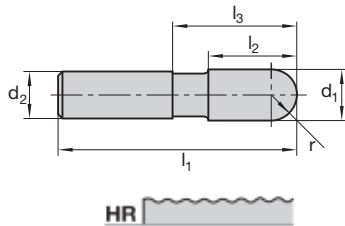

Katalog-Nr.	Cat.-No.	F 576	F 576 C	F 586	F 586 C
Typ	Type	HR			
Norm	Standard	DIN 1889 / 1 BA		DIN 1889 / 1 BB	
Drallwinkel	Helix angle	≈ 30°			
Zylinderschaft	Straight shank	DIN 1835 A		DIN 1835 B	
Beschichtung	Coating	-	TiCN Plus	-	TiCN Plus
Werkstoff	Material	HSS-E-PM			

d ₁ k 12	r	l ₂	l ₁	l ₃	d ₂ h 6	z	Ident No.	Ident No.	Ident No.	Ident No.
6	3	13	57	21	6	4	1300173	1300191	1172093	1172095
8	4	19	69	28	10	4	1300174	1300192	1172100	1172097
10	5	22	72	31	10	4	1300175	1300193	1172119	1172099
12	6	26	83	38	12	4	1300176	1300194	1172128	1172102
16	8	32	92	44	16	4	1300177	1300195	1172146	1172104
20	10	38	104	54	20	5	1300179	1300197	1172164	1172106
25	12,5	45	121	65	25	5	1300180	1300198	1172182	1172108
32	16	53	133	73	32	6	1300181	1300199	1172208	1172110

Sonderausführungen und andere Beschichtungen auf Anfrage
 Special designs and other coatings on request

Schnittwertempfehlungen ab Seite 408
 Cutting data recommendations starting page 408

stirnseitig bis Mitte schneidend
NC-gerecht
hinterschliffen

center cutting
suitable for NC
relief ground

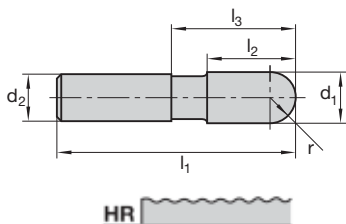

Katalog-Nr.	Cat.-No.	F 576	F 576 C	F 586	F 586 C
Typ	Type	HR			
Norm	Standard	DIN 1889 / 1 BA		DIN 1889 / 1 BB	
Drallwinkel	Helix angle	≈ 30°			
Zylinderschaft	Straight shank	DIN 1835 A		DIN 1835 B	
Beschichtung	Coating	-	TiCN Plus	-	TiCN Plus
Werkstoff	Material	HSS-E-PM			

d ₁ k 12	r	l ₂	l ₁	l ₃	d ₂ h 6	z	Ident No.	Ident No.	Ident No.	Ident No.
6	3	24	68	32	6	4	1300182	1300200	1172262	1300208
8	4	38	88	47	10	4	1300183	1300201	1172271	1300209
10	5	45	95	57	10	4	1300184	1300202	1172253	1300210
12	6	53	110	65	12	4	1300185	1300203	1172137	1300211
16	8	63	123	75	16	4	1300186	1300204	1172155	1300213
20	10	75	141	91	20	5	1300188	1300205	1172173	1300214
25	12,5	90	166	110	25	5	1300189	1300206	1172191	1300215
32	16	106	186	126	32	6	1300190	1300207	1172217	1300216

Sonderausführungen und andere Beschichtungen auf Anfrage
Special designs and other coatings on request

Schnittwertempfehlungen ab Seite 408
Cutting data recommendations starting page 408

stirnseitig bis Mitte schneidend
NC-gerecht
hinterschliffen

center cutting
 suitable for NC
 relief ground

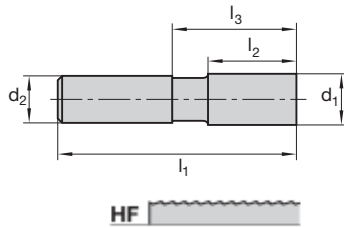

Katalog-Nr.	Cat.-No.	F 507	F 507 C	F 517	F 517 C
Typ	Type	HF			
Norm	Standard	DIN 844 A		DIN 844 B	
Drallwinkel	Helix angle	≈ 30°			
Zylinderschaft	Straight shank	DIN 1835 A		DIN 1835 B	
Beschichtung	Coating	-	TiCN Plus	-	TiCN Plus
Werkstoff	Material	HSS-E-PM			

d ₁ k 12	l ₂	l ₁	l ₃	d ₂ h 6	z	Ident No.	Ident No.	Ident No.	Ident No.
6	13	57	21	6	4	1120813	1120840	1120867	1136632
8	19	69	28	10	4	1120814	1120841	1120868	1136634
10	22	72	31	10	4	1120815	1120842	1120869	1136636
12	26	83	38	12	4	1120816	1120843	1120870	1136638
14	26	83	38	12	4	1120817	1120844	1120871	1120804
16	32	92	44	16	4	1120818	1120845	1120872	1136640
18	32	92	44	16	4	1120819	1120846	1120873	1120805
20	38	104	54	20	5	1120820	1120847	1120874	1136642
22	38	104	54	20	5	1120821	1120848	1120875	1120806
25	45	121	65	25	5	1120822	1120849	1120876	1136644
28	45	121	65	25	5	1120823	1120850	1120877	1120807
30	45	121	65	25	5	1120824	1120851	1120878	1136646
32	53	133	73	32	6	1120825	1120852	1120879	1136648
36	53	133	73	32	6	1120826	1120853	1120880	1120808
40	63	155	85	40	6	1120827	1120854	1120881	1120809

Sonderausführungen und andere Beschichtungen auf Anfrage
 Special designs and other coatings on request

Schnittwertempfehlungen ab Seite 408
 Cutting data recommendations starting page 408

stirnseitig bis Mitte schneidend
NC-gerecht
hinterschliffen

center cutting
suitable for NC
relief ground

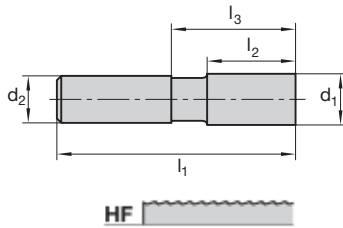

Katalog-Nr.	Cat.-No.	F 507	F 507 C	F 517	F 517 C
Typ	Type	HF			
Norm	Standard	DIN 844 A		DIN 844 B	
Drallwinkel	Helix angle	≈ 30°			
Zylinderschaft	Straight shank	DIN 1835 A		DIN 1835 B	
Beschichtung	Coating	-	TiCN Plus	-	TiCN Plus
Werkstoff	Material	HSS-E-PM			

d ₁ k 12	l ₂	l ₁	l ₃	d ₂ h 6	z	Ident No.	Ident No.	Ident No.	Ident No.
6	24	68	32	6	4	1120828	1120855	1120882	1136633
8	38	88	47	10	4	1120829	1120856	1120883	1136635
10	45	95	57	10	4	1120830	1120857	1120884	1136637
12	53	110	65	12	4	1120831	1120858	1120885	1136639
14	53	110	65	12	4	1120832	1120859	1120886	1120810
16	63	123	75	16	4	1120833	1120860	1120887	1136641
18	63	123	75	16	4	1120834	1120861	1120888	1120811
20	75	141	91	20	5	1120835	1120862	1120889	1136643
25	90	166	110	25	5	1120836	1120863	1120890	1136645
30	90	166	110	25	6	1120837	1120864	1120891	1136647
32	106	186	126	32	6	1120838	1120865	1120892	1136649
36	106	186	126	32	6	1120839	1120866	1120893	1120812

Sonderausführungen und andere Beschichtungen auf Anfrage
Special designs and other coatings on request

Schnittwertempfehlungen ab Seite 408
Cutting data recommendations starting page 408

stirnseitig bis Mitte schneidend
 NC-gerecht

center cutting
 suitable for NC

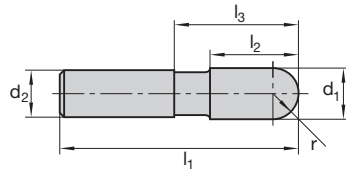

Katalog-Nr.	Cat.-No.	F 454	F 454 C
Typ	Type	N	
Norm	Standard	DIN 327 D	
Drallwinkel	Helix angle	≈ 30°	
Zylinderschaft	Straight shank	DIN 1835 B	
Beschichtung	Coating	-	TiCN Plus
Werkstoff	Material	HSS-E-PM	

d ₁ h 10	r	l ₂	l ₁	l ₃	d ₂ h 6	Ident No.	Ident No.
2	1	4	48	12	6	1300577	1125837
3	1,5	5	49	13	6	1300578	1125839
4	2	7	51	15	6	1300579	1125841
5	2,5	8	52	16	6	1300580	1125843
6	3	8	52	16	6	1300581	1125845
8	4	11	61	21	10	1300582	1125847
10	5	13	63	23	10	1300583	1125851
12	6	16	73	28	12	1300584	1125853
16	8	19	79	31	16	1300585	1125855
20	10	22	88	38	20	1300586	1125857
25	12,5	26	102	46	25	1300587	1125859

Schnittwertempfehlungen ab Seite 408
 Cutting data recommendations starting page 408

stirnseitig bis Mitte schneidend
NC-gerecht

center cutting
suitable for NC

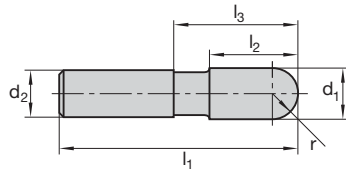

Katalog-Nr.	Cat.-No.	F 454	F 454 C
Typ	Type	N	
Norm	Standard	DIN 844 B	
Drallwinkel	Helix angle	≈ 30°	
Zylinderschaft	Straight shank	DIN 1835 B	
Beschichtung	Coating	-	TiCN Plus
Werkstoff	Material	HSS-E-PM	

d ₁ h 10	r	l ₂	l ₁	l ₃	d ₂ h 6	Ident No.	Ident No.
2	1	7	54	15	6	1300588	1125863
3	1,5	8	56	16	6	1300589	1125865
4	2	11	63	19	6	1300590	1125867
5	2,5	13	68	21	6	1300591	1125869
6	3	13	68	21	6	1300592	1125871
8	4	19	88	28	10	1300593	1125873
10	5	22	95	31	10	1300594	1125875
12	6	26	110	38	12	1300595	1125877
16	8	32	123	44	16	1300596	1125879
20	10	38	141	54	20	1300597	1125881
25	12,5	45	166	65	25	1300598	1125883

Schnittwertempfehlungen ab Seite 408
Cutting data recommendations starting page 408

stirnseitig bis Mitte schneidend
 center cutting

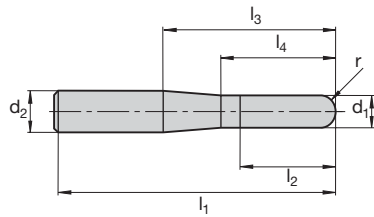

Katalog-Nr.	Cat.-No.	F 511	F 511 C
Typ	Type	N	
Norm	Standard	Werknorm Fette Standard	
Drallwinkel	Helix angle	≈ 30°	
Zylinderschaft	Straight shank	DIN 1835 A	
Beschichtung	Coating	-	TiCN Plus
Werkstoff	Material	HSS-E-PM	

d ₁ ±0,02	r	l ₂	l ₄	l ₁	l ₃	d ₂ h 6	Ident No.	Ident No.
4	2	4,8	28	160	124	8	1300599	1120060
6	3	7,2	38	160	120	10	1300600	1120061
8	4	9,6	49	160	115	12	1300601	1120062
10	5	12	57	160	115	12	1300602	1120063
12	6	14,4	63	200	152	16	1300603	1120064
16	8	19,2	73	200	150	20	1300605	1120065

Schnittwertempfehlungen ab Seite 408
 Cutting data recommendations starting page 408

stirnseitig bis Mitte schneidend
NC-gerecht

center cutting
suitable for NC

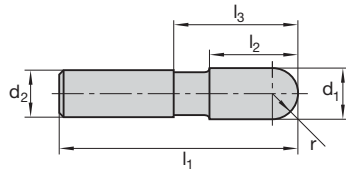

Katalog-Nr.	Cat.-No.	F 581	F 581 C	F 582	F 582 C
Typ	Type	H			
Norm	Standard	DIN 1889 / 1 BA		DIN 1889 / 1 BB	
Drallwinkel	Helix angle	≈ 30°		≈ 30°	
Zylinderschaft	Straight shank	DIN 1835 A		DIN 1835 B	
Beschichtung	Coating	-	TiCN Plus	-	TiCN Plus
Werkstoff	Material	HSS-E-PM			

d ₁ k 12	r	l ₂	l ₁	l ₃	d ₂ h 6	z	Ident No.	Ident No.	Ident No.	Ident No.
6	3	13	57	21	6	4	1300314	1300331	1168491	1168493
8	4	19	69	28	10	4	1300315	1300332	1168507	1168495
10	5	22	72	31	10	4	1300316	1300333	1168516	1168497
12	6	26	83	38	12	4	1300317	1300334	1168525	1168499
16	8	32	92	44	16	4	1300318	1300335	1168543	1168501
20	10	38	104	54	20	5	1300319	1300336	1168561	1168503
25	12,5	45	121	65	25	6	1300320	1300337	1168589	1168505
32	16	53	133	73	32	6	1300321	1300338	1168605	1168509

Sonderausführungen und andere Beschichtungen auf Anfrage
Special designs and other coatings on request

Schnittwertempfehlungen ab Seite 408
Cutting data recommendations starting page 408

stirnseitig bis Mitte schneidend
NC-gerecht

center cutting
 suitable for NC

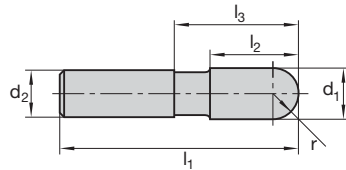

Katalog-Nr.	Cat.-No.	F 581	F 581 C	F 582	F 582 C
Typ	Type	H			
Norm	Standard	DIN 1889 / 1 BA		DIN 1889 / 1 BB	
Drallwinkel	Helix angle	≈ 30°		≈ 30°	
Zylinderschaft	Straight shank	DIN 1835 A		DIN 1835 B	
Beschichtung	Coating	-	TiCN Plus	-	TiCN Plus
Werkstoff	Material	HSS-E-PM			

d ₁ k 12	r	l ₂	l ₁	l ₃	d ₂ h 6	z	Ident No.	Ident No.	Ident No.	Ident No.
6	3	24	68	32	6	4	1300322	1300339	1168669	1300348
8	4	38	88	47	10	4	1300323	1300340	1168678	1300349
10	5	45	95	57	10	4	1300324	1300341	1168650	1300350
12	6	53	110	65	12	4	1300325	1300342	1168534	1300351
16	8	63	123	75	16	4	1300326	1300343	1168552	1300352
20	10	75	141	91	20	5	1300327	1300344	1168570	1300353
25	12,5	90	166	110	25	6	1300328	1300345	1168598	1300354
32	16	106	186	126	32	6	1300330	1300346	1168614	1300355

Sonderausführungen und andere Beschichtungen auf Anfrage
 Special designs and other coatings on request

Schnittwertempfehlungen ab Seite 408
 Cutting data recommendations starting page 408

stirnseitig bis Mitte schneidend
für Kunststoffbearbeitung
(Industrieplastilin etc.)

center cutting
for machining plastic
material (for example
Industry plastilin)

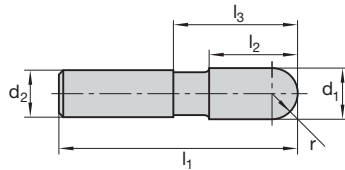

Katalog-Nr.	Cat.-No.	F 434 C
Typ	Type	N
Norm	Standard	Werknorm Fette Standard
Drallwinkel	Helix angle	≈ 30°
Zylinderschaft	Straight shank	DIN 1835 A
Beschichtung	Coating	TiCN Plus
Werkstoff	Material	HSS-E-PM

d ₁	r	l ₂	l ₁	l ₃	d ₂ h 6	Ident No.
4	2	30	80	44	8	2307782
5	2,5	30	80	44	8	2333420
6	3	50	100	64	8	2307784
8	4	50	100	64	8	2333421
10	5	50	100	60	10	2307785
16	8	50	100	60	16	2307786
20	10	50	100	55	20	2307787
30	15	50	100	55	20	2333422

Sonderausführungen und andere Beschichtungen auf Anfrage
Special designs and other coatings on request

Schnittwertempfehlungen ab Seite 408
Cutting data recommendations starting page 408

stirnseitig bis Mitte schneidend
für Kunststoffbearbeitung
(Industriplastilin etc.)

center cutting
for machining plastic
material (for example
Industry plastilin)

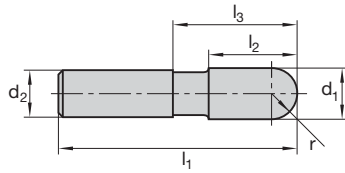

Katalog-Nr.	Cat.-No.	F 434 C
Typ	Type	N
Norm	Standard	Werknorm Fette Standard
Drallwinkel	Helix angle	≈ 30°
Zylinderschaft	Straight shank	DIN 1835 A
Beschichtung	Coating	TiCN Plus
Werkstoff	Material	HSS-E-PM

d ₁	r	l ₂	l ₁	l ₃	d ₂ h 6	Ident No.
4	2	30	130	94	8	2307783
5	2,5	30	130	94	8	2333423
6	3	50	150	114	8	2333424
8	4	50	150	114	8	2333688
10	5	50	150	110	10	2333425
16	8	100	200	160	16	2333426
20	10	100	200	155	20	2307545
30	15	100	200	155	20	2307788

stirnseitig bis Mitte schneidend
center cutting

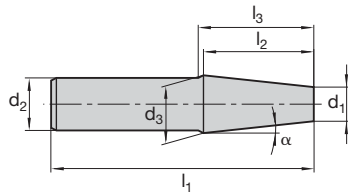

Katalog-Nr.	Cat.-No.	F 593	F 593 C
Typ	Type	H	
Norm	Standard	Werknorm Fette Standard	
Drallwinkel	Helix angle	30° konstant constant	
Zylinderschaft	Straight shank	DIN 1835 A	
Beschichtung	Coating	-	TiCN Plus
Werkstoff	Material	HSS-E-PM	

d ₁ k 12	d ₃	l ₂	l ₁	l ₃	d ₂	Ident No.	Ident No.
$\alpha = \text{Schneidenneigung } 1^\circ, \text{Kegelwinkel } 2^\circ$ Cutting Edge Inclination 1°, Taper Angle 2°							
6	7	30	85	49	6	1121411	1120000
6	7,7	50	105	69	6	1121446	1120001
8	9	30	85	49	8	1121412	1120002
8	9,7	50	105	69	8	1121447	1120003
10	11	30	85	45	10	1121413	1120004
10	12,1	60	115	75	10	1121448	1120005
12	13	30	90	45	12	1121414	1120006
12	14,1	60	120	75	12	1121449	1120007
16	17	30	95	47	16	1121416	1120008
16	18,1	60	125	77	16	1121450	1120009
$\alpha = \text{Schneidenneigung } 2^\circ, \text{Kegelwinkel } 4^\circ$ Cutting Edge Inclination 2°, Taper Angle 4°							
6	8,1	30	85	49	6	1121417	1120010
6	9,5	50	105	69	8	1121452	1120011
8	10,1	30	85	49	8	1121418	1120012
8	11,5	50	105	65	10	1121453	1120013
10	12,1	30	85	45	10	1121419	1120014
10	14,2	60	120	75	12	1121454	1120015
12	14,1	30	90	45	12	1121420	1120016
12	16,2	60	125	77	16	1121455	1120017
16	18,1	30	95	47	16	1121421	1120018
16	20,2	60	125	75	20	1121456	1120019

Sonderausführungen und andere Beschichtungen auf Anfrage
Special designs and other coatings on request

Schnittwertempfehlungen ab Seite 408
Cutting data recommendations starting page 408



stirnseitig bis Mitte schneidend
center cutting



Katalog-Nr.	Cat.-No.	F 593	F 593 C
Typ	Type	H	
Norm	Standard	Werknorm Fette Standard	
Drallwinkel	Helix angle	30° konstant constant	
Zylinderschaft	Straight shank	DIN 1835 A	
Beschichtung	Coating	-	TiCN Plus
Werkstoff	Material	HSS-E-PM	

d ₁ k 12	d ₃	l ₂	l ₁	l ₃	d ₂	Ident No.	Ident No.
$\alpha = \text{Schneidenneigung } 3^\circ, \text{ Kegelwinkel } 6^\circ \text{ Cutting Edge Inclination } 3^\circ, \text{ Taper Angle } 6^\circ$							
6	9,1	30	85	49	8	1121422	1120020
6	11,2	50	105	65	10	1121457	1120021
8	11,1	30	85	45	10	1121425	1120022
8	13,2	50	110	65	12	1121458	1120023
10	13,1	30	90	45	12	1121426	1120024
10	16,3	60	125	77	16	1121459	1120025
12	15,1	30	90	45	12	1121427	1120026
12	18,3	60	125	77	16	1121461	1120027
16	19,1	30	95	47	16	1121428	1120028
16	22,3	60	125	75	20	1121462	1120029
$\alpha = \text{Schneidenneigung } 4^\circ, \text{ Kegelwinkel } 8^\circ \text{ Cutting Edge Inclination } 4^\circ, \text{ Taper Angle } 8^\circ$							
6	10,2	30	85	45	10	1121429	1120030
6	13	50	110	65	12	1121463	1120031
8	12,2	30	90	45	12	1121430	1120032
8	15	50	110	65	12	1121464	1120033
10	14,2	30	90	45	12	1121431	1120034
10	18,4	60	125	77	16	1121465	1120035
12	16,2	30	90	42	16	1121432	1120036
12	20,4	60	125	75	20	1121466	1120037
16	20,2	30	95	45	20	1121434	1120038
16	24,4	60	125	75	20	1121467	1120039

Sonderausführungen und andere Beschichtungen auf Anfrage
 Special designs and other coatings on request

Schnittwertempfehlungen ab Seite 408
 Cutting data recommendations starting page 408

stirnseitig bis Mitte schneidend
center cutting

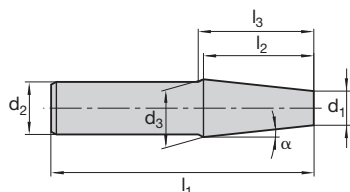

Katalog-Nr.	Cat.-No.	F 593	F 593 C
Typ	Type	H	
Norm	Standard	Werknorm Fette Standard	
Drallwinkel	Helix angle	30° konstant constant	
Zylinderschaft	Straight shank	DIN 1835 A	
Beschichtung	Coating	-	TiCN Plus
Werkstoff	Material	HSS-E-PM	

d ₁ k 12	d ₃	l ₂	l ₁	l ₃	d ₂	Ident No.	Ident No.
$\alpha = \text{Schneidenneigung } 5^\circ, \text{ Kegelwinkel } 10^\circ \text{ Cutting Edge Inclination } 5^\circ, \text{ Taper Angle } 10^\circ$							
6	11,2	30	85	45	10	1121435	1120040
6	14,7	50	110	65	12	1121468	1120041
8	13,2	30	90	45	12	1121436	1120042
8	16,7	50	110	62	16	1121469	1120043
10	15,2	30	90	45	12	1121437	1120044
10	20,5	60	125	77	16	1121470	1120045
12	17,2	30	95	47	16	1121438	1120046
12	22,5	60	125	75	20	1121471	1120047
16	21,2	30	95	45	20	1121439	1120048
16	26,5	60	130	74	25	1121472	1120049
$\alpha = \text{Schneidenneigung } 6^\circ, \text{ Kegelwinkel } 12^\circ \text{ Cutting Edge Inclination } 6^\circ, \text{ Taper Angle } 12^\circ$							
6	12,3	30	90	45	12	1121440	1120050
6	16,5	50	115	67	16	1121473	1120051
8	14,3	30	90	45	12	1121441	1120052
8	18,5	50	115	67	16	1121474	1120053
10	16,3	30	95	47	16	1121443	1120054
10	22,6	60	125	75	20	1121475	1120055
12	18,3	30	95	47	16	1121444	1120056
12	24,6	60	125	75	20	1121476	1120057
16	22,3	30	95	45	20	1121445	1120058
16	28,6	60	130	74	25	1121477	1120059

Sonderausführungen und andere Beschichtungen auf Anfrage
Special designs and other coatings on request

Schnittwertempfehlungen ab Seite 408
Cutting data recommendations starting page 408

stirnseitig bis Mitte schneidend
center cutting

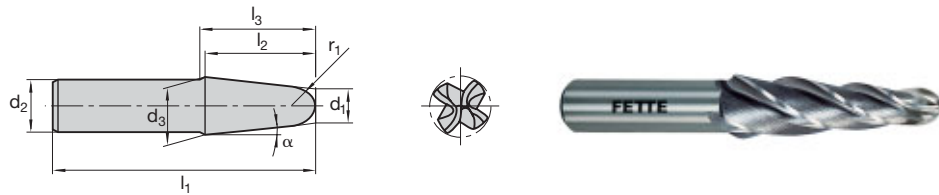

Katalog-Nr.	Cat.-No.	F 594	F 594 C
Typ	Type	H	
Norm	Standard	Werknorm Fette Standard	
Drallwinkel	Helix angle	30° konstant constant	
Zylinderschaft	Straight shank	DIN 1835 A	
Beschichtung	Coating	-	TiCN Plus
Werkstoff	Material	HSS-E-PM	

d ₁ k 12	r ₁	d ₃	l ₂	l ₁	l ₃	d ₂	Ident No.	Ident No.
$\alpha = \text{Schneidenneigung } 1^\circ, \text{Kegelwinkel } 2^\circ \text{ Cutting Edge Inclination } 1^\circ, \text{Taper Angle } 2^\circ$								
6	3,053	7	30	85	49	6	1121478	1120247
6	3,053	7,7	50	105	69	6	1121513	1120248
8	4,07	9	30	85	49	8	1121480	1120249
8	4,07	9,7	50	105	69	8	1121514	1120250
10	5,088	11	30	85	45	10	1121481	1120251
10	5,088	12	60	115	75	10	1121515	1120252
12	6,106	13	30	90	45	12	1121482	1120253
12	6,106	14	60	120	75	12	1121516	1120254
16	8,141	17	30	95	47	16	1121483	1120255
16	8,141	18	60	125	77	16	1121517	1120256
$\alpha = \text{Schneidenneigung } 2^\circ, \text{Kegelwinkel } 4^\circ \text{ Cutting Edge Inclination } 2^\circ, \text{Taper Angle } 4^\circ$								
6	3,107	8,1	30	85	49	6	1121484	1120257
6	3,107	9,5	50	105	69	8	1121518	1120258
8	4,142	10,1	30	85	49	8	1121485	1120259
8	4,142	11,5	50	105	65	10	1121519	1120260
10	5,178	12,1	30	85	45	10	1121486	1120261
10	5,178	14,2	60	120	75	12	1121520	1120262
12	6,213	14,1	30	90	45	12	1121487	1120263
12	6,213	16,2	60	125	77	16	1121522	1120264
16	8,284	18,1	30	95	47	16	1121489	1120265
16	8,284	20,2	60	125	75	20	1121523	1120266

Sonderausführungen und andere Beschichtungen auf Anfrage
 Special designs and other coatings on request

Schnittwertempfehlungen ab Seite 408
 Cutting data recommendations starting page 408



stirnseitig bis Mitte schneidend
center cutting

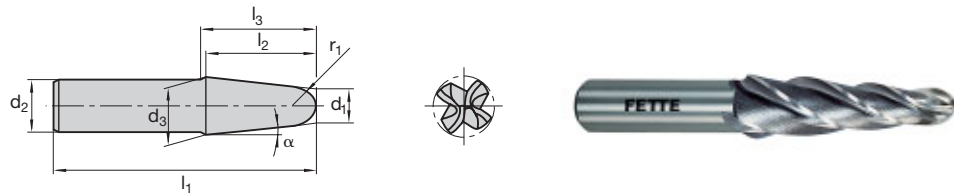

Katalog-Nr.	Cat.-No.	F 594	F 594 C
Typ	Type	H	
Norm	Standard	Werknorm Fette Standard	
Drallwinkel	Helix angle	30° konstant constant	
Zylinderschaft	Straight shank	DIN 1835 A	
Beschichtung	Coating	-	TiCN Plus
Werkstoff	Material	HSS-E-PM	

d, k 12	r ₁	d ₃	l ₂	l ₁	l ₃	d ₂	Ident No.	Ident No.
$\alpha = \text{Schneidenneigung } 3^\circ, \text{Kegelwinkel } 6^\circ \text{ Cutting Edge Inclination } 3^\circ, \text{Taper Angle } 6^\circ$								
6	3,161	9,1	30	85	49	8	1121490	1120267
6	3,161	11,2	50	105	65	10	1121524	1120268
8	4,215	11,1	30	85	45	10	1121491	1120269
8	4,215	13,2	50	110	65	12	1121525	1120270
10	5,269	13,1	30	90	45	12	1121492	1120271
10	5,269	16,3	60	125	77	16	1121526	1120272
12	6,322	15,1	30	90	45	12	1121493	1120273
12	6,322	18,3	60	125	77	16	1121527	1120274
16	8,43	19,1	30	95	47	16	1121494	1120275
16	8,43	22,3	60	125	75	20	1121528	1120276
$\alpha = \text{Schneidenneigung } 4^\circ, \text{Kegelwinkel } 8^\circ \text{ Cutting Edge Inclination } 4^\circ, \text{Taper Angle } 8^\circ$								
6	3,217	10,2	30	85	45	10	1121495	1120277
6	3,217	13	50	110	65	12	1121529	1120278
8	4,289	12,2	30	90	45	12	1121496	1120279
8	4,289	15	50	110	65	12	1121531	1120280
10	5,362	14,2	30	90	45	12	1121498	1120281
10	5,362	18,4	60	125	77	16	1121532	1120282
12	6,434	16,2	30	90	42	16	1121499	1120283
12	6,434	20,4	60	125	75	20	1121533	1120284
16	8,579	20,2	30	95	45	20	1121500	1120285
16	8,579	24,4	60	125	75	20	1121534	1120286

Sonderausführungen und andere Beschichtungen auf Anfrage
Special designs and other coatings on request

Schnittwertempfehlungen ab Seite 408
Cutting data recommendations starting page 408



stirnseitig bis Mitte schneidend
center cutting

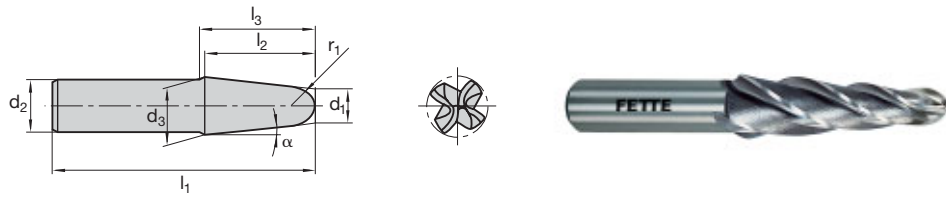

Katalog-Nr.	Cat.-No.	F 594	F 594 C
Typ	Type	H	
Norm	Standard	Werknorm Fette Standard	
Drallwinkel	Helix angle	30° konstant constant	
Zylinderschaft	Straight shank	DIN 1835 A	
Beschichtung	Coating	-	TiCN Plus
Werkstoff	Material	HSS-E-PM	

d ₁ k 12	r ₁	d ₃	l ₂	l ₁	l ₃	d ₂	Ident No.	Ident No.
$\alpha = \text{Schneidenneigung } 5^\circ, \text{Kegelwinkel } 10^\circ \text{ Cutting Edge Inclination } 5^\circ, \text{Taper Angle } 10^\circ$								
6	3,274	11,2	30	85	45	10	1121501	1120287
6	3,274	14,7	50	110	65	12	1121535	1120288
8	4,365	13,2	30	90	45	12	1121502	1120289
8	4,365	16,7	50	110	62	16	1121536	1120290
10	5,457	15,2	30	90	45	12	1121504	1120291
10	5,457	20,5	60	125	77	16	1121537	1120293
12	6,548	17,2	30	95	47	16	1121505	1120294
12	6,548	22,5	60	125	75	20	1121538	1120295
16	8,73	21,2	30	95	45	20	1121506	1120296
16	8,73	26,5	60	130	74	25	1121539	1120297
$\alpha = \text{Schneidenneigung } 6^\circ, \text{Kegelwinkel } 12^\circ \text{ Cutting Edge Inclination } 6^\circ, \text{Taper Angle } 12^\circ$								
6	3,332	12,3	30	90	45	12	1121507	1120298
6	3,332	16,5	50	115	67	16	1121540	1120299
8	4,442	14,3	30	90	45	12	1121508	1120300
8	4,442	18,5	50	115	67	16	1121541	1120301
10	5,553	16,3	30	95	47	16	1121509	1120302
10	5,553	22,6	60	125	75	20	1121542	1120303
12	6,664	18,3	30	95	47	16	1121510	1120304
12	6,664	24,6	60	125	75	20	1121543	1120305
16	8,885	22,3	30	95	45	20	1121511	1120306
16	8,885	28,6	60	130	74	25	1121544	1120307

Sonderausführungen und andere Beschichtungen auf Anfrage
 Special designs and other coatings on request

Schnittwertempfehlungen ab Seite 408
 Cutting data recommendations starting page 408

Werkstoff	Material	R _m /UTS (N/mm ²)	HSS-E-PM TiCN Plus	v _c [m/min]	f _z bei Fräser d ₁ mm f _z at cutter dia. d ₁ mm					Leistungs- faktor Efficiency factor LF
					6	8	12	20	32	
Unlegierter Baustahl	Plain carbon steel	- 700		90	0,052	0,065	0,09	0,12	0,15	20
Automatenstahl	Free cutting steel	- 700		90	0,052	0,065	0,09	0,12	0,15	20
Baustahl	Structural alloy steel	500 - 950		70	0,045	0,06	0,09	0,12	0,15	18
Vergütungsstahl, mittelfest	Heat-treatable steel, medium strength	500 - 950		60	0,045	0,065	0,09	0,12	0,15	18
Stahlguss	Cast steel	- 950		45	0,04	0,052	0,075	0,11	0,12	18
Einsatzstahl	Case hardening steel	- 950		60	0,052	0,065	0,09	0,11	0,15	18
Rost- und säurebeständiger Stahl, ferritisch, martensitisch	Stainless steel, ferritic, martensitic	500 - 950		45	0,045	0,065	0,09	0,12	0,15	16
Vergütungsstahl, hochfest	Heat-treatable steel, high strength	950 - 1400		40	0,04	0,052	0,075	0,1	0,12	13
Nitrierstahl, vergütet	Nitriding steel	950 - 1400		40	0,04	0,052	0,075	0,1	0,12	15
Werkzeugstahl	Tool steel	950 - 1400		35	0,04	0,052	0,075	0,1	0,12	13
Rost- und säurebeständiger Stahl, austenitisch	Stainless steel, austenitic	500 - 950		45	0,052	0,065	0,09	0,12	0,15	15
Martensitaushärtbarer Stahl	Maraging steel	500 - 950		45	0,052	0,065	0,09	0,12	0,15	15
Grauguss	Grey cast iron	100 - 400 (120-260HB)		90	0,078	0,09	0,12	0,15	0,20	30
Legierter Grauguss	Alloyed grey cast iron	150 - 250 (160-230HB)		60	0,045	0,065	0,09	0,12	0,15	25
Sphäroguss	Nodular cast iron	400 - 800 (120-310HB)		60	0,052	0,065	0,09	0,12	0,15	24
Temperguss	Malleable cast iron	350 - 700 (150-280HB)		90	0,052	0,065	0,09	0,12	0,15	30
Rein-Metalle, weich	Pure metals, soft	- 500		240	0,026	0,04	0,075	0,12	0,15	30
Aluminium-Legierungen, langspanend	Aluminium alloys, long chipping	- 550		450	0,026	0,04	0,075	0,12	0,15	30
Aluminium-Legierungen, kurzspanend	Aluminium alloys, short chipping	- 400		140	0,026	0,04	0,06	0,12	0,15	25
Kupfer-Legierungen, langspanend	Copper alloys, long chipping	300 - 700		120	0,022	0,03	0,07	0,11	0,15	30
Kupfer-Legierungen, kurzspanend	Copper alloys, short chipping	- 500		90	0,015	0,03	0,05	0,09	0,11	35
Magnesium-Legierungen	Magnesium alloys	160 - 300		350	0,026	0,04	0,06	0,12	0,14	25
Thermoplaste	Thermoplastics	40 - 70		180	0,026	0,04	0,06	0,11	0,14	25
Duroplaste	Duroplastics	20 - 40		120	0,026	0,04	0,06	0,12	0,14	25
Titan-Legierungen, mittelfest	Titanium alloys, medium strength	- 950		30 ¹⁾	0,016	0,024	0,05	0,08	0,1	18
Titan-Legierungen, hochfest	Titanium alloys, high strength	900 - 1400		15 ¹⁾	0,01	0,018	0,03	0,06	0,07	16
Nickelbasis-Legierungen, mittelfest	Nickel based alloys, medium strength	- 950		40	0,048	0,06	0,1	0,12	0,15	18
Nickel-Basis-Legierungen, hochwarmfest	Heat resistant nickel based alloys, high strength	900 - 1400		15	0,028	0,034	0,075	0,09	0,11	14
Hartguss gehärteter Stahl	Chilled cast iron hardened steel	300 - 600		25	0,04	0,052	0,075	0,12	0,12	25

¹⁾ Empfehlung: Fräser unbeschichtet einsetzen mit diesen Werten

¹⁾ Recommended: use uncoated end mills with these values

Drehzahl Speed $n = \frac{v_c \cdot 1000}{\pi \cdot d_1} \cdot f_1$ v_c Tab. Seite 408 Page 408	Vorschubgeschwindigkeit Feed rate $v_f = f_z \cdot z \cdot n \cdot f_2$ f_z Tab. Seite 408 Page 408	a_e = Schnittbreite in mm Width of cut in mm a_p = Schnitttiefe in mm Depth of cut in mm d_1 = Durchmesser in mm Cutter diameter in mm f_1 = Korrekturfaktor für v_c Correction factor v_c f_2 = Korrekturfaktor für v_f Correction factor v_f f_z = Vorschub pro Zahn in mm Feed per tooth in mm LF = Leistungsfaktor in $\text{cm}^3/\text{min}/\text{kW}$ Efficiency factor in $\text{cm}^3/\text{min}/\text{kW}$ n = Drehzahl in min^{-1} Speed in min^{-1} P_e = Spindelleistung in kW Drive power in kW Q = Spanvolumen in cm^3/min Chip volume in cm^3/min v_c = Schnittgeschwindigkeit in m/min Cutting speed in m/min v_f = Vorschubgeschwindigkeit in mm/min Feed rate in mm/min z = Anzahl der Schneiden No. of teeth
Spanvolumen Chip volume $Q = \frac{a_e \cdot a_p \cdot v_f}{1000}$	Spindelleistung Drive power $P_e \approx \frac{Q}{LF}$	

Schnittgeschwindigkeitskorrektur f_1 Cutting speed correction factor f_1

	unbeschichtet uncoated	TiN	TiCN	TiCN Plus	AL Plus
$f_1 =$	0,6	0,8	1	1	1

Vorschubkorrektur f_2 Cutting speed correction factor f_2

Fräser mit Schrapp-Profil Milling Cutters with roughing-profile			
$f_2 =$	1,0	0,8	0,5
Fräser mit Schlicht-Profil Milling Cutters with finishing-profile			
$f_2 =$	1,0	0,7	0,4
Langloch-/Bohrnutenfräser Slotting End Mills		I. Bohren Slotting	II. Fräsen Milling
		$z = 2$	$z = 3$
$f_2 =$		0,3	0,6
			$z = 2$
			$z = 3$
			0,7









Schaftfräser HSS-E

End Mills HSS-E

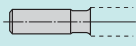
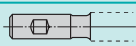
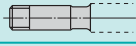
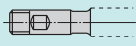
Auswahlübersicht Selection tables	412, 413, 414
Typenbeschreibungen Type descriptions	415
Langloch-/Bohrnutenfräser Slotting End Mills	419
Schaft-Schlichtfräser Finishing End Mills	429
Schaft-Schrupfräser Roughing End Mills	448
Schnittwertempfehlungen Cutting data recommendations	466







Auswahlübersicht Selection table

Langloch-/Bohrnutenfräser Slotting End Mills/Slot Drills

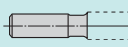
			Seite Page			
Zylinderschaft DIN 1835 A Straight shank		kurz short	419	420		423
		lang long		421	422	424
Mit Mitnahmefläche DIN 1835 B Clamping flat		WN Fette Standard				
		kurz short		420		423
Mit Anzugsgewinde DIN 1835 D With draw bar shank		lang long				424
		kurz short				423
Mit Anzugsgewinde + Mitnahmefläche DIN 1835 B+D With draw bar shank + clamping flat		lang long		421		
		extra lang x-long				427
Morsekegel DIN 228, DIN 2207 Morse taper		kurz short		428		
<ul style="list-style-type: none"> ● sehr gut geeignet well suited ○ auch geeignet also suited 						
Typ			N	N	N	N
≈ Drallwinkel Helix angle			0°	30°	25°-32°	30°
Spanwinkel Rake angle			10°		11°	
			Langlochfräser Slotting End Mills	Bohrnutenfräser, Zweischneider Slot Drills, 2-Flute		Tri-Cut
Werkstoff	Material	R _m /UTS (N/mm ²)				
Unlegierter Baustahl	Plain carbon steel	- 700	●	●	●	●
Automatenstahl	Free cutting steel	- 700	●	●	●	●
Baustahl	Structural low alloy steel	500 - 950	●	●	●	●
Vergütungsstahl, mittelfest	Heat-treatable steel, medium strength	500 - 950	●	●	●	●
Stahlguß	Cast steel	- 950	●	●	●	●
Einsatzstahl	Case hardening steel	- 950	●	●	●	●
Rost- und säurebeständiger Stahl, ferritisch, martensitisch	Stainless steel, ferritic, martensitic	500 - 950			●	●
Vergütungsstahl, hochfest	Heat-treatable steel, high strength	950 - 1400	○	○	○	○
Nitrierstahl, vergütet	Nitriding steel	950 - 1400	○	○	○	○
Werkzeugstahl (bis 45 HRC)	Tool steel (to 45 HRC)	950 - 1400	○	○	○	○
Rost- und säurebeständiger Stahl, austenitisch	Stainless steel, austenitic	500 - 950			●	
Martensitaushärtbarer Stahl	Maraging steel				●	
Grauguß	Grey cast iron	100 - 400 (120 - 260 HB)	●	●	○	●
Legierter Grauguß	Alloyed grey cast iron	150 - 250 (160 - 230 HB)	●	●	○	●
Sphäroguß	Nodular cast iron	400 - 800 (120 - 310 HB)	●	●	○	●
Temperguß	Malleable cast iron	350 - 700 (150 - 280 HB)	●	●	○	●
Rein-Metalle, weich	Pure metals, soft	- 500	○	○	●	○
Aluminium-Legierungen, langspanend	Aluminium alloys, long chipping	- 550	○	○	●	○
Aluminium-Legierungen, kurzspanend	Aluminium alloys, short chipping	- 400	○	○	●	●
Kupfer-Legierungen, langspanend	Copper alloys, long chipping	300 - 700	○	○	●	○
Kupfer-Legierungen, kurzspanend	Copper alloys, short chipping	- 500	○	○	●	●
Magnesium-Legierungen	Magnesium alloys	150 - 300	○	○	●	●
Thermoplaste	Thermoplastics	40 - 70	○	○	●	○
Duroplaste	Duroplastics	20 - 40	○	○	●	●
Graphit	Graphite					
Titanlegierungen, mittelfest	Titanium alloys, medium strength	- 950	○	○	○	○
Titanlegierungen, hochfest	Titanium alloys, high strength	900 - 1400	○	○	○	○
Nickelbasislegierungen, mittelfest	Nickel based alloys, medium strength	- 950	○	○	○	○
Nickelbasislegierungen, hochwarmfest	Heat resistant nickel based alloys, high strength	900 - 1400	○	○	○	○
Hartguß	Chilled cast iron	300 - 600	○	○	○	○



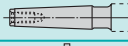

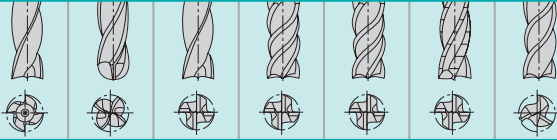





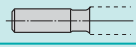
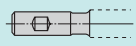
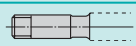





Auswahlübersicht Selection table

Schaft-Schlichtfräser Finishing End Mills

				Seite Page							
Zylinderschaft DIN 1835 A Straight shank		extra kurz stub length						433			
		kurz short			429	431	434				
		lang long			430	432					
Mit Mitnahmefläche DIN 1835 B Clamping flat		extra kurz stub length						433			
		kurz short			429	431	434	435	436		
		lang long			430	432			436		
Mit Anzugsgewinde DIN 1835 D With draw bar shank		kurz short			429						
		lang long			430						
Mit Anzugsgewinde + Mitnahmefläche DIN 1835 B+D With draw bar shank + clamping flat		extra lang x-long	464	465							
Morsekegel DIN 228, DIN 2207 Morse taper		kurz short	438		440	441					
		lang long	439						442		
ISO-Steilkegel DIN 2080 ISO 7:24 taper		kurz short	443								
		lang long	444								
ISO-Steilkegel DIN 69871 ISO 7:24 taper		kurz short	445								
		lang long	446								
<ul style="list-style-type: none"> ● sehr gut geeignet well suited ○ auch geeignet also suited 											
				Typ	N	N	N	SN	SN 50	NVT	W
				≈ Drallwinkel Helix angle	30°	30°	30°	40°	50°	25°	40°
				Spanwinkel Rake angle	11°	11°	11°	16°	16°	8°	22°
	Werkstoff	Material	R _m /UTS (N/mm ²)								
Unlegierter Baustahl Automatenstahl Baustahl Vergütungsstahl, mittelfest Stahlguß Einsatzstahl Rost- und säurebeständiger Stahl, ferritisch, martensitisch Vergütungsstahl, hochfest Nitrierstahl, vergütet Werkzeugstahl (bis 45 HRC)	Unlegierter Baustahl	Plain carbon steel	- 700	●	●	●	●	●	●	●	○
	Automatenstahl	Free cutting steel	- 700	●	●	●	●	●	●	●	○
	Baustahl	Structural low alloy steel	500 - 950	●	●	●	●	●	●	●	○
	Vergütungsstahl, mittelfest	Heat-treatable steel, medium strength	500 - 950	●	●	●	●	●	●	●	
	Stahlguß	Cast steel	- 950	●	●	●	●	●	●	●	
	Einsatzstahl	Case hardening steel	- 950	●	●	●	●	●	●	●	
	Rost- und säurebeständiger Stahl, ferritisch, martensitisch	Stainless steel, ferritic, martensitic	500 - 950	●	●	●	●	●	●	●	○
	Vergütungsstahl, hochfest	Heat-treatable steel, high strength	950 - 1400	○	○	○	○	○			
	Nitrierstahl, vergütet	Nitriding steel	950 - 1400	○	○	○	○	○			
	Werkzeugstahl (bis 45 HRC)	Tool steel (to 45 HRC)	950 - 1400	○	○	○	○	○			
Rost- und säurebeständiger Stahl, austenitisch Martensitaushärtbarer Stahl	Stainless steel, austenitic	500 - 950							●		
	Maraging steel								●		
Grauguß Legierter Grauguß Sphäroguß Temperguß	Grey cast iron	100 - 400 (120 - 260 HB)		●	●	●	○	○	●		
	Alloyed grey cast iron	150 - 250 (160 - 230 HB)		●	●	●	○	○	●		
	Nodular cast iron	400 - 800 (120 - 310 HB)		●	●	●	○	○	●		
	Malleable cast iron	350 - 700 (150 - 280 HB)		●	●	●	○	○	●		
Rein-Metalle, weich Aluminium-Legierungen, langspanend Aluminium-Legierungen, kurzspanend Kupfer-Legierungen, langspanend Kupfer-Legierungen, kurzspanend Magnesium-Legierungen Thermoplaste Duroplaste Graphit	Pure metals, soft	- 500		○	○	○	●	●		●	
	Aluminium alloys, long chipping	- 550		○	○	○	●	●		●	
	Aluminium alloys, short chipping	- 400		●	●	●	●	●	●	○	
	Copper alloys, long chipping	300 - 700		○	○	○	●	●		●	
	Copper alloys, short chipping	- 500		●	●	●	●	●	●	○	
	Magnesium alloys	150 - 300		●	●	●	●	●	●	○	
	Thermoplastics	40 - 70		○	○	○	●	●	●	●	
	Duroplastics	20 - 40		●	●	●	●	●	●	○	
Graphite											
Titanlegierungen, mittelfest Titanlegierungen, hochfest Nickelbasislegierungen, mittelfest Nickelbasislegierungen, hochwarmfest	Titanium alloys, medium strength	- 950		○	○	○	●	●	●	○	
	Titanium alloys, high strength	900 - 1400		○	○	○	●	●	○		
	Nickel based alloys, medium strength	- 950		○	○	○	●	●	○		
	Heat resistant nickel based alloys, high strength	900 - 1400		○	○	○	○	○	○		
Hartguß	Chilled cast iron	300 - 600		○	○	○	○	○	○		









Auswahlübersicht Selection table

Schaft-Schruppfräser Roughing End Mills

			Seite Page						
Zylinderschaft DIN 1835 A Straight shank		kurz short		447	448		450		
		lang long			449		451		
Mit Mitnahmefläche DIN 1835 B Clamping flat		extra kurz stub length						452	
		kurz short		447	448		450	453	
		lang long			449		451		
Mit Anzugsgewinde DIN 1835 D With draw bar shank		kurz short		447	448		450		
		lang long			449		451		
Morsekegel DIN 228, DIN 2207 Morse taper		kurz short	454				456		
		lang long	455				457		
ISO-Steilkegel DIN 2080 ISO 7:24 taper		kurz short	458				460		
		lang long	459				461		
ISO-Steilkegel DIN 69871 ISO 7:24 ,taper'		kurz short	462						
		lang long	463						
<ul style="list-style-type: none"> ● sehr gut geeignet well suited ○ auch geeignet also suited 									
									
			Typ	NR	NR	NR	NF	NF	WF
			≈ Drallwinkel Helix angle	30°	30°	30°	30°	30°	40°
			Spanwinkel Rake angle	11°	11°	11°	11°	11°	22°
Werkstoff	Material	R_m/UTS (N/mm²)							
Unlegierter Baustahl	Plain carbon steel	- 700	●	●	●	●	●	●	○
Automatenstahl	Free cutting steel	- 700	●	●	●	●	●	●	○
Baustahl	Structural low alloy steel	500 - 950	●	●	●	●	●	●	○
Vergütungsstahl, mittelfest	Heat-treatable steel, medium strength	500 - 950	●	●	●	●	●	●	
Stahlguß	Cast steel	- 950	●	●	●	●	●	●	
Einsatzstahl	Case hardening steel	- 950	●	●	●	●	●	●	
Rost- und säurebeständiger Stahl, ferritisch, martensitisch	Stainless steel, ferritic, martensitic	500 - 950	●	●	●	●	●	●	●
Vergütungsstahl, hochfest	Heat-treatable steel, high strength	950 - 1400	○	○	○	●	●	●	
Nitrierstahl, vergütet	Nitriding steel	950 - 1400	○	○	○	●	●	●	
Werkzeugstahl (bis 45 HRC)	Tool steel (to 45 HRC)	950 - 1400	○	○	○	●	●	●	
Rost- und säurebeständiger Stahl, austenitisch	Stainless steel, austenitic	500 - 950	○	○	○	●	●	●	○
Martensitaushärtbarer Stahl	Maraging steel								
Grauguß	Grey cast iron	100 - 400 (120 - 260 HB)	○	○	○	●	●	●	
	Legierter Grauguß	Alloyed grey cast iron (160 - 230 HB)	○	○	○	●	●	●	
	Sphäroguß	Nodular cast iron (120 - 310 HB)	○	○	○	●	●	●	
	Temperguß	Malleable cast iron (150 - 280 HB)	○	○	○	●	●	●	
Rein-Metalle, weich	Pure metals, soft	- 500	○	○	○				●
Aluminium-Legierungen, langspanend	Aluminium alloys, long chipping	- 550	○	○	○				●
Aluminium-Legierungen, kurzspanend	Aluminium alloys, short chipping	- 400	○	○	○	●	●	●	
Kupfer-Legierungen, langspanend	Copper alloys, long chipping	300 - 700	○	○	○				●
Kupfer-Legierungen, kurzspanend	Copper alloys, short chipping	- 500	○	○	○	●	●	●	
Magnesium-Legierungen	Magnesium alloys	150 - 300	○	○	○	●	●	●	
Thermoplaste	Thermoplastics	40 - 70	○	○	○				●
Duroplaste	Duroplastics	20 - 40	○	○	○	●	●	●	
Graphit	Graphite								
Titanlegierungen, mittelfest	Titanium alloys, medium strength	- 950	●	●	●	●	●	●	
Titanlegierungen, hochfest	Titanium alloys, high strength	900 - 1400	○	○	○	○	○	○	
Nickelbasislegierungen, mittelfest	Nickel based alloys, medium strength	- 950	○	○	○	○	○	○	
Nickelbasislegierungen, hochwarmfest	Heat resistant nickel based alloys, high strength	900 - 1400	○	○	○	○	○	○	
Hartguß	Chilled cast iron	300 - 600							

Typenbeschreibung Type description











Schafffräser End Mills

	Langloch- und Bohrnutenfräser Slotting End Mills	DIN (WN = Werknorm Fette Standard)	Cat.-No.	TiCN Plus	Seite Page
Typ N  	Langlochfräser geradenutet bzw. mit 10° Rechtsdrall, Spanwinkel ≈ 11°, ≤ 26 Ø; z = 2, ≥ 28 Ø; z = 4. Zum Fräsen von Paßfedernuten mit geringer Bohrtiefe oder allmählicher Tiefenzustellung. Slotting End Mills with straight flutes, with 10° R. H. spiral, ≈ 11° rake angle, ≤ 26 mm dia. with two flutes, ≥ 28 mm dia.; with four flutes. Milling of driving keyways with low depth or with gradual ramp feed.	327 A	1401	●	419
Typ N  	Bohrnutenfräser, Zweischneider, ≈ 30° Rechtsdrall, zum Tauchen auf volle Tiefe und anschließendem Längsfräsen. Slot Drills, 2 flute, ≈ 30° R. H. spiral, for plunge milling to full depth followed by horizontal milling.	327 B 327 D 327 H	1405 1445 1452 kurz short	1405 C 1445 C 1452 C kurz short	420
		844 A 844 B/D	1405 1452 long long	1405 C 1452 C long long	421
 	Bohrnutenfräser, Zweischneider, mit 45° Schneideckenfase, ≈ 19° bis ≈ 31° Rechtsdrall, Drallsteigung auch passend für Hurth-Schärfleinrichtung mit Leitpatrone. Slot Drills, 2 flute, with 45° cutting edge angle ≈ 19° to ≈ 31° R. H. helix; spiral lead also suitable for Hurth resharpening attachment.	WN	1441	●	422
Typ N  	Tri-Cut-Bohrnutenfräser, Dreischneider, mit gerader Stirn, ≈ 30° Rechtsdrall, Universelle Anwendung: Tauchfräsen auf volle Nutentiefe oder allmähliche Tiefenzustellung, auch als Schafffräser für konventionelles Stirn- und Umfangsfräsen. Tri-Cut-Slot Drills, 3 flute, with square end, appr. 30° R. H. spiral. Universally applicable: plunge milling to full depth or with gradual feed; also for conventional face and periphery milling.	327 B 327 D 327 H	1406 1416 1456 kurz short	1406 C 1416 C 1456 C kurz short	423
		≈ 844 A ≈ 844 B ≈ 844 D	1406 1416 1456 lang long	1406 C 1416 C 1456 C lang long	424
		WN	1409 kurz short	1409 C kurz short	425
		WN	1409 lang long	1409 C lang long	426
		WN	1459 extra lang x-long	●	427

● = Diese Ausführung ist auch mit unseren Standardausführungen TiCN Plus, ALPlus oder anderen PVD-Schichten lieferbar
Also available with standards TiCN Plus, ALPlus or other PVD-coatings

Typenbeschreibung Type description









Schaftfräser End Mills

	Schaft-Schlichtfräser Finishing End Mills	DIN (WN = Werknorm Fette Standard)	Cat.-No.	TiCN Plus	Seite Page
Typ N    	Schaftfräser, $\approx 30^\circ$ Rechtsdrall, Spanwinkel $\approx 11^\circ$, hochstehende Fasen. Großer Anwendungsbereich bei Werkstoffen mittlerer Festigkeit und Härte z. B.: Bau-, Einsatz- und Vergütungsstähle bis ≈ 1200 N/mm ² . Ausführungen: nicht über Mitte und über Mitte schneidend.	844 A 844 B 844 D	1500 1501 1551 kurz short	1500 C 1501 C 1551 C kurz short	429
	End Mills, multi flute $\approx 30^\circ$ R. H. spiral, rake angle $\approx 11^\circ$, raised lands. Wide range of applications for materials having medium strength and hardness, such as: structural-case hardening-, and tempered steels up to ≈ 1200 N/mm ² . Designs: non-center cutting and center cutting.	844 A 844 B 844 D	1500 1501 1551 lang long	1500 C 1501 C 1551 C lang long	430
		WN	1554 extra lang x-long	●	464
		WN	1553 extra lang x-long	●	465
		845 B+C	1530 kurz short	●	438
		845 B+C	1530 lang long	●	439
		845 B+C	1531 kurz short	●	440
		2328	1541 kurz short	●	443
		2328	1541 lang long	●	444
		≈ 2328	1542 kurz short	●	445
		≈ 2328	1542 lang long	●	446
	Typ SN    	Schaftfräser, $\approx 40^\circ$ Rechtsdrall, Spanwinkel $\approx 16^\circ$. Breite, hochstehende Fasen mit balligem Hinterschliff, besonders geeignet für langspanende und/oder zähe Werkstoffe wie rost- und säurebeständige Stähle, Titanlegierungen, warmfeste Stähle – bevorzugt zum Gleichlaufräsen.	844 A 844 B	1503 1523 kurz short	1503 C 1523 C kurz short
End Mills, multi flute $\approx 40^\circ$ R. H. spiral, rake angle $\approx 16^\circ$. Wide raised lands with ground radial relief, specially suited for long chip production and/or tough materials, such as corrosion- and acid resisting steels – climb milling preferred.		844 A 844 B	1503 1523 lang long	1503 C 1523 C lang long	432
 	Wie vor, jedoch mit $\approx 50^\circ$ Rechtsdrall, stirnseitig Mitte schneidend. As above, but with appr. 50° R. H. spiral, center cutting.	DIN 327 B DIN 327 D	1573 1513 extra kurz stub length	1573 C 1513 C extra kurz stub length	433
		844 A 844 B	1573 1513 kurz short	1573 C 1513 C kurz short	434

● = Diese Ausführung ist auch mit unseren Standardausführungen TiCN Plus, ALPlus oder anderen PVD-Schichten lieferbar
 Also available with standards TiCN Plus, ALPlus or other PVD-coatings

Typenbeschreibung Type description











Schaftfräser End Mills

		DIN (WN = Werknorm Fette Standard)	Cat.-No.	TiCN Plus	Seite Page
Schaft-Schlichtfräser Finishing End Mills					
Typ NVT   	Schaftfräser, grobgezahnt, $\approx 25^\circ$ Rechtsdrall, $\approx 8^\circ$ Spanwinkel. Mit breiter Fase, balligem Hinterschliff und versetzt hinterschliffenen Spanteilern, besonders geeignet zum Schlichtfräsen mit hoher Zerspanungsleistung bei gleichzeitig guter Oberfläche. Für Bau-, Einsatz- und Vergütungsstähle bis 1200 N/mm^2 sowie für kurzspanende NE-Metalle und Titanlegierungen. Bis Mitte schneidend. End Mills, multi flute, $\approx 25^\circ$ R. H. spiral, $\approx 8^\circ$ rake angle. With wide land, ground radial relief and staggered relief ground chip breakers, specially suited for finishing operations with a high rate of chip removal, producing at the same time a good surface quality. For structural, case-hardening and tempered steels up to 1200 N/mm^2 , as well as for short chip producing non-ferrous metals and titanium alloys. Center cutting.	844 B	1519	1519 C	435
Typ W  	Schaftfräser, besonders grob gezahnt, $\approx 40^\circ$ Rechtsdrall, Spanwinkel $\approx 22^\circ$. Fräsen von weichen, zähen und/oder langspanenden Werkstoffen, z. B.: Aluminium- und Kupferlegierungen. Stirnseitig bis Mitte schneidend. End Mills, 2-3 flute, $\approx 40^\circ$ R. H. spiral, rake angle $\approx 22^\circ$. Machining of soft, tough and/or long chip producing materials, such as aluminium- and copper alloys. Center cutting.	844 B	1514 kurz short		436
		844 B	1514 lang long		437
Schaft-Schrupfräser Roughing End Mills					
Typ NR    	Schaftfräser, Schrupp-Kordelverzahnung, hinterschliffen, $\approx 25^\circ$ Rechtsdrall, $\approx 11^\circ$ Spanwinkel; rundes Spanteilerprofil, für Schrumperspannung von Stählen mit geringerer bis mittlerer Härte, vorwiegend langspanend, bis $\approx 900 \text{ N/mm}^2$, Titanlegierungen und warmfeste Werkstoffe. End Mills, knuckle type, relief ground, $\approx 25^\circ$ R. H. spiral, $\approx 11^\circ$ rake angle, round chip-breaker profile; for rough machining of low- to medium-hardness steels, mainly long-chip-producing, up to $\approx 900 \text{ N/mm}^2$, titanium alloys and high-temperature materials.	844 A 844 B 844 D	1506 1516 1556 kurz short	1506 C 1516 C 1556 C kurz short	448
		844 A 844 B 844 D	1506 1516 1556 lang long	1506 C 1516 C 1556 C lang long	449
		845 B+C	1536 kurz short	●	454
		845 B+C	1536 lang long	●	455
		2328	1546 kurz short	●	458
		2328	1546 lang long	●	459
		≈ 2328	1547 kurz short	●	462
		≈ 2328	1547 lang long	●	463

● = Diese Ausführung ist auch mit unseren Standardausführungen TiCN Plus, ALPlus oder anderen PVD-Schichten lieferbar
 Also available with standards TiCN Plus, ALPlus or other PVD-coatings

Typenbeschreibung Type description

Schaftfräser End Mills

	Schaft-Schrupfräser Roughing End Mills	DIN (WN = Werknorm Fette Standard)	Cat.-No.	TiCN Plus	Seite Page
Typ NR   	<p>Wie vor, jedoch Ausführung als Dreischneider Tri-Cut mit $\approx 32^\circ$ Rechtsdrall.</p> <p>As above, but 3 flute design Tri-Cut with $\approx 32^\circ$ R. H. spiral.</p>	844 A 844 B 844 D	1427 1467 1477	1427 C 1467 C 1477 C	447
	Typ NF    	<p>Schaftfräser, Schrupp-Schlichtverzahnung, $\approx 25^\circ$ Rechtsdrall, Spanwinkel $\approx 11^\circ$, flaches Spanteilerprofil hinterschleifen, für Schruppzerspanung von Werkstoffen bis $\approx 1100 \text{ N/mm}^2$ Festigkeit sowie Guß und Gußlegierungen.</p> <p>End Mills, truncated type for roughing, $\approx 25^\circ$ R. H. spiral, appr. 11° rake angle, shallow chipbreaker profile relief ground; for rough machining of materials up to $\approx 1100 \text{ N/mm}^2$ tensile strength, also cast iron and alloyed cast iron.</p>	844 A 844 B 844 D	1505 1515 1555 kurz short	1505 C 1515 C 1555 C kurz short
		844 A 844 B 844 D	1505 1515 1555 lang long	1505 C 1515 C 1555 C lang long	451
		845 B+C	1535 kurz short	●	456
		845 B+C	1535 lang long	●	457
		2328	1545 kurz short	●	460
		2328	1545 lang long	●	461
Typ WF   	<p>Tri-Cut-Bohrnutenfräser, Dreischneider, mit grober Schrupp-Schlichtverzahnung, hinterschleifen. $\approx 40^\circ$ Rechtsdrall, Spanwinkel $\approx 22^\circ$ für langspanende Werkstoffe, z. B. Alu- und Cu-Legierungen, weiche Stähle, bevorzugt Gleichlaufräsen.</p> <p>Tri-Cut Slot Drills, 3 flute, coarse-tooth truncated type for roughing, relief ground, appr. 40° R. H. spiral, appr. 22° rake angle; for long chip producing materials such as aluminium and copper alloys, mild steel; preferred for climb milling.</p>	327 D	1414 extra kurz stub length	1414 C extra kurz stub length	452
			844 B	1414 kurz short	1414 C kurz short

● = Diese Ausführung ist auch mit unseren Standardausführungen TiCN Plus, ALPlus oder anderen PVD-Schichten lieferbar
 Also available with standards TiCN Plus, ALPlus or other PVD-coatings

stirnseitig bis Mitte schneidend
NC-gerecht

center cutting
 suitable for NC

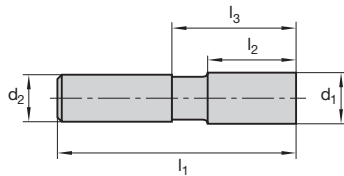

Katalog-Nr.	Cat.-No.	1401
Typ	Type	N
Norm	Standard	DIN 327 A
Drallwinkel	Helix angle	geradegenutet straight fluted
Zylinderschaft	Straight shank	DIN 1835 A
Beschichtung	Coating	-
Werkstoff	Material	HSS-E 909 M 42 ¹⁾

d, e 8	d, h 10	l ₂	l ₁	l ₃	d ₂ h 6	Ident No.
	1	2	36	8	3	1108813
	1,5	3	36	8	3	1108822
2		4	48	12	6	1108831
2,5		5	49	13	6	1108840
3		5	49	13	6	1108859
4		7	51	15	6	1108877
5		8	52	16	6	1108895
6		8	52	16	6	1108911
8		11	61	21	10	1108957
10		13	63	23	10	1108993
12		16	73	28	12	1109037
14		16	73	28	12	1109064
16		19	79	31	16	1109082
18		19	79	31	16	1109108
20		22	88	38	20	1109126

¹⁾ ab Ø 4 mm
¹⁾ starting at Ø 4 mm

Schnittwertempfehlungen ab Seite 466
 Cutting data recommendations starting page 466

Bohrnutenfräser, Zweischneider, kurz Slot Drills, 2-Flute, short

stirnseitig bis Mitte schneidend
NC-gerecht

center cutting
suitable for NC

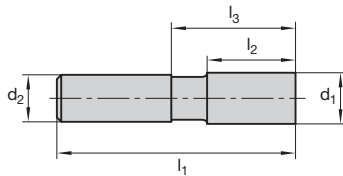

1405



1445



1452



Katalog-Nr.	Cat.-No.	1405	1405 C	1445	1445 C	1452	1452 C
Typ	Type	N					
Norm	Standard	DIN 327 B		DIN 327 D		DIN 327 H	
Drallwinkel	Helix angle	≈ 30°					
Zylinderschaft	Straight shank	DIN 1835 A		DIN 1835 B		DIN 1835 D	
Beschichtung	Coating	-	TiCN Plus	-	TiCN Plus	-	TiCN Plus
Werkstoff	Material	HSS-E 909 M 42					

d ₁ e 8	d ₁ h 10	l ₂	l ₁	l ₃	d ₂ h 6	Ident No.	Ident No.	Ident No.	Ident No.	Ident No.	Ident No.
	1,8	4	48	12	6	1121415	1120639	1122905	1300156	1124403	1300160
2		4	48	12	6	1121424	1120640	1122913	1300157	1123725	1300161
2,5		5	49	13	6	1121442	1121400	1122922	1123260	1123734	1121401
3		5	49	13	6	1121460	1120641	1122931	1123264	1123743	1124314
	3,5	6	50	14	6	1121488	1120642	1122940	1123266	1123752	1124316
	3,8	7	51	15	6	1120613	1120643	1300155	1300158	1124421	1300162
4		7	51	15	6	1121503	1120644	1122959	1123268	1123761	1124323
	4,5	7	51	15	6	1121521	1120645	1122968	1123270	1123770	1124325
5		8	52	16	6	1121549	1120646	1122977	1123272	1123789	1124332
	5,5	8	52	16	6	1121567	1120647	1122986	1123274	1123798	1124334
6		8	52	16	6	1121585	1120648	1122995	1123276	1123805	1124341
	6,5	10	60	20	10	1121601	1120649	1123002	1123278	1123814	1124343
7		10	60	20	10	1121629	1300134	1123011	1123280	1123823	1124350
	7,5	10	60	20	10	1121647	1300135	1123020	1300159	1123832	1124352
8		11	61	21	10	1121665	1300136	1123039	1123284	1123841	1124369
	9	11	61	21	10	1121709	1300137	1123057	1123288	1123869	1124373
	9,5	11	61	21	10	1121727	1300138	1123066	1123290	1123878	1124375
10		13	63	23	10	1121745	1300139	1123075	1123292	1123887	1124387
	11	13	70	25	12	1121781	1300140	1123093	1123294	1123903	1124389
12		16	73	28	12	1121825	1300142	1123119	1123296	1123921	1125304
	13	16	73	28	12	1121843	1300143	1123128	1123298	1123930	1125306
14		16	73	28	12	1121861	1300144	1123137	1123300	1123949	1125322
	15	16	73	28	12	1121889	1300145	1123146	1123302	1123958	1125331
16		19	79	31	16	1121905	1300146	1123155	1123304	1123967	1125340
18		19	79	31	16	1121941	1300147	1123173	1123308	1123985	1125359
20		22	82	38	16	-	-	-	-	1124010	1125363
20		22	88	38	20	1121987	1300148	1123191	1123312	1124001	1125368
22		22	88	38	20	1122003	1300149	1123208	1123314	1124029	1125370
25		26	102	46	25	1122049	1300151	1123226	1123318	1124056	1125374
28		26	102	46	25	1122085	1300152	1123244	1123322	1124074	1125378
	30	26	102	46	25	1122101	1300153	1123253	1123324	1124083	1125380
32		32	112	52	32	1122129	1300154	1123262	1123326	1124092	1125382

Bohrnutenfräser aus HSS-E-PM siehe Kat.-Nr. F 405, F 445, Seite 370
Slot Drills of HSS-E-PM see Cat.-No. F 405 C, F 445 C, Page 370

Schnittwertempfehlungen ab Seite 466
Cutting data recommendations starting page 466



stirnseitig bis Mitte schneidend
 NC-gerecht

center cutting
 suitable for NC

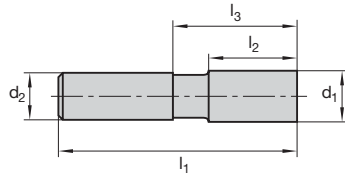

1405



1452



Katalog-Nr.	Cat.-No.	1405	1405 C	1452	1452 C
Typ	Type	N			
Norm	Standard	DIN 844 A		DIN 844 B / D	
Drallwinkel	Helix angle	≈ 30°			
Zylinderschaft	Straight shank	DIN 1835 A		DIN 1835 B / D	
Beschichtung	Coating	-	TiCN Plus	-	TiCN Plus
Werkstoff	Material	HSS-E 909 M 42			

d, e 8	d, h 10	l ₂	l ₁	l ₃	d ₂ h 6	Ident No.	Ident No.	Ident No.	Ident No.
2		7	54	15	6	1120614	1121570	1124617	1122907
2,5		8	56	16	6	1120615	1121571	1124626	1300163
3		8	56	16	6	1120616	1121572	1124635	1122909
	3,5	10	59	18	6	1120617	1121573	1124644	1300164
4		11	63	19	6	1120618	1121574	1124653	1122911
	4,5	11	63	19	6	1120619	1121575	1124662	1300165
5		13	68	21	6	1120620	1121577	1124671	1122915
	5,5	13	68	21	6	1120621	1121578	1124680	1300166
6		13	68	21	6	1120622	1121579	1124699	1122917
	6,5	16	80	26	10	1120623	1121580	1124706	1300167
7		16	80	26	10	1120624	1121581	1124715	1122919
8		19	88	28	10	1120625	1121582	1124733	1122921
	9	19	88	28	10	1120626	1121583	1124742	1122923
10		22	95	31	10	1120627	1121584	1124751	1122925
	11	22	102	34	12	1120628	1121586	1124760	1300168
12		26	110	38	12	1120629	1121587	1124779	1122927
14		26	110	38	12	1120630	1121588	1124797	1122929
	15	26	110	38	12	1120631	1121589	1124804	1300170
16		32	123	44	16	1120632	1121590	1124813	1122941
18		32	123	44	16	1120633	1121591	1124831	1122943
20		38	135	54	16	-	-	1124038	1122945
20		38	141	54	20	1120634	1121592	1124859	1300171
22		38	141	54	20	1120635	1121593	1124868	1122947
25		45	166	65	25	1120636	1121595	1124886	1122949
	30	45	166	65	25	1120637	1121596	1124911	1122951
32		53	186	73	32	1120638	1121597	1124920	1122953

Schnittwertempfehlungen ab Seite 466
 Cutting data recommendations starting page 466

stirnseitig bis Mitte schneidend
NC-gerecht

center cutting
suitable for NC

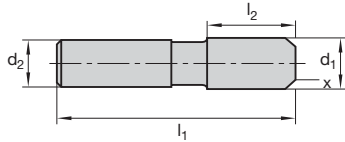

Katalog-Nr.	Cat.-No.	1441
Typ	Type	N
Norm	Standard	Werknorm Fette Standard
Drallwinkel	Helix angle	≈ 25 ... 32° ²⁾
Zylinderschaft	Straight shank	Werknorm Fette Standard
Beschichtung	Coating	-
Werkstoff	Material	HSS-E 909 M 42

d, e 8 ¹⁾	l ₂	l ₁	d ₂ h 6	x	Ident No.
2,8	10	52	6	-	1118713
3	10	52	6	0,15	1118722
3,8	11	55	6	0,15	1118731
4	11	55	6	0,15	1118740
4,8	15	57	6	0,15	1118759
5	15	57	6	0,15	1118768
5,75	16	57	6	0,2	1118777
6	16	57	6	0,2	1118786
6,75	18	62	8	0,2	1118795
7	18	62	8	0,2	1118802
7,75	20	62	8	0,3	1118811
8	20	62	8	0,3	1118820
8,7	24	72	10	0,3	1118839
9	24	72	10	0,3	1118848
9,7	25	72	10	0,3	1118857
10	25	72	10	0,3	1118866
10,7	26	83	12	0,3	1118875
11	26	83	12	0,3	1118884
11,7	27	83	12	0,3	1118893
12	27	83	12	0,3	1118900
13,7	28	83	12	0,3	1118928
14	28	83	12	0,3	1118937
14,7	34	98	16	0,3	1118946
15	34	98	16	0,3	1118955
15,7	36	98	16	0,3	1118964
16	36	98	16	0,3	1118973
18	38	98	16	0,3	1119008
20	44	108	20	0,4	1119026
22	50	116	20	0,4	1119044
25	52	128	25	0,4	1119080
28	56	128	25	0,4	1119124
30	68	139	25	0,4	1119133
32	68	139	25	0,5	1119151

¹⁾ Toleranz für Vollmaß = e8
Toleranz für Untermaß = - 0,1 mm für Ø 1,8 bis 4,8 mm; - 0,05 mm für Ø 5,75 bis 15,7 mm.

¹⁾ Tolerance for Full Size = e8
Tolerance for Undersize = - 0,1 mm for Ø 1,8 to 4,8 mm; - 0,05 mm for Ø 5,75 to 15,7 mm.

²⁾ Drallsteigung ausgelegt auch für Schleifeinrichtung System Hurth

²⁾ Spiral identified for grinding equipment System Hurth

Schnittwertempfehlungen ab Seite 466

Cutting data recommendations starting page 466

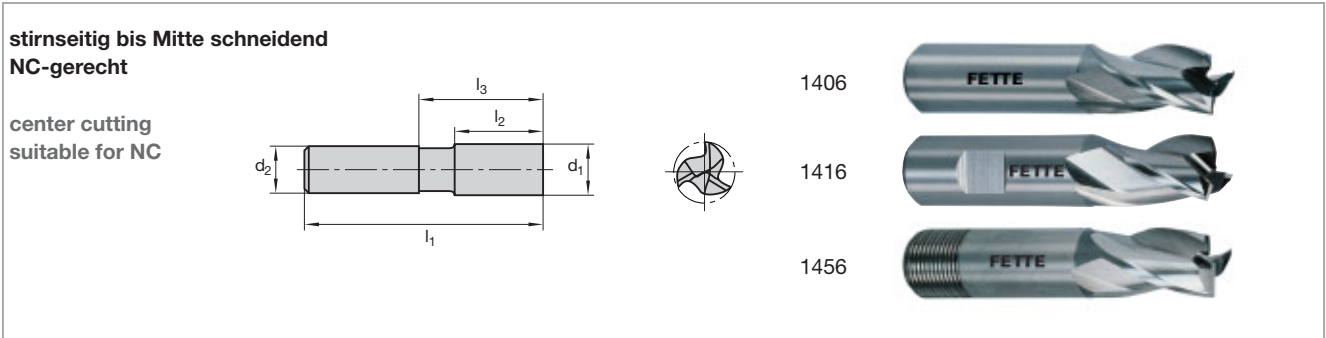

Katalog-Nr.	Cat.-No.	1406	1406 C	1416	1416 C	1456	1456 C
Typ	Type	N					
Norm	Standard	DIN 327 B		DIN 327 D		DIN 327 H	
Drallwinkel	Helix angle	≈ 30°					
Zylinderschaft	Straight shank	DIN 1835 A		DIN 1835 B		DIN 1835 D	
Beschichtung	Coating	-	TiCN Plus	-	TiCN Plus	-	TiCN Plus
Werkstoff	Material	HSS-E 909 M 42					

d, e 8	d, h 10	l ₂	l ₁	l ₃	d ₂ h 6	Ident No.	Ident No.	Ident No.	Ident No.	Ident No.	Ident No.
2	1,8	4	48	12	6	1120419	1120377	1120441	1120453	1120470	1120478
		4	48	12	6	1120420	1120378	1120442	1120454	1120471	1120479
3		5	49	13	6	1110622	1120379	1111079	1111179	1126125	1126508
	3,5	6	50	14	6	1120421	1120380	1120443	1120455	1120472	1120480
	3,8	7	51	15	6	1110631	1120381	1110633	1111181	1126134	1120481
4		7	51	15	6	1110640	1120382	1111088	1111183	1126143	1126517
	4,5	7	51	15	6	1120422	1120383	1120444	1120456	1120473	1120482
5		8	52	16	6	1110668	1120384	1111097	1111187	1126161	1126526
	5,5	8	52	16	6	1120423	1120385	1120445	1120457	1120474	1120483
6		8	52	16	6	1110686	1120386	1111104	1111191	1126189	1126535
	6,5	10	60	20	10	1120424	1120387	1120446	1120458	1120475	1120484
7		10	60	20	10	1110702	1120388	1110704	1111195	1126205	1126539
	7,5	10	60	20	10	1120425	1120389	1120447	1120459	1120476	1120485
8		11	61	21	10	1110720	1120390	1111113	1111199	1126223	1126544
9		11	61	21	10	1120426	1120391	1120448	1120460	1126401	1120486
	9,5	11	61	21	10	1120427	1120392	1120449	1120461	1120477	1120487
10		13	63	23	10	1110748	1120393	1111122	1111203	1126241	1126553
11		13	70	25	12	1120428	1120394	1120450	1120462	1126410	1120488
12		16	73	28	12	1110766	1120395	1111131	1111207	1126269	1126562
13		16	73	28	12	1120429	1120396	1120451	1120463	1126429	1120489
14		16	73	28	12	1110784	1120397	1111140	1111213	1126287	1120490
15		16	73	28	12	1120430	1120398	1120452	1120464	1126438	1120491
16		19	79	31	16	1110800	1120399	1111159	1111217	1126303	1126580
18		19	79	31	16	1110819	1120400	1111168	1111219	1126312	1120492
20		22	82	38	16	-	-	-	-	1126387	-
20		22	88	38	20	1110828	1120401	1111177	1111221	1126321	1126606
22		22	88	38	20	1110837	1120402	1110839	1120465	1126330	1120493
25		26	102	46	25	1110855	1120403	1110857	1111227	1126358	1120494
28		26	102	46	25	1110864	1120404	1110866	1120466	1126367	1120495
30		26	102	46	25	1110873	1120431	1110875	1120467	1126376	1120496
32		32	112	52	32	1110882	1120432	1110884	1120468	1126385	1120497

Tri-Cut-Bohrnutenfräser aus HSS-E-PM siehe Kat.-Nr. F 406, F 416, Seite 371
Tri-Cut-Slot Drills of HSS-E-PM see Cat.-No. F 406 C, F 416 C, Page 371

Schnittwertempfehlungen ab Seite 466
Cutting data recommendations starting page 466

Tri-Cut Bohrnutenfräser, Dreischneider, lang Tri-Cut Slot Drills, 3-Flute, long

stirnseitig bis Mitte schneidend
NC-gerecht

center cutting
suitable for NC

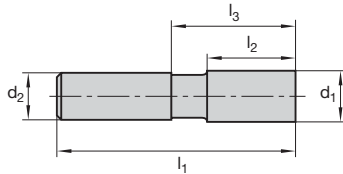

1406



1416



1456



Katalog-Nr.	Cat.-No.	1406	1406 C	1416	1416 C	1456	1456 C
Typ	Type	N					
Norm	Standard	≈ DIN 844 A		≈ DIN 844 B		≈ DIN 844 D	
Drallwinkel	Helix angle	≈ 30°					
Zylinderschaft	Straight shank	DIN 1835 A		DIN 1835 B		DIN 1835 D	
Beschichtung	Coating	-	TiCN Plus	-	TiCN Plus	-	TiCN Plus
Werkstoff	Material	HSS-E 909 M 42					

d ₁ e 8	l ₂	l ₁	l ₃	d ₂ h 6	Ident No.	Ident No.	Ident No.	Ident No.	Ident No.	Ident No.
3	8	52	16	6	1111220	1120433	1111499	1111613	1126722	1120405
4	11	55	19	6	1111248	1120434	1111505	1111615	1126740	1120406
5	13	57	21	6	1111266	1120435	1111514	1111617	1126768	1120407
6	13	57	21	6	1111284	1120436	1111523	1111619	1126786	1120408
7	16	66	26	10	1111300	1120437	1111527	1111539	1126802	1120409
8	19	69	28	10	1111328	1120438	1111532	1111621	1126820	1120410
10	22	72	31	10	1111346	1120439	1111541	1111623	1126848	1120411
12	26	83	38	12	1111364	1120440	1111550	1111625	1126866	1120412
14	26	83	38	12	1111382	1120371	1111569	1111627	1126884	1120413
16	32	92	44	16	1111408	1120372	1111578	1111629	1126900	1120414
18	32	92	44	16	1111417	1120373	1111587	1111631	1126919	1120415
20	38	98	54	16	-	-	-	-	1126984	-
20	38	104	54	20	1111426	1120374	1111596	1111633	1126928	1120416
22	38	104	54	20	1111435	1120375	1111599	1120469	1126937	1120417
25	45	121	65	25	1111453	1120376	1111603	1111573	1126955	1120418

stirnseitig bis Mitte schneidend
 NC-gerecht

center cutting
 suitable for NC

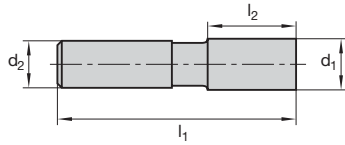

Katalog-Nr.	Cat.-No.	1409	1409 C
Typ	Type	N	
Norm	Standard	Werknorm Fette Standard	
Drallwinkel	Helix angle	≈ 30°	
Zylinderschaft	Straight shank	Werknorm ¹⁾ Fette Standard	
Beschichtung	Coating	-	TiCN Plus
Werkstoff	Material	HSS-E EMo5Co5	

d ₁ e 8	d ₁ h 10	l ₂	l ₁	d ₂ h 6	Ident No.	Ident No.
	1	2,5	24,5	6	1112586	1300289
	1,5	2,5	24,5	6	1112595	1300290
2		3	26	6	1112611	1300291
2,5		4	25,5	6	1112602	1300292
	2,8	4,5	28	6	1112620	1300293
3		4,5	28	6	1112639	1300294
	3,5	5,5	30	6	1112648	1300296
	3,8	6	32,5	6	1112657	1300297
4		6	32,5	6	1112666	1300298
	4,8	8	36	6	1112675	1300299
5		8	36	6	1112684	1300300
	5,75	9,5	36	6	1112693	1300302
6		9,5	36	6	1112700	1300303

¹⁾ Mini-Adapter und Spannfutter auf Anfrage
¹⁾ Mini-Adapter and chucks upon request

Schnittwertempfehlungen ab Seite 466
 Cutting data recommendations starting page 466

Mini-Tri-Cut Bohrnutenfräser, Dreischneider, lang Mini-Tri-Cut Slot Drills, 3-Flute, long

stirnseitig bis Mitte schneidend
NC-gerecht

center cutting
suitable for NC

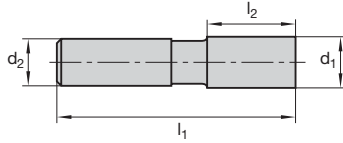

Katalog-Nr.	Cat.-No.	1409	1409 C
Typ	Type	N	
Norm	Standard	Werknorm Fette Standard	
Drallwinkel	Helix angle	≈ 30°	
Zylinderschaft	Straight shank	Werknorm ¹⁾ Fette Standard	
Beschichtung	Coating	-	TiCN Plus
Werkstoff	Material	HSS-E EMo5Co5	

d ₁ e 8	d ₁ h 10	l ₂	l ₁	d ₂ h 6	Ident No.	Ident No.
2		4,5	29	6	1112782	1300304
2,5		6,5	32	6	1112791	1300305
3		7,5	34	6	1112808	1300306
	3,5	8,5	36,5	6	1112817	1300307
4		9,5	39	6	1112826	1300308
	4,5	11	42	6	1112835	1300309
5		12,5	44,5	6	1112844	1300311
	5,5	14,5	46	6	1112853	1300312
	6	16	48	6	1112862	1300313

¹⁾ Mini-Adapter und Spannfutter auf Anfrage
¹⁾ Mini-Adapter and chucks upon request

Schnittwertempfehlungen ab Seite 466
Cutting data recommendations starting page 466

stirnseitig bis Mitte schneidend
für Tiefräsoperationen
NC-gerecht

center cutting
 for deep milling
 operations
 suitable for NC

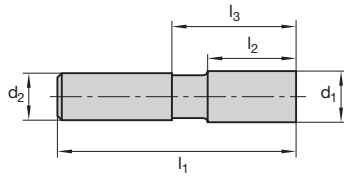

Katalog-Nr.	Cat.-No.	1459
Typ	Type	N
Norm	Standard	Werknorm Fette Standard
Drallwinkel	Helix angle	≈ 30°
Zylinderschaft	Straight shank	DIN 1835 B / D
Beschichtung	Coating	-
Werkstoff	Material	HSS-E 909 M 42

d ₁ k 10	l ₂	l ₁	l ₃	d ₂ h 6	Ident No.
10	50	160	120	10	1127204
12	50	160	115	12	1127213
16	70	200	152	16	1127231
20	70	200	150	20	1127240
25	70	200	144	25	1127259

Schnittwertempfehlungen ab Seite 466
 Cutting data recommendations starting page 466

stirnseitig bis Mitte schneidend
NC-gerecht

center cutting
suitable for NC

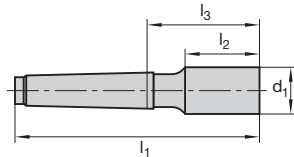

Katalog-Nr.	Cat.-No.	1432
Typ	Type	N
Norm	Standard	DIN 326 D
Drallwinkel	Helix angle	≈ 30°
Morsekegel	Morse taper shank	DIN 228
Beschichtung	Coating	-
Werkstoff	Material	HSS-E EMo5Co5

d ₁ e 8/h 10	l ₂	l ₁	l ₃	MK	Ident No.
14	16	101	37	2	1116822
16	19	104	40	2	1116831
18	19	104	40	2	1116840
20	22	107	43	2	1116859
22	22	107	43	2	1116868
24	26	128	47	3	1116877
25	26	128	47	3	1116886
28	26	128	47	3	1116895
30 ¹⁾	26	128	47	3	1116902
32	32	157	72,5	4	1116911
36	32	157	72,5	4	1116920
40	38	163	78,5	4	1116939
45	38	163	78,5	4	1116948
50	45	203	107,5	5	1116957

¹⁾ Toleranz = h 10
¹⁾ Tolerance = h 10

Schnittwertempfehlungen ab Seite 466
Cutting data recommendations starting page 466

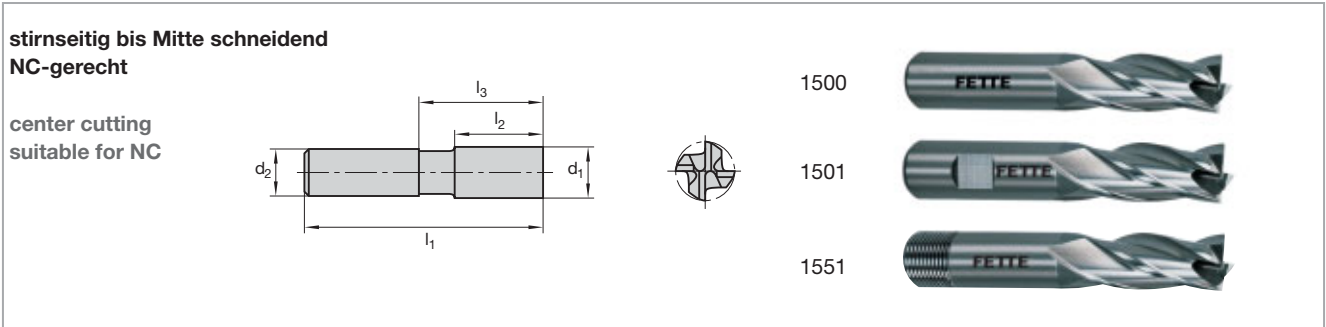

Katalog-Nr.	Cat.-No.	1500	1500 C	1501	1501 C	1551	1551 C
Typ	Type	N					
Norm	Standard	DIN 844 A		DIN 844 B		DIN 844 D	
Drallwinkel	Helix angle	≈ 30°					
Zylinderschaft	Straight shank	DIN 1835 A		DIN 1835 B		DIN 1835 D	
Beschichtung	Coating	-	TiCN Plus	-	TiCN Plus	-	TiCN Plus
Werkstoff	Material	HSS-E 909 M 42					

d ₁ k 10	l ₂	l ₁	l ₃	d ₂ h 6	z	Ident No.	Ident No.	Ident No.	Ident No.	Ident No.	Ident No.
2	7	51	15	6	4	1130913	1120899	1132700	1120941	1120970	1120973
2,5	8	52	16	6	4	1130922	1120900	1132702	1120942	1120971	1120974
3	8	52	16	6	4	1130931	1120901	1132704	1120943	1158215	1158011
4	11	55	19	6	4	1130959	1120902	1132708	1120944	1158233	1158013
5	13	57	21	6	4	1130977	1120903	1132712	1120945	1158251	1158015
6	13	57	21	6	4	1130995	1120904	1132430	1132557	1158279	1158017
7	16	66	26	10	4	1131011	1120905	1132720	1120946	1158297	1158018
8	19	69	28	10	4	1131039	1120906	1132449	1132559	1158313	1158019
9	19	69	28	10	4	1131057	1120907	1132728	1120947	1158331	1158026
10	22	72	31	10	4	1131075	1120908	1132458	1132561	1158359	1158028
11	22	79	34	12	4	1131093	1120909	1132734	1120948	1158377	1158035
12	26	83	38	12	4	1131119	1120910	1132467	1132563	1158395	1158037
13	26	83	38	12	4	1131128	1120911	1132738	1120949	1158402	1158044
14	26	83	38	12	4	1131137	1120912	1132476	1132565	1158411	1158046
15	26	83	38	12	4	1131146	1120913	1132742	1120950	1158420	1158053
16	32	92	44	16	4	1131155	1120914	1132485	1132567	1158439	1158055
17	32	92	44	16	4	1131164	1120915	1132746	1120951	1158448	1120975
18	32	92	44	16	4	1131173	1120916	1132494	1132569	1158457	1158064
20	38	98	54	16	4	-	-	-	-	1158643	1158071
20	38	104	54	20	4	1131191	1120917	1132500	1132571	1158475	1158073
22	38	104	54	20	5	1131217	1120918	1132519	1132573	1158484	1158082
24	45	121	65	25	5	1131235	1120919	1132528	1132575	1158493	1120976
25	45	121	65	25	5	1131244	1120920	1132537	1132577	1158509	1158091
28	45	121	65	25	5	1131271	1120921	1132546	1132579	1158527	1158108
30	45	121	65	25	5	1131299	1120922	1132555	1132581	1158536	1158117
32	53	133	73	32	6	1131306	1120923	1132564	1120952	1158545	1158126

stirnseitig bis Mitte schneidend
NC-gerecht

center cutting
suitable for NC

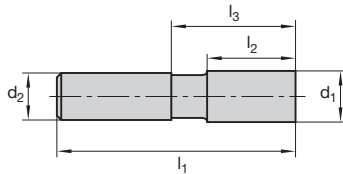

1500



1501



1551



Katalog-Nr.	Cat.-No.	1500	1500 C	1501	1501 C	1551	1551 C
Typ	Type	N					
Norm	Standard	DIN 844 A		DIN 844 B		DIN 844 D	
Drallwinkel	Helix angle	≈ 30°					
Zylinderschaft	Straight shank	DIN 1835 A		DIN 1835 B		DIN 1835 D	
Beschichtung	Coating	-	TiCN Plus	-	TiCN Plus	-	TiCN Plus
Werkstoff	Material	HSS-E 909 M 42					

d ₁ k 10	l ₂	l ₁	l ₃	d ₂ h 6	z	Ident No.	Ident No.	Ident No.	Ident No.	Ident No.	Ident No.
4	19	63	27	6	4	1120982	1120924	1121104	1120953	1159036	1160704
5	24	68	32	6	4	1120983	1120925	1121105	1120954	1159054	1160706
6	24	68	32	6	4	1120984	1120926	1121106	1120955	1159072	1160708
7	30	80	40	10	4	1120985	1120927	1121107	1120956	1159090	1120977
8	38	88	47	10	4	1120986	1120928	1121108	1120957	1159116	1160710
9	38	88	47	10	4	1120987	1120929	1121109	1120958	1159125	1120978
10	45	95	57	10	4	1120988	1120930	1121110	1120959	1159134	1160729
11	45	102	57	12	4	1120989	1120931	1121111	1120960	1159143	1120979
12	53	110	65	12	4	1120990	1120932	1121112	1120961	1159152	1160738
14	53	110	65	12	4	1120991	1120933	1121113	1120962	1159170	1160747
16	63	123	75	16	4	1120992	1120934	1121114	1120963	1159198	1160756
18	63	123	75	16	4	1120993	1120935	1121115	1120964	1159214	1160765
20	75	135	91	16	4	-	-	-	-	1159973	1160772
20	75	141	91	20	4	1120994	1120936	1121116	1120965	1159232	1160774
25	90	166	110	25	5	1120995	1120937	1121117	1120966	1159269	1160792
30	90	166	110	25	5	1120996	1120938	1121118	1120967	1159296	1160818
32	106	186	126	32	6	1120997	1120939	1121119	1120968	1159303	1160827
40	125	205	147	32	6	-	-	-	-	1159358	1160831
40	125	217	147	40	6	1120998	1120940	1121120	1120969	-	-

stirnseitig bis Mitte schneidend
NC-gerecht

center cutting
suitable for NC

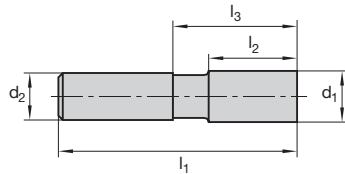

1503



1523



Katalog-Nr.	Cat.-No.	1503	1503 C	1523	1523 C
Typ	Type	SN			
Norm	Standard	DIN 844 A		DIN 844 B	
Drallwinkel	Helix angle	≈ 40°			
Zylinderschaft	Straight shank	DIN 1835 A		DIN 1835 B	
Beschichtung	Coating	-	TiCN Plus	-	TiCN Plus
Werkstoff	Material	HSS-E 909 M 42			

d ₁ k 10	l ₂	l ₁	l ₃	d ₂ h 6	z	Ident No.	Ident No.	Ident No.	Ident No.
2	7	51	15	6	4	1120999	1121002	1121058	1121066
3	8	52	16	6	4	1135712	1121003	1121059	1121067
4	11	55	19	6	4	1135721	1121021	1136301	1134003
5	13	57	21	6	4	1135730	1121023	1136310	1134005
6	13	57	21	6	4	1135749	1121024	1136329	1134007
7	16	66	26	10	4	1121000	1121025	1121060	1121068
8	19	69	28	10	4	1135767	1121026	1136338	1134009
10	22	72	31	10	4	1135785	1121027	1136347	1134018
12	26	83	38	12	4	1135801	1121028	1136356	1134027
14	26	83	38	12	4	1135829	1121029	1136365	1134036
16	32	92	44	16	4	1135847	1121030	1136374	1134045
18	32	92	44	16	4	1135865	1121031	1136383	1134054
20	38	104	54	20	4	1135883	1121032	1136392	1134063
22	38	104	54	20	5	1135909	1121033	1136409	1134072
24	45	121	65	25	5	1135927	1121034	1121061	1121069
25	45	121	65	25	6	1135936	1121035	1136418	1134081
28	45	121	65	25	6	1135954	1121036	1136427	1134090
30	45	121	65	25	6	1135972	1121037	1136436	1134107
32	53	133	73	32	6	1135981	1121038	1136445	1134116

stirnseitig bis Mitte schneidend
NC-gerecht

center cutting
suitable for NC

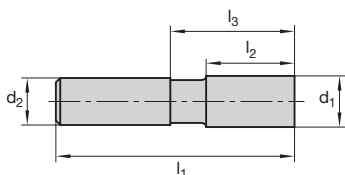

1503



1523



Katalog-Nr.	Cat.-No.	1503	1503 C	1523	1523 C
Typ	Type	SN			
Norm	Standard	DIN 844 A		DIN 844 B	
Drallwinkel	Helix angle	≈ 40°			
Zylinderschaft	Straight shank	DIN 1835 A		DIN 1835 B	
Beschichtung	Coating	-	TiCN Plus	-	TiCN Plus
Werkstoff	Material	HSS-E 909 M 42			

d ₁ k 10	l ₂	l ₁	l ₃	d ₂ h 6	z	Ident No.	Ident No.	Ident No.	Ident No.
3	12	56	20	6	4	1136034	1121039	1121062	1121070
4	19	63	27	6	4	1136043	1121040	1137505	1134155
5	24	68	32	6	4	1136052	1121041	1137514	1134157
6	24	68	32	6	4	1136061	1121042	1137523	1134159
7	30	80	40	10	4	1121001	1121043	1121063	1121071
8	38	88	47	10	4	1136070	1121044	1137532	1134161
10	45	95	57	10	4	1136098	1121045	1137541	1134170
12	53	110	65	12	4	1136105	1121046	1137550	1134189
14	53	110	65	12	4	1136114	1121047	1137569	1134198
15	53	110	65	12	4	1136123	1121048	1121064	1121072
16	63	123	75	16	4	1136132	1121049	1137578	1134205
18	63	123	75	16	4	1136141	1121050	1137587	1134214
20	75	141	91	20	4	1136150	1121051	1137596	1134223
22	75	141	91	20	5	1136169	1121052	1137603	1134232
24	90	166	110	25	5	1136178	1121053	1121065	1121073
25	90	166	110	25	6	1136187	1121054	1137612	1134241
28	90	166	110	25	6	1136203	1121055	1137621	1134250
30	90	166	110	25	6	1136212	1121056	1137630	1134269
32	106	186	126	32	6	1136221	1121057	1137649	1134278

stirnseitig bis Mitte schneidend
NC-gerecht

center cutting
 suitable for NC

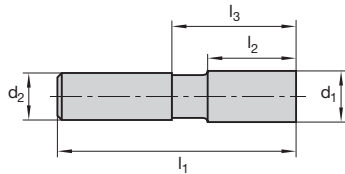

1573



1513



Katalog-Nr.	Cat.-No.	1573	1573 C	1513	1513 C
Typ	Type			SN 50	
Norm	Standard	DIN 327 B		DIN 327 D	
Drallwinkel	Helix angle	≈ 50°			
Zylinderschaft	Straight shank	DIN 1835 A		DIN 1835 B	
Beschichtung	Coating	-	TiCN Plus	-	TiCN Plus
Werkstoff	Material	HSS-E 909 M 42			

d ₁ k 10	l ₂	l ₁	l ₃	d ₂ h 6	z	Ident No.	Ident No.	Ident No.	Ident No.
6	8	52	16	6	3	1121307	1121284	1136421	1136441
8	11	61	21	10	3	1121308	1121285	1136423	1136443
10	13	63	23	10	3	1121309	1121286	1136425	1136447
12	16	73	28	12	4	1121310	1121287	1136429	1136449
16	19	79	31	16	4	1121311	1121288	1136431	1136451
20	22	88	38	20	4	1121312	1121289	1136433	1136453
25	26	102	46	25	4	1121313	1121290	1136435	1136455
30	26	102	46	25	6	1121314	1121291	1136437	1136457
32	32	112	52	32	6	1121315	1121292	1136439	1136459

stirnseitig bis Mitte schneidend
NC-gerecht

center cutting
suitable for NC

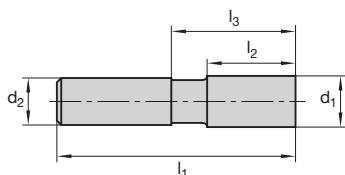

1573



1513



Katalog-Nr.	Cat.-No.	1573	1573 C	1513	1513 C
Typ	Type	SN 50			
Norm	Standard	DIN 844 A		DIN 844 B	
Drallwinkel	Helix angle	≈ 50°			
Zylinderschaft	Straight shank	DIN 1835 A		DIN 1835 B	
Beschichtung	Coating	-	TiCN Plus	-	TiCN Plus
Werkstoff	Material	HSS-E 909 M 42			

d ₁ k 10	l ₂	l ₁	l ₃	d ₂ h 6	z	Ident No.	Ident No.	Ident No.	Ident No.
6	13	57	21	6	3	1121316	1121293	1136420	1136438
8	19	69	28	10	3	1121317	1121294	1136422	1136440
10	22	72	31	10	3	1121318	1121295	1136424	1136442
12	26	83	38	12	4	1121319	1121296	1136426	1136444
16	32	92	44	16	4	1121320	1121297	1136428	1136448
20	38	104	54	20	4	1121321	1121298	1136430	1136450
25	45	121	65	25	4	1121322	1121299	1136432	1136452
32	53	133	73	32	6	1121323	1121300	1136434	1136456

stirnseitig bis Mitte schneidend
 NC-gerecht
 hinterschliffen

center cutting
 suitable for NC
 relief ground

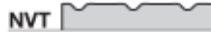
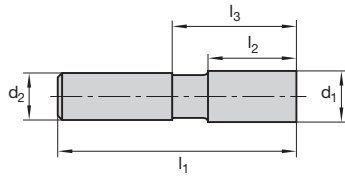

Katalog-Nr.	Cat.-No.	1519	1519 C
Typ	Type	NVT	
Norm	Standard	DIN 844 B	
Drallwinkel	Helix angle	≈ 25°	
Zylinderschaft	Straight shank	DIN 1835 B	
Beschichtung	Coating	-	TiCN Plus
Werkstoff	Material	HSS-E 909 M 42	

d ₁ k 10	l ₂	l ₁	l ₃	d ₂ h 6	z	Ident No.	Ident No.
10	22	72	31	10	4	1147629	1147754
12	26	83	38	12	4	1147638	1147763
14	26	83	38	12	4	1147647	1147772
16	32	92	44	16	4	1147656	1147781
18	32	92	44	16	4	1147665	1147790
20	38	104	54	20	4	1147674	1147807
25	45	121	65	25	6	1147692	1147825

Schnittwertempfehlungen ab Seite 466
 Cutting data recommendations starting page 466

stirnseitig bis Mitte schneidend
NC-gerecht

center cutting
suitable for NC

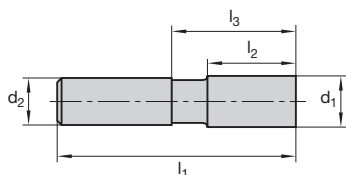

Katalog-Nr.	Cat.-No.	1514	1514 C
Typ	Type	W	
Norm	Standard	DIN 844 B	
Drallwinkel	Helix angle	≈ 40°	
Zylinderschaft	Straight shank	DIN 1835 B	
Beschichtung	Coating	-	TiCN Plus
Werkstoff	Material	HSS-E 909 M 42	

d ₁ k 10	l ₂	l ₁	l ₃	d ₂ h 6	z	Ident No.	Ident No.
4	11	55	19	6	2	1137701	1137909
5	13	57	21	6	2	1137710	1137911
6	13	57	21	6	2	1137729	1137913
8	19	69	28	10	2	1137738	1137915
10	22	72	31	10	2	1137747	1137917
12	26	83	38	12	2	1137756	1137919
14	26	83	38	12	3	1137765	1137921
16	32	92	44	16	3	1137774	1137923
20	38	104	54	20	3	1137783	1137925
25	45	121	65	25	3	1137792	1137927
30	45	121	65	25	3	1137809	1137929
32	53	133	73	32	3	1137818	1137931

Schnittwertempfehlungen ab Seite 466
Cutting data recommendations starting page 466



stirnseitig bis Mitte schneidend
NC-gerecht

center cutting
suitable for NC

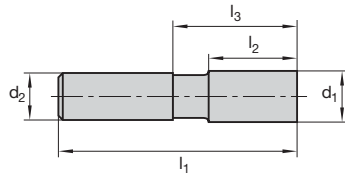

Katalog-Nr.	Cat.-No.	1514	1514 C
Typ	Type	W	
Norm	Standard	DIN 844 B	
Drallwinkel	Helix angle	≈ 40°	
Zylinderschaft	Straight shank	DIN 1835 B	
Beschichtung	Coating	-	TiCN Plus
Werkstoff	Material	HSS-E 909 M 42	

d ₁ k 10	l ₂	l ₁	l ₃	d ₂ h 6	z	Ident No.	Ident No.
6	24	68	32	6	2	1137827	1137933
8	38	88	47	10	2	1137836	1137935
10	45	95	57	10	2	1137845	1137937
12	52	110	65	12	2	1137854	1137939
16	63	123	75	16	3	1137863	1137941
20	75	141	91	20	3	1137872	1137943
25	90	166	110	25	3	1137881	1137945
30	90	166	110	25	3	1137890	1137947
32	106	186	126	32	3	1137907	1137949

Schnittwertempfehlungen ab Seite 466
Cutting data recommendations starting page 466

NC-gerecht
suitable for NC

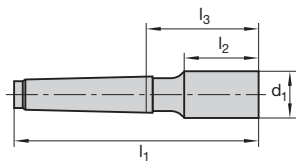

Katalog-Nr.	Cat.-No.	1530
Typ	Type	N
Norm	Standard	DIN 845 B + C ¹⁾
Drallwinkel	Helix angle	≈ 30°
Morsekegel	Morse taper shank	DIN 228 A / DIN 2207
Beschichtung	Coating	-
Werkstoff	Material	HSS-E 909 M 42

d ₁ k 10	l ₂	l ₁	l ₃	MK	z	Ident No.
6	13	83	29,5	1	4	1145211
8	19	89	35,5	1	4	1145239
10	22	92	38,5	1	4	1145257
15	26	111	47	2	4	1145300
16	32	117	53	2	4	1145319
18	32	117	53	2	4	1145337
20	38	123	59	2	4	1145355
22	38	123	59	2	6	1145373
24	45	147	66	3	6	1145391
25	45	147	66	3	6	1145408
26	45	147	66	3	6	1145417
28	45	147	66	3	6	1145435
30	45	147	66	3	6	1145453
32	53	201	103,5	4	6	1145462
36	53	201	103,5	4	6	1145505
40	63	211	113,5	4	6	1145523
45	63	211	113,5	4	8	1145550
50	75	261	137,5	5	8	1145587
63	90	276	152,5	5	8	1145612

¹⁾ DIN 845 Form B bis MK 3 - DIN 845 Form C ab MK 4

¹⁾ DIN 845 Form B up to morse taper No. 3 - DIN 845 Form C starting at morse taper No. 4

Schnittwertempfehlungen ab Seite 466

Cutting data recommendations starting page 466



NC-gerecht
suitable for NC



Katalog-Nr.	Cat.-No.	1530
Typ	Type	N
Norm	Standard	DIN 845 B + C ¹⁾
Drallwinkel	Helix angle	≈ 30°
Morsekegel	Morse taper shank	DIN 228 A / DIN 2207
Beschichtung	Coating	-
Werkstoff	Material	HSS-E 909 M 42

d ₁ k 10	l ₂	l ₁	l ₃	MK	z	Ident No.
16	63	148	84	2	4	1149244
18	63	148	84	2	4	1149253
20	75	160	96	2	4	1149262
20	75	177	96	3	4	1148833
22	75	160	96	2	6	1149271
22	90	192	111	3	6	1148842
25	90	192	111	3	6	1148851
28	90	192	111	3	6	1149280
28	112	265	162,5	4	6	1148860
30	90	192	111	3	6	1149299
30	112	265	162,5	4	6	1148879
32	106	254	156,5	4	6	1148888
36	106	254	156,5	4	6	1148897
36	125	273	175,5	4	6	1148904
40	125	273	175,5	4	6	1149306
40	160	352	222,5	5	6	1148931
45	160	352	222,5	5	8	1148968

¹⁾ DIN 845 Form B bis MK 3 - DIN 845 Form C ab MK 4

¹⁾ DIN 845 Form B up to morse taper No. 3 - DIN 845 Form C starting at morse taper No. 4

Schnittwertempfehlungen ab Seite 466

Cutting data recommendations starting page 466

stirnseitig bis Mitte schneidend
NC-gerecht

center cutting
suitable for NC

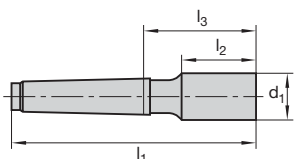

Katalog-Nr.	Cat.-No.	1531
Typ	Type	N
Norm	Standard	DIN 845 B + C ¹⁾
Drallwinkel	Helix angle	≈ 30°
Morsekegel	Morse taper shank	DIN 228 A / DIN 2207
Beschichtung	Coating	-
Werkstoff	Material	HSS-E 909 M 42

d ₁ k 10	l ₂	l ₁	l ₃	MK	z	Ident No.
16	32	117	53	2	4	1146862
18	32	117	53	2	4	1146871
20	38	123	59	2	4	1146880
22	38	123	59	2	6	1146899
24	45	147	66	3	6	1146906
25	45	147	66	3	6	1146915
28	45	147	66	3	6	1146924
30	45	147	66	3	6	1146933
32	53	201	103,5	4	6	1146942
36	53	201	103,5	4	6	1146951
40	63	211	113,5	4	6	1146960

¹⁾ DIN 845 Form B bis MK 3 - DIN 845 Form C ab MK 4

¹⁾ DIN 845 Form B up to morse taper No. 3 - DIN 845 Form C starting at morse taper No. 4

Schnittwertempfehlungen ab Seite 466

Cutting data recommendations starting page 466

NC-gerecht
suitable for NC

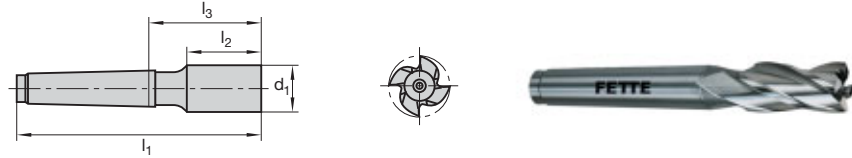

Katalog-Nr.	Cat.-No.	1533
Typ	Type	SN
Norm	Standard	DIN 845 B + C ¹⁾
Drallwinkel	Helix angle	≈ 40°
Morsekegel	Morse taper shank	DIN 228 A / DIN 2207
Beschichtung	Coating	-
Werkstoff	Material	HSS-E 909 M 42

d ₁ k 10	l ₂	l ₁	l ₃	MK	z	Ident No.
12	26	96	52,5	1	4	1145685
16	32	117	53	2	4	1145729
20	38	123	59	2	4	1145765
25	45	147	66	3	6	1145818
28	45	147	66	3	6	1145845
30	45	147	66	3	6	1145863
32	53	155	74	3	6	1145621
32	53	201	103,5	4	6	1145872
36	53	201	103,5	4	6	1145916
40	63	211	103,5	4	6	1145934
45	63	211	103,5	4	8	1145961
50	75	261	137,5	5	8	1145998

¹⁾ DIN 845 Form B bis MK 3 - DIN 845 Form C ab MK 4

¹⁾ DIN 845 Form B up to morse taper No. 3 - DIN 845 Form C starting at morse taper No. 4

Schnittwertempfehlungen ab Seite 466

Cutting data recommendations starting page 466

stirnseitig bis Mitte schneidend
NC-gerecht

center cutting
suitable for NC

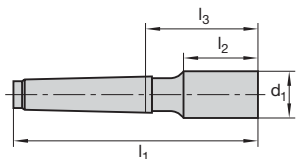

Katalog-Nr.	Cat.-No.	1534
Typ	Type	W
Norm	Standard	DIN 845 B
Drallwinkel	Helix angle	≈ 40°
Morsekegel	Morse taper shank	DIN 228 A
Beschichtung	Coating	-
Werkstoff	Material	HSS-E 909 M 42

d ₁ k 10	l ₂	l ₁	l ₃	MK	z	Ident No.
16	32	117	53	2	3	1150204
20	38	123	59	2	3	1150213
25	45	147	66	3	3	1150231
30	45	147	66	3	3	1150259
40	63	188	113,5	4	4	1150286

Schnittwertempfehlungen ab Seite 466
Cutting data recommendations starting page 466

NC-gerecht
suitable for NC

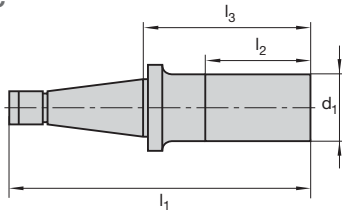

Katalog-Nr.	Cat.-No.	1541
Typ	Type	N
Norm	Standard	DIN 2328
Drallwinkel	Helix angle	≈ 30°
Steilkegel	7/24 Taper	DIN 2080 A
Beschichtung	Coating	-
Werkstoff	Material	HSS-E EMo5Co5

d ₁ k 10	l ₂	l ₁	l ₃	SK	z	Ident No.
32	53	188	94,6	40	6	1155110
36	53	188	94,6	40	6	1155129
40	63	198	104,6	40	6	1155138
45	63	198	104,6	40	8	1155147
50	75	210	116,6	40	8	1155496
50	75	252	125,2	50	8	1155174
56	75	252	125,2	50	8	1155183
63	90	267	140,2	50	8	1155192
80	106	283	156,2	50	10	1155511

Schnittwertempfehlungen ab Seite 466
Cutting data recommendations starting page 466

NC-gerecht
suitable for NC

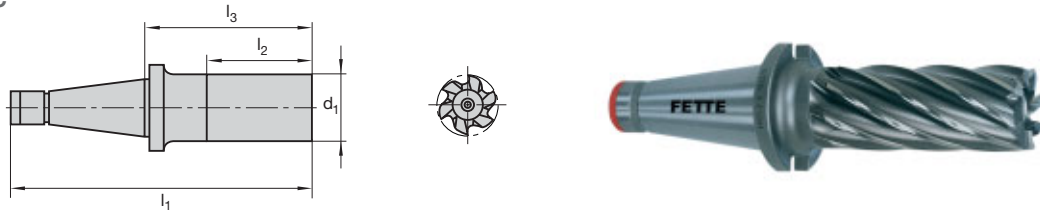

Katalog-Nr.	Cat.-No.	1541
Typ	Type	N
Norm	Standard	DIN 2328
Drallwinkel	Helix angle	≈ 30°
Steilkegel	7/24 Taper	DIN 2080 A
Beschichtung	Coating	-
Werkstoff	Material	HSS-E EMo5Co5

d ₁ k 10	l ₂	l ₁	l ₃	SK	z	Ident No.
32	80	215	121,6	40	6	1155539
32	106	241	147,6	40	6	1155218
36	80	215	121,6	40	6	1155548
36	106	241	147,6	40	6	1155227
40	100	235	141,6	40	6	1155236
40	125	260	166,6	40	6	1155557
45	100	235	141,6	40	8	1155245
45	125	260	166,6	40	8	1155566
50	150	285	191,6	40	8	1155584
50	112	289	162,2	50	8	1155316
50	150	327	200,2	50	8	1155325
50	180	357	230,2	50	8	1155334
56	150	327	200,2	50	8	1155352
56	180	357	230,2	50	8	1155361
63	140	317	190,2	50	8	1155370
63	180	357	230,2	50	8	1155389
63	225	402	275,2	50	8	1155398
80	160	337	210,2	50	10	1155450
80	212	389	262,2	50	10	1155469
80	250	427	300,2	50	10	1155478
80	300	477	350,2	50	10	1155487

Schnittwertempfehlungen ab Seite 466
Cutting data recommendations starting page 466

NC-gerecht
suitable for NC

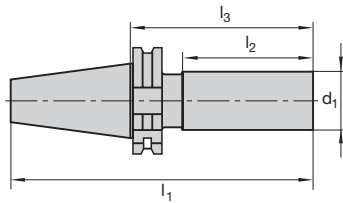

Katalog-Nr.	Cat.-No.	1542
Typ	Type	N
Norm	Standard	≈ DIN 2328
Drallwinkel	Helix angle	≈ 30°
Steilkegel	7/24 Taper	DIN 69871 A
Beschichtung	Coating	-
Werkstoff	Material	HSS-E EMo5Co5

d ₁ k 10	l ₂	l ₁	l ₃	SK	z	Ident No.
32	53	171	102,6	40	6	1155625
36	53	171	102,6	40	6	1155627
40	63	181	112,6	40	6	1155631
50	75	193	124,6	40	8	1155634
50	75	231	129,25	50	8	1155637
63	90	246	144,25	50	8	1155646
80	106	262	160,25	50	10	1155655

Schnittwertempfehlungen ab Seite 466
Cutting data recommendations starting page 466

NC-gerecht
suitable for NC

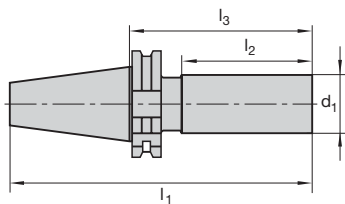

Katalog-Nr.	Cat.-No.	1542
Typ	Type	N
Norm	Standard	≈ DIN 2328
Drallwinkel	Helix angle	≈ 30°
Steilkegel	7/24 Taper	DIN 69871 A
Beschichtung	Coating	-
Werkstoff	Material	HSS-E EMo5Co5

d ₁ k 10	l ₂	l ₁	l ₃	SK	z	Ident No.
32	106	224	155,6	40	6	1155681
40	125	243	174,6	40	6	1155685
50	150	268	199,6	40	8	1155687
40	125	281	179,25	50	6	1155717
40	160	316	214,25	50	6	1155726
50	112	268	166,25	50	8	1155735
50	150	306	204,25	50	8	1155744
50	180	336	234,25	50	8	1155753
63	140	296	194,25	50	8	1155762
63	180	336	234,25	50	8	1155771
63	225	381	279,25	50	8	1155780
80	212	368	266,25	50	10	1155799
80	250	406	304,25	50	10	1155806
80	300	456	304,25	50	10	1155815

Schnittwertempfehlungen ab Seite 466
Cutting data recommendations starting page 466

stirnseitig bis Mitte schneidend
NC-gerecht
hinterschliffen

center cutting
 suitable for NC
 relief ground

1427

1467

1477

Katalog-Nr.	Cat.-No.	1427	1427 C	1467	1467 C	1477	1477 C
Typ	Type	NR					
Norm	Standard	DIN 844 A		DIN 844 B		DIN 844 D	
Drallwinkel	Helix angle	≈ 30°					
Zylinderschaft	Straight shank	DIN 1835 A		DIN 1835 B		DIN 1835 D	
Beschichtung	Coating	-	TiCN Plus	-	TiCN Plus	-	TiCN Plus
Werkstoff	Material	HSS-E EMo5Co5					

d ₁ k 10	l ₂	l ₁	l ₃	d ₂ h 6	Ident No.	Ident No.	Ident No.	Ident No.	Ident No.	Ident No.
6	13	57	21	6	1300606	1300608	1300616	1300617	1300618	1300619
8	19	69	28	10	1300607	1300609	1112305	1112414	1128004	1128299
10	22	72	31	10	1111694	1300610	1112309	1112416	1128007	1128301
12	26	83	38	12	1111701	1300611	1112318	1112425	1128016	1128310
14	26	83	38	12	1111710	1300612	1112327	1112434	1128025	1128329
16	32	92	44	16	1111738	1300613	1112336	1112443	1128043	1128338
18	32	92	44	16	1111747	1300614	1112345	1112452	1128052	1128347
20	38	104	54	20	1111756	1300615	1112354	1112461	1128061	1128356

Tri-Cut-Schafffräser aus HSS-E-PM siehe Kat.-Nr. F 427, F 467, Seite 381
 Tri-Cut-End Mills of HSS-E-PM see Cat.-No. F 427 C, F 467 C, Page 381

Schnittwertempfehlungen ab Seite 466
 Cutting data recommendations starting page 466

stirnseitig bis Mitte schneidend
NC-gerecht
hinterschliffen

center cutting
suitable for NC
relief ground

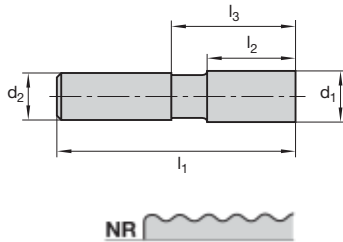

1506



1516



1556



Katalog-Nr.	Cat.-No.	1506	1506 C	1516	1516 C	1556	1556 C
Typ	Type	NR					
Norm	Standard	DIN 844 A		DIN 844 B		DIN 844 D	
Drallwinkel	Helix angle	≈ 30°					
Zylinderschaft	Straight shank	DIN 1835 A		DIN 1835 B		DIN 1835 D	
Beschichtung	Coating	-	TiCN Plus	-	TiCN Plus	-	TiCN Plus
Werkstoff	Material	HSS-E EMo5Co5					

d ₁ k 12	l ₂	l ₁	l ₃	d ₂ h 6	z	Ident No.	Ident No.	Ident No.	Ident No.	Ident No.	Ident No.
6	13	57	21	6	4	1139111	1120498	1141092	1141093	1160319	1162000
7	16	66	26	10	4	1139139	1120499	1120536	1120540	1160328	1162002
8	19	69	28	10	4	1139157	1120500	1141094	1141095	1160337	1162004
9	19	69	28	10	4	1139166	1120501	1120537	1120541	1160346	1162006
10	22	72	31	10	4	1139175	1120502	1141096	1141097	1160355	1162013
11	22	79	34	12	4	1139184	1120503	1120538	1120530	1160364	1162015
12	26	83	38	12	4	1139193	1120504	1141098	1141099	1160373	1162022
14	26	83	38	12	4	1139219	1120505	1141100	1141101	1160391	1162031
16	32	92	44	16	4	1139237	1120506	1141102	1141103	1160417	1162040
18	32	92	44	16	4	1139255	1120507	1141104	1141105	1160435	1162059
20	38	98	54	16	4	-	-	-	-	1159991	1162066
20	38	104	54	20	4	1139273	1120508	1141106	1141107	1160444	1162068
22	38	104	54	20	4	1139291	1120509	1141110	1141109	1160453	1162077
24	45	121	65	25	4	1139317	1120510	1141112	1141111	1160462	1162079
25	45	121	65	25	4	1139326	1120511	1141116	1141113	1160471	1162086
28	45	121	65	25	5	1139344	1120512	1141118	1141115	1160499	1162095
30	45	121	65	25	5	1139353	1120513	1141120	1141119	1160505	1162102
32	53	133	73	32	6	1139362	1120514	1120527	1120531	1160514	1162111
36	53	133	73	32	6	1139399	1120515	1120528	1120532	1160523	1162113
40	63	155	85	40	6	1139415	1120516	1120529	1120533	-	-
40	63	143	85	32	-	-	-	-	-	1160541	1162115

Schaftfräser aus HSS-E-PM siehe Kat.-Nr. F 506, F 516, Seite 382
End Mills of HSS-E-PM see Cat.-No. F 506 C, F 516 C, Page 382

Schnittwertempfehlungen ab Seite 466
Cutting data recommendations starting page 466



stirnseitig bis Mitte schneidend
NC-gerecht
hinterschliffen

center cutting
suitable for NC
relief ground

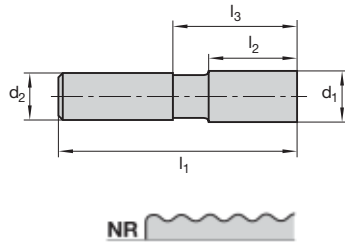

Katalog-Nr.	Cat.-No.	1506	1506 C	1516	1516 C	1556	1556 C
Typ	Type	NR					
Norm	Standard	DIN 844 A		DIN 844 B		DIN 844 D	
Drallwinkel	Helix angle	≈ 30°					
Zylinderschaft	Straight shank	DIN 1835 A		DIN 1835 B		DIN 1835 D	
Beschichtung	Coating	-	TiCN Plus	-	TiCN Plus	-	TiCN Plus
Werkstoff	Material	HSS-E EMo5Co5					

d ₁ k 12	l ₂	l ₁	l ₃	d ₂ h 6	z	Ident No.	Ident No.	Ident No.	Ident No.	Ident No.	Ident No.
8	38	88	47	10	4	1121402	1121403	1121404	1121405	1162415	1162709
10	45	95	57	10	4	1139594	1120517	1141509	1143605	1162424	1162718
12	53	110	65	12	4	1139601	1120518	1141518	1143614	1162442	1162727
14	53	110	65	12	4	1139610	1120519	1141527	1143623	1162451	1162736
16	63	123	75	16	4	1139629	1120520	1141536	1143632	1162479	1162745
18	63	123	75	16	4	1139638	1120521	1141545	1143641	1162488	1162754
20	75	135	91	16	4	-	-	-	-	1161407	1162761
20	75	141	91	20	4	1139647	1120522	1141554	1143650	1162497	1162763
25	90	166	110	25	4	1139665	1120523	1141572	1143678	1162521	1162781
30	90	166	110	25	5	1139683	1120524	1120539	1120534	1162558	1162807
32	106	186	126	32	6	1139692	1120525	1141590	1143696	1162567	1162816
36	106	186	126	32	6	1139709	1120526	1141607	1143698	1162576	1162818

Schaftfräser aus HSS-E-PM siehe Kat.-Nr. F 506, F 516, Seite 383
End Mills of HSS-E-PM see Cat.-No. F 506 C, F 516 C, Page 383

Schnittwertempfehlungen ab Seite 466
Cutting data recommendations starting page 466

stirnseitig bis Mitte schneidend
NC-gerecht
hinterschliffen

center cutting
suitable for NC
relief ground

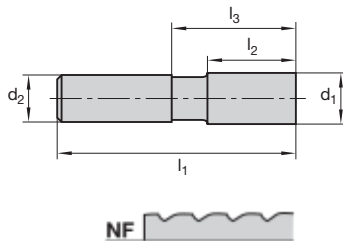

1505



1515



1555



Katalog-Nr.	Cat.-No.	1505	1505 C	1515	1515 C	1555	1555 C
Typ	Type	NF					
Norm	Standard	DIN 844 A		DIN 844 B		DIN 844 D	
Drallwinkel	Helix angle	≈ 30°					
Zylinderschaft	Straight shank	DIN 1835 A		DIN 1835 B		DIN 1835 D	
Beschichtung	Coating	-	TiCN Plus	-	TiCN Plus	-	TiCN Plus
Werkstoff	Material	HSS-E EMO5Co5					

d ₁ k 12	l ₂	l ₁	l ₃	d ₂ h 6	z	Ident No.	Ident No.	Ident No.	Ident No.	Ident No.	Ident No.
6	13	57	21	6	4	1138210	1120563	1133441	1338650	1159713	1163596
7	16	66	26	10	4	1138238	1120564	1120552	1120592	1159722	1163598
8	19	69	28	10	4	1138256	1120565	1133443	1338652	1159731	1163600
9	19	69	28	10	4	1138265	1120566	1120553	1120593	1159740	1163602
10	22	72	31	10	4	1138274	1120567	1133445	1338654	1159759	1163619
11	22	79	34	12	4	1138283	1120568	1120554	1120594	1159768	1163621
12	26	83	38	12	4	1138292	1120569	1133447	1338656	1159777	1163628
14	26	83	38	12	4	1138318	1120570	1120555	1120595	1159795	1163637
16	32	92	44	16	4	1138336	1120571	1133451	1338659	1159811	1163646
18	32	92	44	16	4	1138354	1120572	1120556	1120596	1159820	1163655
20	38	104	54	20	4	1138372	1120573	1133453	1338661	1159848	1163664
22	38	104	54	20	4	1138390	1120574	1120557	1120597	1159857	1163673
24	45	121	65	25	4	1138416	1120575	1120558	1120598	1159866	1163680
25	45	121	65	25	4	1138425	1120576	1133455	1338663	1159875	1163682
28	45	121	65	25	5	1138443	1120577	1120559	1120599	1159893	1163691
30	45	121	65	25	5	1138452	1120578	1133461	1338665	1159900	1163708
32	53	133	73	32	6	1138461	1120579	1133459	1338668	1159919	1163717
36	53	133	73	32	6	1138498	1120580	1120560	1120600	1159937	1163719
40	63	155	85	40	6	1138513	1120581	1120561	1120601		
40	63	143	85	32	6					1159946	1163721

Schaftfräser aus HSS-E-PM siehe Kat.-Nr. F 505, F 515, Seite 385
End Mills of HSS-E-PM see Cat.-No. F 505 C, F 515 C, Page 385

Schnittwertempfehlungen ab Seite 466
Cutting data recommendations starting page 466



stirnseitig bis Mitte schneidend
NC-gerecht
hinterschliffen

center cutting
suitable for NC
relief ground

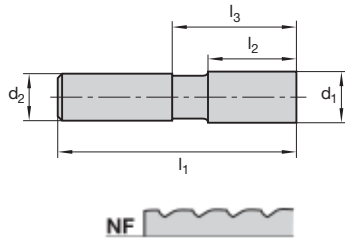

Katalog-Nr.	Cat.-No.	1505	1505 C	1515	1515 C	1555	1555 C
Typ	Type	NF					
Norm	Standard	DIN 844 A		DIN 844 B		DIN 844 D	
Drallwinkel	Helix angle	≈ 30°					
Zylinderschaft	Straight shank	DIN 1835 A		DIN 1835 B		DIN 1835 D	
Beschichtung	Coating	-	TiCN Plus	-	TiCN Plus	-	TiCN Plus
Werkstoff	Material	HSS-E EMo5Co5					

d ₁ k 12	l ₂	l ₁	l ₃	d ₂ h 6	z	Ident No.	Ident No.	Ident No.	Ident No.	Ident No.	Ident No.
8	38	88	47	10	4	1121406	1121407	1121408	1121409	1160916	1163744
10	45	95	57	10	4	1120542	1120582	1138604	1120602	1160925	1163753
12	53	110	65	12	4	1120543	1120583	1138606	1120603	1160943	1163762
14	53	110	65	12	4	1120544	1120584	1138608	1120604	1160961	1163771
16	63	123	75	16	4	1120545	1120585	1138610	1120605	1160989	1163780
18	63	123	75	16	4	1120546	1120586	1138612	1120606	1160998	1163799
20	75	141	91	20	4	1120547	1120587	1138614	1120607	1161005	1163806
25	90	166	110	25	4	1120548	1120588	1138618	1120608	1161032	1163824
30	90	166	110	25	5	1120549	1120589	1120562	1120609	1161069	1163842
32	106	186	126	32	6	1120550	1120590	1138624	1120610	1161078	1163851
36	106	186	126	32	6	1120551	1120591	1138626	1120611	1161087	1163853

stirnseitig bis Mitte schneidend
NC-gerecht
hinterschliffen

center cutting
suitable for NC
relief ground

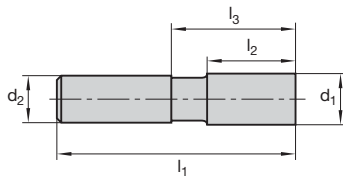

Katalog-Nr.	Cat.-No.	1414	1414 C
Typ	Type	WF	
Norm	Standard	DIN 327 D	
Drallwinkel	Helix angle	≈ 40°	
Zylinderschaft	Straight shank	DIN 1835 B	
Beschichtung	Coating	-	TiCN Plus
Werkstoff	Material	HSS-E EMo5Co5	

d ₁ k 12	l ₂	l ₁	l ₃	d ₂ h 6	Ident No.	Ident No.
10	13	63	23	10	1110356	1110349
12	16	73	28	12	1110366	1110351
16	19	79	31	16	1110301	1110355
20	22	88	38	20	1110310	1110359
25	26	102	46	25	1110329	1110363
30	26	102	46	25	1110418	1110367

Schnittwertempfehlungen ab Seite 466
Cutting data recommendations starting page 466

stirnseitig bis Mitte schneidend
 NC-gerecht
 hinterschliffen

center cutting
 suitable for NC
 relief ground

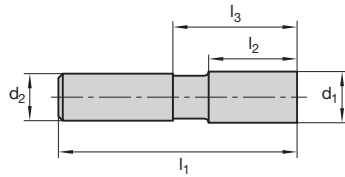

Katalog-Nr.	Cat.-No.	1414	1414 C
Typ	Type	WF	
Norm	Standard	DIN 844 B	
Drallwinkel	Helix angle	≈ 40°	
Zylinderschaft	Straight shank	DIN 1835 B	
Beschichtung	Coating	-	TiCN Plus
Werkstoff	Material	HSS-E EMo5Co5	

d ₁ k 12	l ₂	l ₁	l ₃	d ₂ h 6	Ident No.	Ident No.
10	22	72	31	10	1110376	1120798
12	26	83	38	12	1110378	1120799
16	32	92	44	16	1110382	1120800
20	38	104	54	20	1110386	1120801
25	45	121	65	25	1110390	1120802
30	45	121	65	25	1110396	1120803

Schnittwertempfehlungen ab Seite 466
 Cutting data recommendations starting page 466

**NC-gerecht
hinterschliffen**

suitable for NC
relief ground

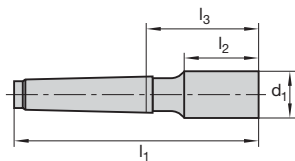

Katalog-Nr.	Cat.-No.	1536
Typ	Type	NR
Norm	Standard	DIN 845 B + C ¹⁾
Drallwinkel	Helix angle	≈ 25°
Morsekegel	Morse taper shank	DIN 228 A / DIN 2207
Beschichtung	Coating	-
Werkstoff	Material	HSS-E EMo5Co5

d ₁ k 12	l ₂	l ₁	l ₃	MK	z	Ident No.
16	32	117	53	2	4	1152612
18	32	117	53	2	4	1152630
20	38	123	59	2	4	1152658
22	38	123	59	2	4	1152676
24	45	147	66	3	4	1152694
25	45	147	66	3	4	1152701
28	45	147	66	3	4	1152729
30	45	147	66	3	4	1152738
32	53	155	74	3	6	1154139
32	53	201	103,5	4	6	1152747
36	53	201	103,5	4	6	1152774
40	63	211	103,5	4	6	1152792
45	63	211	103,5	4	6	1152809

¹⁾ DIN 845 Form B bis MK 3 - DIN 845 Form C ab MK 4

¹⁾ DIN 845 Form B up to morse taper No. 3 - DIN 845 Form C starting at morse taper No. 4

Schnittwertempfehlungen ab Seite 466

Cutting data recommendations starting page 466



**NC-gerecht
hinterschliffen**

suitable for NC
relief ground

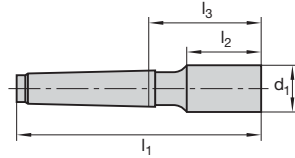

Katalog-Nr.	Cat.-No.	1536
Typ	Type	NR
Norm	Standard	DIN 845 B + C ¹⁾
Drallwinkel	Helix angle	≈ 25°
Morsekegel	Morse taper shank	DIN 228 A / DIN 2207
Beschichtung	Coating	-
Werkstoff	Material	HSS-E EMo5Co5

d ₁ k 12	l ₂	l ₁	l ₃	MK	z	Ident No.
16	63	148	84	2	4	1153103
16	63	165	84	3	4	1152854
18	63	148	84	2	4	1153112
18	63	165	84	3	4	1152863
20	75	160	96	2	4	1153121
20	75	177	96	3	4	1152872
22	75	160	96	2	4	1153130
25	90	192	111	3	4	1152890
28	90	192	111	3	4	1153149
28	112	265	162,5	4	4	1152907
30	90	192	111	3	4	1153158
30	112	265	162,5	4	4	1152916
32	106	254	156,5	4	6	1152925
36	106	254	156,5	4	6	1152934
36	125	273	175,5	4	6	1152943
40	100	292	162,5	5	6	1152952
40	125	273	175,5	4	6	1153167
40	125	317	187,5	5	6	1152961
40	160	352	222,5	5	6	1152970
45	125	273	175,5	4	6	1153176
45	100	292	162,5	5	6	1152989
45	160	352	222,5	5	6	1153005

¹⁾ DIN 845 Form B bis MK 3 - DIN 845 Form C ab MK 4

¹⁾ DIN 845 Form B up to morse taper No. 3 - DIN 845 Form C starting at morse taper No. 4

Schnittwertempfehlungen ab Seite 466

Cutting data recommendations starting page 466

NC-gerecht
hinterschliffen

suitable for NC
relief ground

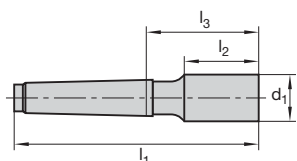

Katalog-Nr.	Cat.-No.	1535
Typ	Type	NF
Norm	Standard	DIN 845 B + C ¹⁾
Drallwinkel	Helix angle	≈ 25°
Morsekegel	Morse taper shank	DIN 228 A / DIN 2207
Beschichtung	Coating	-
Werkstoff	Material	HSS-E EMo5Co5

d ₁ k 12	l ₂	l ₁	l ₃	MK	z	Ident No.
16	32	117	53	2	4	1150712
18	32	117	53	2	4	1150730
20	38	123	59	2	4	1150758
22	38	123	59	2	4	1150776
24	45	147	66	3	4	1150794
25	45	147	66	3	4	1150801
28	45	147	66	3	4	1150829
30	45	147	66	3	4	1150838
32	53	155	74	3	6	1151631
32	53	201	103,5	4	6	1150847
36	53	201	103,5	4	6	1150874
40	63	211	113,5	4	6	1150892
45	63	211	113,5	4	6	1150909

¹⁾ DIN 845 Form B bis MK 3 - DIN 845 Form C ab MK 4

¹⁾ DIN 845 Form B up to morse taper No. 3 - DIN 845 Form C starting at morse taper No. 4

Schnittwertempfehlungen ab Seite 466

Cutting data recommendations starting page 466



**NC-gerecht
hinterschliffen**

suitable for NC
relief ground

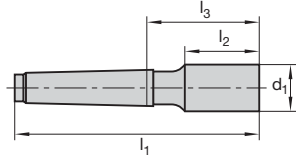

Katalog-Nr.	Cat.-No.	1535
Typ	Type	NF
Norm	Standard	DIN 845 B + C ¹⁾
Drallwinkel	Helix angle	≈ 25°
Morsekegel	Morse taper shank	DIN 228 A / DIN 2207
Beschichtung	Coating	-
Werkstoff	Material	HSS-E EMo5Co5

d ₁ k 12	l ₂	l ₁	l ₃	MK	z	Ident No.
16	63	148	84	2	4	1151702
18	63	148	84	2	4	1151711
18	63	165	84	3	4	1150963
20	75	160	96	2	4	1151720
20	75	177	96	3	4	1150972
22	75	160	96	2	4	1151739
22	90	192	111	3	4	1150981
25	90	192	111	3	4	1150990
28	90	192	111	3	4	1151748
28	112	265	162,5	4	4	1151007
30	90	192	111	3	4	1151757
30	112	265	162,5	4	4	1151016
32	106	254	156,5	4	6	1151025
36	106	254	156,5	4	6	1151034
36	125	273	175,5	4	6	1151043
40	125	273	175,5	4	6	1151766
40	125	317	187,5	5	6	1151061
45	125	273	175,5	4	6	1151775
45	160	352	222,5	5	6	1151105

¹⁾ DIN 845 Form B bis MK 3 - DIN 845 Form C ab MK 4

¹⁾ DIN 845 Form B up to morse taper No. 3 - DIN 845 Form C starting at morse taper No. 4

Schnittwertempfehlungen ab Seite 466

Cutting data recommendations starting page 466

NC-gerecht
hinterschliffen

suitable for NC
relief ground

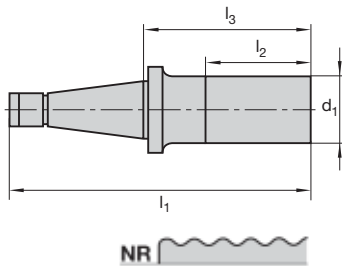

Katalog-Nr.	Cat.-No.	1546
Typ	Type	NR
Norm	Standard	DIN 2328
Drallwinkel	Helix angle	≈ 25°
Steilkegel	7/24 Taper	DIN 2080 A
Beschichtung	Coating	-
Werkstoff	Material	HSS-E EMo5Co5

d ₁ k 12	l ₂	l ₁	l ₃	SK	z	Ident No.
32	53	188	94,6	40	6	1156912
36	53	188	94,6	40	6	1156921
40	63	198	104,6	40	6	1156930
45	63	198	104,6	40	6	1156949
50	75	210	116,6	40	6	1157298
50	75	252	125,2	50	6	1156976
56	75	252	125,5	50	8	1156985
63	90	267	140,2	50	8	1156994
80	106	283	156,2	50	8	1157314

Schnittwertempfehlungen ab Seite 466
Cutting data recommendations starting page 466

**NC-gerecht
hinterschliffen**

suitable for NC
relief ground

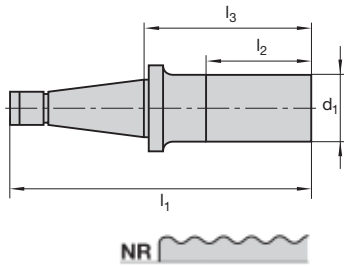

Katalog-Nr.	Cat.-No.	1546
Typ	Type	NR
Norm	Standard	DIN 2328
Drallwinkel	Helix angle	≈ 25°
Steilkegel	7/24 Taper	DIN 2080 A
Beschichtung	Coating	-
Werkstoff	Material	HSS-E EMo5Co5

d ₁ k 12	l ₂	l ₁	l ₃	SK	z	Ident No.
32	80	215	121,6	40	6	1157332
32	106	241	147,6	40	6	1157010
36	80	215	121,6	40	6	1157341
36	106	241	147,6	40	6	1157029
40	100	235	141,6	40	6	1157038
40	125	260	166,6	40	6	1157350
45	100	235	141,6	40	6	1157047
45	125	260	166,6	40	6	1157369
50	112	247	153,6	40	6	1157378
50	150	285	191,6	40	6	1157387
50	112	289	162,2	50	6	1157118
50	150	327	200,2	50	6	1157127
50	180	357	230,2	50	6	1157136
56	112	289	162,2	50	8	1157421
56	150	327	200,2	50	8	1157154
56	180	357	230,2	50	8	1157163
63	140	317	190,2	50	8	1157172
63	180	357	230,2	50	8	1157181
63	225	402	275,2	50	8	1157190
80	160	337	210,2	50	8	1157252
80	212	389	262,2	50	8	1157261
80	250	427	300,2	50	8	1157270
80	300	477	350,2	50	8	1157289

Schnittwertempfehlungen ab Seite 466
Cutting data recommendations starting page 466

NC-gerecht
hinterschliffen

suitable for NC
relief ground

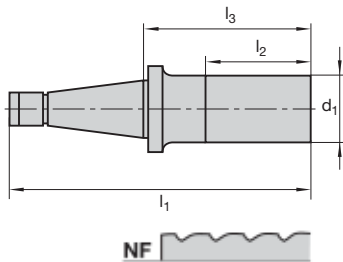

Katalog-Nr.	Cat.-No.	1545
Typ	Type	NF
Norm	Standard	DIN 2328
Drallwinkel	Helix angle	≈ 25°
Steilkegel	7/24 Taper	DIN 2080 A
Beschichtung	Coating	-
Werkstoff	Material	HSS-E EMo5Co5

d ₁ k 12	l ₂	l ₁	l ₃	SK	z	Ident No.
32	53	188	94,6	40	6	1156011
36	53	188	94,6	40	6	1156020
40	63	198	104,6	40	6	1156039
45	63	198	104,6	40	6	1156048
50	75	210	116,6	40	6	1156397
50	75	252	125,2	50	6	1156075
56	75	252	125,2	50	8	1156084
63	90	267	140,2	50	8	1156093
80	106	283	156,2	50	8	1156413

Schnittwertempfehlungen ab Seite 466
Cutting data recommendations starting page 466



**NC-gerecht
hinterschliffen**

suitable for NC
relief ground

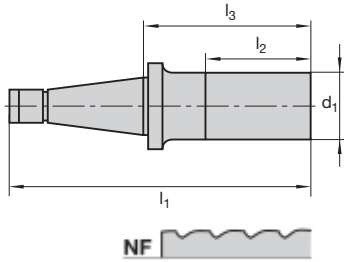

Katalog-Nr.	Cat.-No.	1545
Typ	Type	NF
Norm	Standard	DIN 2328
Drallwinkel	Helix angle	≈ 25°
Steilkegel	7/24 Taper	DIN 2080 A
Beschichtung	Coating	-
Werkstoff	Material	HSS-E EMo5Co5

d ₁ k 12	l ₂	l ₁	l ₃	SK	z	Ident No.
32	80	215	121,6	40	6	1156431
32	106	241	147,6	40	6	1156119
36	80	215	121,6	40	6	1156440
36	106	241	147,6	40	6	1156128
40	100	235	141,6	40	6	1156137
40	125	260	166,6	40	6	1156459
45		260	166,6	40	6	1156468
50	112	247	153,6	40	6	1156477
50	150	285	191,6	40	6	1156486
50	112	289	162,2	50	6	1156217
50	150	327	200,2	50	6	1156226
50	180	357	230,2	50	6	1156235
56	112	289	162,2	50	8	1156529
56	150	327	200,2	50	8	1156253
56	180	357	230,2	50	8	1156262
63	140	317	190,2	50	8	1156271
63	180	357	230,2	50	8	1156280
63	225	402	275,2	50	8	1156299
80	160	337	210,2	50	8	1156351
80	212	389	262,2	50	8	1156360
80	250	427	300,2	50	8	1156379
80	300	477	350,2	50	8	1156388

Schnittwertempfehlungen ab Seite 466
Cutting data recommendations starting page 466

NC-gerecht
hinterschliffen

suitable for NC
relief ground

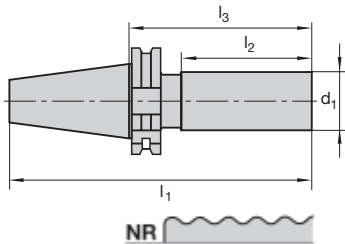

Katalog-Nr.	Cat.-No.	1547
Typ	Type	NR
Norm	Standard	≈ DIN 2328
Drallwinkel	Helix angle	≈ 25°
Steilkegel	7/24 Taper	DIN 69871 A
Beschichtung	Coating	-
Werkstoff	Material	HSS-E EMo5Co5

d ₁ k 12	l ₂	l ₁	l ₃	SK	z	Ident No.
32	53	171	102,6	40	6	1155654
36	53	171	102,6	40	6	1155656
40	63	181	112,6	40	6	1155658
50	75	193	124,6	40	6	1155660
50	75	231	129,25	50	6	1155664
63	90	246	144,25	50	8	1155673
80	106	262	160,25	50	8	1155682

Anzugsbolzen für Steilkegel siehe LMT-Katalog „Spannen“ ab Seite 221
Pull Stud NC for steep taper refer LMT Catalogue “Chucking” starting page 221

Schnittwertempfehlungen ab Seite 466
Cutting data recommendations starting page 466



**NC-gerecht
hinterschliffen**

suitable for NC
relief ground

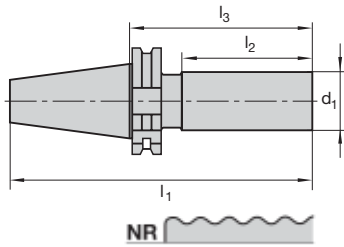

Katalog-Nr.	Cat.-No.	1547
Typ	Type	NR
Norm	Standard	≈ DIN 2328
Drallwinkel	Helix angle	≈ 25°
Steilkegel	7/24 Taper	DIN 69871 A
Beschichtung	Coating	-
Werkstoff	Material	HSS-E EMo5Co5

d ₁ k 12	l ₂	l ₁	l ₃	SK	z	Ident No.
36	106	224	155,6	40	6	1155816
40	125	243	174,6	40	6	1155818
50	150	268	199,6	40	6	1155820
40	100	256	154,25	50	6	1155824
40	160	316	214,25	50	6	1155842
50	112	268	166,25	50	6	1155851
50	150	306	204,25	50	6	1155860
50	180	336	234,25	50	6	1155879
63	140	296	194,25	50	8	1155888
63	180	336	234,25	50	8	1155897
63	225	381	279,25	50	8	1155904
80	212	368	266,25	50	8	1155913
80	250	406	304,25	50	8	1155922
80	300	456	354,25	50	8	1155931

Anzugsbolzen für Steilkegel siehe LMT-Katalog „Spannen“ ab Seite 221
Pull Stud NC for steep taper refer LMT Catalogue “Chucking” starting page 221

Schnittwertempfehlungen ab Seite 466
Cutting data recommendations starting page 466

für Tiefräsoperationen
NC-gerecht

for deep milling operations
suitable for NC

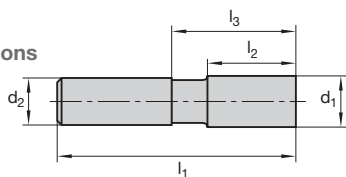

Katalog-Nr.	Cat.-No.	1554
Typ	Type	N
Norm	Standard	WN
Drallwinkel	Helix angle	≈ 30°
Zylinderschaft	Straight shank	DIN 1835 B / D
Beschichtung	Coating	-
Werkstoff	Material	HSS-E 909 M 42

d ₁ k 10	l ₂	l ₁	l ₃	d ₂ h 6	z	Ident No.
6	60	104	68	6	4	1159401
8	60	110	70	10	4	1159410
10	60	110	70	10	4	1159429
12	100	157	112	12	4	1159438
16	150	210	162	16	4	1159456
20	180	246	196	20	4	1159474

Schnittwertempfehlungen ab Seite 466
Cutting data recommendations starting page 466

stirnseitig bis Mitte schneidend
für Tieffräsoperationen
NC-gerecht

center cutting
for deep milling
operations
suitable for NC

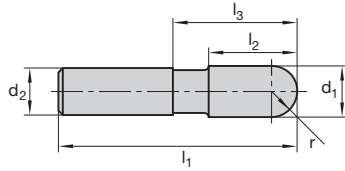

Katalog-Nr.	Cat.-No.	1553
Typ	Type	N
Norm	Standard	WN
Drallwinkel	Helix angle	≈ 30°
Zylinderschaft	Straight shank	DIN 1835 B / D
Beschichtung	Coating	-
Werkstoff	Material	HSS-E E 909 M 42

d ₁ k 10	r	l ₂	l ₁	l ₃	d ₂ h 6	z	Ident No.
6	3	60	104	68	6	4	1159615
8	4	60	110	70	10	4	1159624
10	5	60	110	70	10	4	1159633
12	6	100	157	112	12	4	1159642
16	8	150	210	162	16	4	1159660
20	10	180	246	196	20	4	1159688

Schnittwertempfehlungen ab Seite 466
 Cutting data recommendations starting page 466

Werkstoff	Material	R _m /UTS (N/mm ²)	HSS-E TiCN Plus v _c [m/min]	f _z bei Fräser d ₁ mm f _z at cutter dia. d ₁ mm						Leistungs- faktor Efficiency factor LF
				3	8	12	20	32	> 50	
Unlegierter Baustahl	Plain carbon steel	-700	55	0,016	0,05	0,07	0,09	0,1	0,12	20
Automatenstahl	Free cutting steel	-700	55	0,016	0,05	0,07	0,09	0,1	0,12	20
Baustahl	Structural alloy steel	500-950	45	0,014	0,045	0,06	0,08	0,1	0,12	18
Vergütungsstahl, mittelfest	Heat-treatable steel, medium strength	500-950	45	0,014	0,05	0,06	0,08	0,1	0,12	18
Stahlguß	Cast steel	-950	35	0,012	0,04	0,05	0,08	0,1	0,12	18
Einsatzstahl	Case hardening steel	-950	50	0,016	0,05	0,06	0,08	0,1	0,12	18
Rost- und säurebeständiger Stahl, ferritisch, martensitisch	Stainless steel, ferritic, martensitic	500-950	25	0,012	0,04	0,05	0,06	0,08	0,1	16
Vergütungsstahl, hochfest	Heat-treatable steel, high strength	950-1400	30	0,012	0,04	0,05	0,08	0,1	0,12	13
Nitrierstahl, vergütet	Nitriding steel	950-1400	30	0,012	0,04	0,05	0,08	0,1	0,12	15
Werkzeugstahl	Tool steel	950-1400	30	0,012	0,04	0,05	0,08	0,1	0,12	13
Rost- und säurebeständiger Stahl, austenitisch	Stainless steel, austenitic	500-950	35	0,014	0,05	0,06	0,07	0,08	0,1	15
Martensitaushärtbarer Stahl	Maraging steel	500-950	35	0,014	0,05	0,06	0,07	0,08	0,1	15
Grauguß	Grey cast iron	100-400 (120-260 HB)	50	0,022	0,08	0,1	0,12	0,16	0,2	30
Legierter Grauguß	Alloyed grey cast iron	150-250 (160-230 HB)	40	0,014	0,05	0,06	0,08	0,1	0,12	25
Sphäroguß	Nodular cast iron	400-800 (120-310 HB)	50	0,016	0,05	0,06	0,1	0,12	0,15	24
Temperguß	Malleable cast iron	350-700 (150-280 HB)	70	0,016	0,05	0,06	0,1	0,12	0,15	30
Rein-Metalle, weich	Pure metals, soft	-500								
Aluminium-Legierungen, langspanend	Aluminium alloys, long chipping	-550	220 400	0,01 0,008	0,03 0,02	0,06 0,05	0,09 0,08	0,12 0,1	0,15 0,12	30 30
Aluminium-Legierungen, kurzspanend	Aluminium alloys, short chipping	-400	110	0,01	0,0	0,05	0,08	0,1	0,1	25
Kupfer-Legierungen, langspanend	Copper alloys, long chipping	300-700	100	0,01	0,03	0,06	0,09	0,12	0,15	30
Kupfer-Legierungen, kurzspanend	Copper alloys, short chipping	-500	70	0,01	0,02	0,05	0,08	0,1	0,12	35
Magnesium-Legierungen	Magnesium alloys	160-300								
Thermoplaste	Thermoplastics	40-70	350 160	0,01 0,01	0,02 0,03	0,06 0,06	0,09 0,09	0,12 0,12	0,15 0,15	25 25
Duroplaste	Duroplastics	20-40								
Graphit	Graphite		100	0,01	0,03	0,06	0,09	0,12	0,15	25
Titan-Legierungen, mittelfest	Titanium alloys, medium strength	-950	25 ¹⁾	0,014	0,024	0,05	0,08	0,08	0,1	18
Titan-Legierungen, hochfest	Titanium alloys, high strength	900-1400	12 ¹⁾	0,008	0,02	0,04	0,06	0,07	0,08	14
Nickelbasis-Legierungen, mittelfest	Nickel based alloys, medium strength	-950	30	0,02	0,05	0,08	0,1	0,12	0,15	18
Nickel-Basis-Legierungen, hochwarmfest	Heat resistant nickel based alloys, high strength	900-1400	12	0,01	0,03	0,06	0,07	0,08	0,09	16
Hartguß	Chilled cast iron	300-600								
gehärteter Stahl	hardened steel		20	0,012	0,04	0,05	0,08	0,09	0,1	25

¹⁾ Empfehlung: Fräser unbeschichtet einsetzen mit diesen Werten

¹⁾ Recommended: use uncoated end mills with these values

Drehzahl Speed $n = \frac{v_c \cdot 1000}{\pi \cdot d_1} \cdot f_1$ v_c Tab. Seite 466 Page 466	Vorschubgeschwindigkeit Feed rate $v_f = f_z \cdot z \cdot n \cdot f_2$ f_z Tab. Seite 466 Page 466	a_e = Schnittbreite in mm Width of cut in mm a_p = Schnitttiefe in mm Depth of cut in mm d_1 = Durchmesser in mm Cutter diameter in mm f_1 = Korrekturfaktor für v_c Correction factor v_c f_2 = Korrekturfaktor für v_f Correction factor v_f f_z = Vorschub pro Zahn in mm Feed per tooth in mm LF = Leistungsfaktor in $\text{cm}^3/\text{min}/\text{kW}$ Efficiency factor in $\text{cm}^3/\text{min}/\text{kW}$ n = Drehzahl in min^{-1} Speed in min^{-1} P_e = Spindelleistung in kW Drive power in kW Q = Spanvolumen in cm^3/min Chip volume in cm^3/min v_c = Schnittgeschwindigkeit in m/min Cutting speed in m/min v_f = Vorschubgeschwindigkeit in mm/min Feed rate in mm/min z = Anzahl der Schneiden No. of teeth
Spanvolumen Chip volume $Q = \frac{a_e \cdot a_p \cdot v_f}{1000}$	Spindelleistung Drive power $P_e \approx \frac{Q}{LF}$	

Schnittgeschwindigkeitskorrektur f_1 Cutting speed correction factor f_1

	unbeschichtet uncoated	TiN	TiCN	TiCN Plus	AL Plus
$f_1 =$	0,6	0,8	1	1	1

Vorschubkorrektur f_2 Cutting speed correction factor f_2

Fräser mit Schrupp-Profil Milling Cutters with roughing-profile			
$f_2 =$	1,0	0,8	0,5
Fräser mit Schlicht-Profil Milling Cutters with finishing-profile			
$f_2 =$	1,0	0,7	0,4
Langloch-/Bohrnutenfräser Slotting End Mills		I. Bohren Slotting	II. Fräsen Milling
		$z = 2$ $z = 3$	$z = 2$ $z = 3$
$f_2 =$		0,3	0,6 0,7



PM-Edition Walzenstirnfräser

PM-Edition Shell End Mills

Auswahlübersicht Selection tables	470
Typenbeschreibungen Type descriptions	471
Walzenstirn-Schlichtfräser Finishing Shell End Mills	472
Walzenstirn-Schruppfräser Finishing Shell End Mills	474
Schnittwertempfehlungen Cutting data recommendations	478

Auswahlübersicht Selection table





PM-Edition Walzenstirnfräser PM-Edition Shell End Mills

				Seite Page					
				472	473	474	475	476	477
<ul style="list-style-type: none"> ● sehr gut geeignet well suited ○ auch geeignet also suited 									
Typ				N	SN	NR	NF	HR	HF
≈ Drallwinkel Helix angle				30°	40°	30°	30°	30°	30°
Spanwinkel Rake angle				11°	16°	11°	11°	7°	7°
				Schlichten Finishing			Schruppen Roughing		
Werkstoff	Material	R_m/UTS (N/mm²)							
Unlegierter Baustahl	Plain carbon steel	- 700	●	●	●	●	○	○	
Automatenstahl	Free cutting steel	- 700	●	●	●	●	○	○	
Baustahl	Structural low alloy steel	500 - 950	●	●	●	●	○	○	
Vergütungsstahl, mittelfest	Heat-treatable steel, medium strength	500 - 950	●	●	●	●	○	○	
Stahlguss	Cast steel	- 950	●	●	●	●	○	○	
Einsatzstahl	Case hardening steel	- 950	●	●	●	●	○	○	
Rost- und säurebeständiger Stahl, ferritisch, martensitisch	Stainless steel, ferritic, martensitic	500 - 950	●	●	●	●	○	○	
Vergütungsstahl, hochfest	Heat-treatable steel, high strength	950 - 1400	○	○	○	○	●	●	
Nitrierstahl, vergütet	Nitriding steel	950 - 1400	○	○	○	○	●	●	
Werkzeugstahl (bis 45 HRC)	Tool steel (to 45 HRC)	950 - 1400	○	○	○	○	●	●	
Rost- und säurebeständiger Stahl, austenitisch	Stainless steel, austenitic	500 - 950			●	●	●	●	
Martensitaushärtbarer Stahl	Maraging steel				●	●	●	●	
Grauguss	Grey cast iron	100 - 400 (120 - 260 HB)	●	○	●	●	●	●	
Legierter Grauguss	Alloyed grey cast iron	150 - 250 (160 - 230 HB)	●	○	●	●	●	●	
Sphäroguss	Nodular cast iron	400 - 800 (120 - 310 HB)	●	○	●	●	●	●	
Temperguss	Malleable cast iron	350 - 700 (150 - 280 HB)	●	○	●	●	●	●	
Rein-Metalle, weich	Pure metals, soft	- 500	○	●	○	○			
Aluminium-Legierungen, langspanend	Aluminium alloys, long chipping	- 550	○	●	○	○			
Aluminium-Legierungen, kurzspanend	Aluminium alloys, short chipping	- 400	●	●	●	●	●	●	
Kupfer-Legierungen, langspanend	Copper alloys, long chipping	300 - 700	○	●	○	○			
Kupfer-Legierungen, kurzspanend	Copper alloys, short chipping	- 500	●	●	●	●	●	●	
Magnesium-Legierungen	Magnesium alloys	150 - 300	●	●	●	●	●	●	
Thermoplaste	Thermoplastics	40 - 70	○	●	○	○			
Duroplaste	Duroplastics	20 - 40	●	●	●	●	●	●	
Graphit	Graphite								
Titanlegierungen, mittelfest	Titanium alloys, medium strength	- 950	○	●	●	●	●	●	
Titanlegierungen, hochfest	Titanium alloys, high strength	900 - 1400	○	●	○	○	●	●	
Nickelbasislegierungen, mittelfest	Nickel based alloys, medium strength	- 950	○	●	○	○	●	●	
Nickelbasislegierungen, hochwarmfest	Heat resistant nickel based alloys, high strength	900 - 1400	○	○	○	○	●	●	
Hartguss	Chilled cast iron	300 - 600	○	○	○	○	●	●	

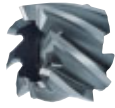
Typenbeschreibung Type description

PM-Edition Walzenstirnfräser PM-Edition Shell End Mills

	Walzenstirn-Schlichtfräser Finishing Shell End Mills	DIN	Kat.-Nr. Cat.-No.	TiCN Plus	Seite Page
Typ N 	grob gezahnt ≈ 30° Rechtsdrall 11° Spanwinkel Für Bau-, Einsatz-, Vergütungsstähle mit normaler Festigkeit bis 1000 N/mm ² sowie kurzspanende NE-Metalle. coarse tooth ≈ 30° R.H. spiral 11° rake angle For structural, case-hardening and heat-treatable steels with normal tensile strength of up to 1000 N/mm ² , also short-chip-producing non-ferrous metals.	1880	F 011	F 011 C	472
Typ SN 	grob gezahnt ≈ 40° Rechtsdrall 16° Spanwinkel Für rost- und säurebeständige Stähle, Titanlegierungen. Besonders geeignet für Gleichlaufräsen. coarse tooth ≈ 40° R.H. spiral 16° rake angle For stainless and acidresistant steels, titanium alloys. Specially suited for climb milling.	1880	F 013	F 013 C	473

	Walzenstirn-Schruppfräser Roughing Shell End Mills	DIN	Kat.-Nr. Cat.-No.	TiCN Plus	Seite Page
Typ NR 	Drallwinkel ≈ 30°, Spanwinkel: 11° Schrupp-Kordelverzahnung Vorzugsweise für Werkstoffe bis mittlerer Festigkeit (≈ 1100 N/mm ²). Vorwiegend langspanend. Helix angle ≈ 30°, rake angle: 11° Knuckle type for roughing preferably for materials up to medium tensile strength (≈ 1100 N/mm ²). Mostly long-chip-producing.	1880	F 016	F 016 C	474
Typ NF 	Drallwinkel ≈ 30°, Spanwinkel: 11° Schrupp-Schlichtverzahnung Großer Anwendungsbereich bei Werkstoffen mit mittlerer und hoher Festigkeit bis 1200 N/mm ² , z. B. Einsatz-, Vergütungsstähle, NE-Metalle sowie Gußeisen und Gußlegierungen. Helix angle ≈ 30°, rake angle: 11° Truncated type for roughing and shell end mills, Broad range of applications on materials of medium strength up to high tensile strength up to 1200 N/mm ² , for example case-hardening, heat-treatable steels, non-ferrous metals, also cast iron and alloy cast iron.	1880	F 015	F 015 C	475
Typ HR 	feine Schrupp-Kordelverzahnung fine tooth knuckle type for roughing Großer Anwendungsbereich bei Werkstoffen mit mittlerer bis hoher Festigkeit (ca. 900–1400 N/mm ²), z. B. Einsatz-, Vergütungsstähle, Werkzeugstahl legiert, vergütet, NE-Metalle, hochwarmfeste Werkstoffe sowie Gußeisen und Gußlegierungen. Drallwinkel ≈ 30°, Spanwinkel: 7°	1880	F 019	F 019 C	476
Typ HF 	feine Schrupp-Schlichtverzahnung fine tooth truncated type for roughing Broad range of applications on materials of medium strength up to high tensile strength (~ 900–1400 N/mm ²), for example case-hardening, heat-treatable steels, alloy tool steel; hardened and tempered non-ferrous metals, high temperature materials, also cast iron and alloy cast iron. Helix angle ≈ 30°, rake angle: 7°	1880	F 017	F 017 C	477

mit Längs- und Quernut
NC-gerecht

with standard keyway and drive slot
suitable for NC

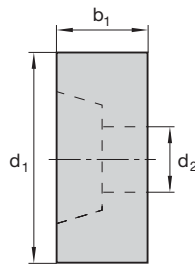

Katalog-Nr.	Cat.-No.	F 011	F 011 C
Typ	Type	N	
Norm	Standard	DIN 1880	
Drallwinkel	Helix angle	≈ 30°	
Beschichtung	Coating	-	TiCN Plus
Werkstoff	Material	HSS-E-PM	HSS-E-PM

d ₁ k 12	b ₁ k 16	d ₂ H 7	z	Ident No.	Ident No.
40	32	16	8	1121545	1121551
50	36	22	8	1121546	1121552
63	40	27	8	1121547	1121553
80	45	27	10	1121548	1121554
100	50	32	10	1121550	1121555

mit Längs- und Quernut
 NC-gerecht

with standard keyway and drive slot
 suitable for NC

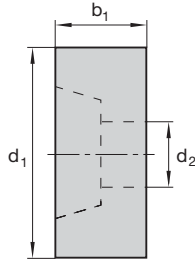

Katalog-Nr.	Cat.-No.	F 013	F 013 C
Typ	Type	SN	
Norm	Standard	≈ DIN 1880	
Drallwinkel	Helix angle	≈ 40°	
Beschichtung	Coating	-	TiCN Plus
Werkstoff	Material	HSS-E-PM	HSS-E-PM

d ₁ k 12	b ₁ k 16	d ₂ H 7	z	Ident No.	Ident No.
40	32	16	8	1136623	1136624
50	36	22	8	1136625	1136626
63	40	27	8	1136627	1136628
80	45	27	10	1136629	1136630

Sonderausführungen und andere Beschichtungen auf Anfrage
 Special designs and other coatings on request

Schnittwertempfehlungen ab Seite 478
 Cutting data recommendations starting page 478

mit Längs- und Quernut
hinterschliffen
NC-gerecht

with standard keyway and drive slot
relief ground
suitable for NC

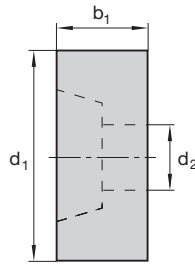

Katalog-Nr.	Cat.-No.	F 016	F 016 C
Typ	Type	NR	
Norm	Standard	DIN 1880	
Drallwinkel	Helix angle	≈ 30°	
Beschichtung	Coating	-	TiCN Plus
Werkstoff	Material	HSS-E-PM	HSS-E-PM

d ₁ k 12	b ₁ k 16	d ₂ H 7	z	Ident No.	Ident No.
40	32	16	6	1013614	1013615
50	36	22	8	1013616	1013617
63	40	27	8	1013618	1013619
80	45	27	10	1013622	1013621
100	50	32	10	1121556	1121557

Sonderausführungen und andere Beschichtungen auf Anfrage
Special designs and other coatings on request

Schnittwertempfehlungen ab Seite 478
Cutting data recommendations starting page 478

mit Längs- und Quernut
hinterschliffen
NC-gerecht

with standard keyway and drive slot
relief ground
suitable for NC

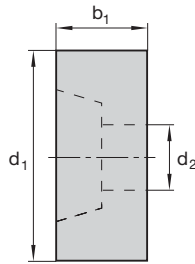

Katalog-Nr.	Cat.-No.	F 015	F 015 C
Typ	Type	NF	
Norm	Standard	DIN 1880	
Drallwinkel	Helix angle	≈ 30°	
Beschichtung	Coating	-	TiCN Plus
Werkstoff	Material	HSS-E-PM	HSS-E-PM

d ₁ k 12	b ₁ k 16	d ₂ H 7	z	Ident No.	Ident No.
40	32	16	6	1136781	1136763
50	36	22	8	1136783	1136765
63	40	27	8	1136785	1136767
80	45	27	10	1136787	1136769
100	50	32	10	1121559	1121560

Sonderausführungen und andere Beschichtungen auf Anfrage
Special designs and other coatings on request

Schnittwertempfehlungen ab Seite 478
Cutting data recommendations starting page 478

mit Längs- und Quernut
hinterschliffen
NC-gerecht

with standard keyway and drive slot
relief ground
suitable for NC

HR 

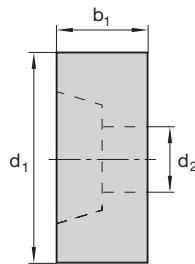

Katalog-Nr.	Cat.-No.	F 019	F 019 C
Typ	Type	HR	
Norm	Standard	DIN 1880	
Drallwinkel	Helix angle	≈ 30°	
Beschichtung	Coating	-	TiCN Plus
Werkstoff	Material	HSS-E-PM	HSS-E-PM

d ₁ k 12	b ₁ k 16	d ₂ H 7	z 	Ident No.	Ident No.
40	32	16	6	1136780	1136762
50	36	22	8	1136782	1136764
63	40	27	10	1136786	1136768
80	45	27	10	1136788	1136770
100	50	32	12	1121561	1121562

Sonderausführungen und andere Beschichtungen auf Anfrage
Special designs and other coatings on request

Schnittwertempfehlungen ab Seite 478
Cutting data recommendations starting page 478

mit Längs- und Quernut
hinterschliffen
NC-gerecht

with standard keyway and drive slot
relief ground
suitable for NC

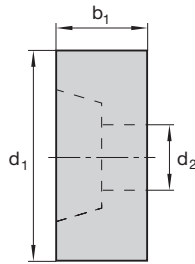

Katalog-Nr.	Cat.-No.	F 017	F 017 C
Typ	Type	HF	
Norm	Standard	DIN 1880	
Drallwinkel	Helix angle	≈ 30°	
Beschichtung	Coating	-	TiCN Plus
Werkstoff	Material	HSS-E-PM	HSS-E-PM

d ₁ k 12	b ₁ k 16	d ₂ H 7	z	Ident No.	Ident No.
40	32	16	6	1136700	1136690
50	36	22	8	1136701	1136692
63	40	27	10	1136703	1136694
80	45	27	10	1136705	1136696
100	50	32	12	1121563	1121564

	Werkstoff	Material	R_m/UTS (N/mm²)	HSS-E TiCN Plus v_c m/min	f_z mm	Leistungsfaktor Efficiency factor LF
Blue	Unlegierter Baustahl	Plain carbon steel	-700	90	0,22	20
	Automatenstahl	Free cutting steel	-700	90	0,22	20
	Baustahl	Structural alloy steel	500-950	70	0,18	18
	Vergütungsstahl, mittelfest	Heat-treatable steel, medium strength	500-950	60	0,18	18
	Stahlguss	Cast steel	-950	45	0,15	18
	Einsatzstahl	Case hardening steel	-950	60	0,20	18
	Rost- und säurebeständiger Stahl, ferritisch, martensitisch	Stainless steel, ferritic, martensitic	500-950	45	0,18	16
	Vergütungsstahl, hochfest	Heat-treatable steel, high strength	950-1400	40	0,15	13
	Nitrierstahl, vergütet	Nitriding steel	950-1400	40	0,15	15
	Werkzeugstahl	Tool steel	950-1400	40	0,15	13
	Yellow	Rost- und säurebeständiger Stahl, austenitisch	Stainless steel, austenitic	500-950	45	0,20
Martensitaushärtbarer Stahl		Maraging steel	500-950	45	0,20	15
Grauguss		Grey cast iron	100-400 (120-260 HB)	60	0,18	30
Red	Legierter Grauguss	Alloyed grey cast iron	150-250 (160-230 HB)	50	0,18	25
	Sphäroguss	Nodular cast iron	400-800 (120-310 HB)	50	0,18	24
	Temperguss	Malleable cast iron	350-700 (150-280 HB)	70	0,18	30
	Rein-Metalle, weich	Pure metals, soft	-500	240	0,2	30
Green	Aluminium-Legierungen, langspanend	Aluminium alloys, long chipping	-550	450	0,2	30
	Aluminium-Legierungen, kurzspanend	Aluminium alloys, short chipping	-400	140	0,2	25
	Kupfer-Legierungen, langspanend	Copper alloys, long chipping	300-700	120	0,20	30
	Kupfer-Legierungen, kurzspanend	Copper alloys, short chipping	-500	90	0,16	35
	Magnesium-Legierungen	Magnesium alloys	160-300	400	0,18	25
	Thermoplaste	Thermoplastics	40-70	180	0,18	25
	Duroplaste	Duroplastics	20-40	120	0,18	25
	Graphit	Graphite				
Orange	Titan-Legierungen, mittelfest	Titanium alloys, medium strength	-950	30 ¹⁾	0,12	18
	Titan-Legierungen, hochfest	Titanium alloys, high strength	900-1400	15 ¹⁾	0,09	16
	Nickelbasis-Legierungen, mittelfest	Nickel based alloys, medium strength	-950	40	0,18	18
	Nickel-Basis-Legierungen, hochwarmfest	Heat resistant nickel based alloys, high strength	900-1400	15	0,14	14
	Hartguss	Chilled cast iron	300-600	25	0,15	25

¹⁾ Empfehlung: Fräser unbeschichtet einsetzen mit diesen Werten

¹⁾ Recommended: use uncoated end mills with these values

Drehzahl Speed $n = \frac{v_c \cdot 1000}{\pi \cdot d_1} \cdot f_1$ v_c Tab. Seite 478 Page 478	Vorschubgeschwindigkeit Feed rate $v_f = f_z \cdot z \cdot n \cdot f_2$ f_z Tab. Seite 478 Page 478	a_e = Schnittbreite in mm Width of cut in mm a_p = Schnitttiefe in mm Depth of cut in mm d_1 = Durchmesser in mm Cutter diameter in mm f_1 = Korrekturfaktor für v_c Correction factor v_c f_2 = Korrekturfaktor für v_f Correction factor v_f f_z = Vorschub pro Zahn in mm Feed per tooth in mm LF = Leistungsfaktor in $\text{cm}^3/\text{min}/\text{kW}$ Efficiency factor in $\text{cm}^3/\text{min}/\text{kW}$ n = Drehzahl in min^{-1} Speed in min^{-1} P_e = Spindelleistung in kW Drive power in kW Q = Spanvolumen in cm^3/min Chip volume in cm^3/min v_c = Schnittgeschwindigkeit in m/min Cutting speed in m/min v_f = Vorschubgeschwindigkeit in mm/min Feed rate in mm/min z = Anzahl der Schneiden No. of teeth
Spanvolumen Chip volume $Q = \frac{a_e \cdot a_p \cdot v_f}{1000}$	Spindelleistung Drive power $P_e \approx \frac{Q}{LF}$	

Schnittgeschwindigkeitskorrektur f_1 Cutting speed correction factor f_1

	unbeschichtet uncoated	TiN	TiCN	TiCN Plus	AL Plus
$f_1 =$	0,6	0,8	1	1	1

Vorschubkorrektur f_2 Cutting speed correction factor f_2

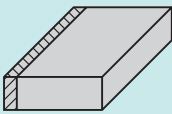
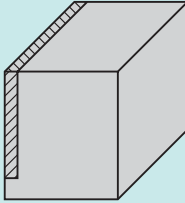
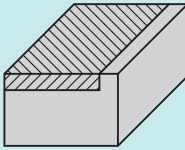
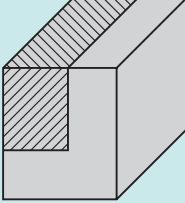
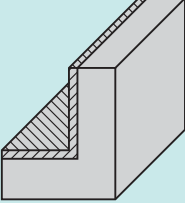
					
	$a_e < 0,1 \cdot d_1$ –	$a_e < 0,1 \cdot d_1$ –	$a_e < 0,75 \cdot d_1$ $a_p < 0,1 \cdot b_1$	$a_e > 0,2 \cdot d_1$ $a_p > 0,1 \cdot b_1$	$a_e < 0,1 \cdot d_1$ $a_p < 0,1 \cdot b_1$
Schrappfräser Roughing Milling Cutters $f_2 =$	1	1	0,6	0,5	–
Schlichtfräser Finishing Milling Cutters $f_2 =$	0,8	0,8	0,5	–	0,5









Walzenstirnfräser HSS-E

Shell End Mills HSS-E

Auswahlübersichten Selection tables	482
Typenbeschreibungen Type descriptions	483
Walzenstirn-Schlichtfräser Finishing Shell End Mills	485
Walzenstirn-Schrupfräser Roughing Shell End Mills	491
Schnittwertempfehlungen Cutting data recommendations	494



Auswahlübersicht Selection table

Walzenstirnfräser Shell End Mills

<ul style="list-style-type: none"> ● sehr gut geeignet well suited ○ auch geeignet also suited 			Seite Page						
			früher previously DIN 841						
			486				490	493	493
			DIN 1880						
			485	487	488	489	489	491	492
									
Typ			N	SN	NVT	H	W	NR	NF
≈ Drallwinkel Helix angle			30°	40°	25°	15°	40°	30°	30°
Spanwinkel Rake angle			11°	16°	88	7°	22°	11°	11°
			Schlichten Finishing					Schruppen Roughing	
Werkstoff	Material	R _m /UTS (N/mm ²)							
Unlegierter Baustahl	Plain carbon steel	- 700	●	●	●	○	○	●	●
Automatenstahl	Free cutting steel	- 700	●	●	●	○	○	●	●
Baustahl	Structural low alloy steel	500 - 950	●	●	●	○	○	●	●
Vergütungsstahl, mittelfest	Heat-treatable steel, medium strength	500 - 950	●	●	●	○		●	●
Stahlguss	Cast steel	- 950	●	●	●	○		●	●
Einsatzstahl	Case hardening steel	- 950	●	●	●	○		●	●
Rost- und säurebeständiger Stahl, ferritisch, martensitisch	Stainless steel, ferritic, martensitic	500 - 950	●	●	●	○	○	●	●
Vergütungsstahl, hochfest	Heat-treatable steel, high strength	950 - 1400	○	○	○	●		○	○
Nitrierstahl, vergütet	Nitriding steel	950 - 1400	○	○	○	●		○	○
Werkzeugstahl (bis 45 HRC)	Tool steel (to 45 HRC)	950 - 1400	○	○	○	●		○	○
Rost- und säurebeständiger Stahl, austenitisch	Stainless steel, austenitic	500 - 950	○	●	●	●		●	●
Martensitaushärtbarer Stahl	Maraging steel								
Grauguss	Grey cast iron	100 - 400 (120 - 260 HB)	●	○	●	●		●	●
Legierter Grauguss	Alloyed grey cast iron	150 - 250 (160 - 230 HB)	●	○	●	●		●	●
Sphäroguss	Nodular cast iron	400 - 800 (120 - 310 HB)	●	○	●	●		●	●
Temperguss	Malleable cast iron	350 - 700 (150 - 280 HB)	●	○	●	●		●	●
Rein-Metalle, weich	Pure metals, soft	- 500	○	●			●	○	○
Aluminium-Legierungen, langspanend	Aluminium alloys, long chipping	- 550	○	●			●	○	○
Aluminium-Legierungen, kurzspanend	Aluminium alloys, short chipping	- 400	●	●	●		○	●	●
Kupfer-Legierungen, langspanend	Copper alloys, long chipping	300 - 700	○	●			●	○	○
Kupfer-Legierungen, kurzspanend	Copper alloys, short chipping	- 500	●	●	●		○	●	●
Magnesium-Legierungen	Magnesium alloys	160 - 300	●	●	●		○	●	●
Thermoplaste	Thermoplastics	40 - 70	○	●			●	○	○
Duroplaste	Duroplastics	20 - 40	●	●	●		○	●	●
Graphit	Graphite								
Titanlegierungen, mittelfest	Titanium alloys, medium strength	- 950	○	●	●		○	●	●
Titanlegierungen, hochfest	Titanium alloys, high strength	900 - 1400	○	●	●	●	○	○	○
Nickelbasislegierungen, mittelfest	Nickel based alloys, medium strength	- 950	○	●	●	●	○	○	○
Nickelbasislegierungen, hochwarmfest	Heat resistant nickel based alloys, high strength	900 - 1400	○	○		●		○	○
Hartguss	Chilled cast iron	300 - 600	○	○		●		○	○

Typenbeschreibung Type description

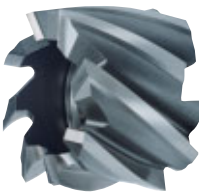
Walzenstirnfräser Shell End Mills





	Walzenstirn-Schlichtfräser Finishing Shell End Mills		DIN	Kat.-Nr. Cat.-No.	TiCN Plus	Seite Page
Typ N 	grob gezahnt ≈ 30° Rechtsdrall 11° Spanwinkel coarse tooth ≈ 30° R.H. spiral 11° rake angle	Für Bau-, Einsatz-, Vergütungsstähle mit normaler Festigkeit bis 1000 N/mm ² sowie kurzspanende NE-Metalle. For structural, case-hardening and heat-treatable steels with normal tensile strength of up to 1000 N/mm ² , also short-chip-producing non-ferrous metals.	1880	1011	1011 C	485
			(841)	1021	●	486
Typ SN 	grob gezahnt ≈ 40° Rechtsdrall 16° Spanwinkel coarse tooth ≈ 40° R.H. spiral 16° rake angle	Für rost- und säurebeständige Stähle, Titanlegierungen. For stainless and acidresistant steels, titanium alloys.	≈ 1880	1013	1013 C	487
Typ NVT 	grob gezahnt ≈ 25° Rechtsdrall 8° Spanwinkel coarse tooth ≈ 25° R.H. spiral 8° rake angle	Zum Schlichten mit hoher Zerspanungsleistung bei gleichzeitig guter Oberfläche von Stählen mit mittlerer bis hoher Festigkeit bis 1100 N/mm ² sowie Titan und Titanlegierungen als auch für kurzspanende NE-Metalle. For finishing with high metal removal rates and yet good surface of steels with medium to high tensile strength up to 1100 N/mm ² as well as for non-ferrous metals producing short broken chips.	1880	1019	1019 C	488
Typ H 	fein gezahnt ≈ 15° Rechtsdrall 7° Spanwinkel fine tooth ≈ 15° R.H. spiral 7° rake angle	Für harte, kurzspanende Werkstoffe wie Grauguß, Messing, Bronze, legierte Werkzeugstähle. For hard, short-chip-producing materials such as cast iron, brass, bronze, alloy tool steels.	1880	1012	●	489

● = Diese Standardausführung ist auch TiCN Plus beschichtet lieferbar
 This standard design is also available TiCN Plus coated

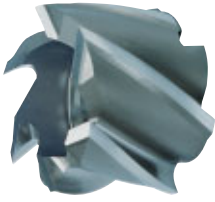
Typenbeschreibung Type description

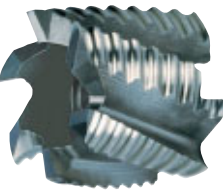
Walzenstirnfräser Shell End Mills

Walzenstirn-Schlichtfräser Finishing Shell End Mills			DIN	Kat.-Nr. Cat.-No.	TiCN Plus	Seite Page
Typ W 	besonders grob gezahnt ≈ 40° Rechtsdrall 22° Spanwinkel extra coarse tooth ≈ 40° R.H. spiral 22° rake angle	Langspanende Werkstoffe, z. B. Alu- und Kupferlegierungen, weiche Stähle, Thermoplaste. Bevorzugt Gleichlauf- fräsen. For long chip curling materials such as aluminium and copper alloys, soft steels, thermoplastics. Preferably, climb milling method is to be applied.	1880	1014	●	489
			(841)	1024	●	490

Walzenstirn-Schrupfräser Roughing Shell End Mills			DIN	Kat.-Nr. Cat.-No.	TiCN Plus	Seite Page
Typ NR  	Schrapp-Kordel- Verzahnung ≈ 30° Rechtsdrall 11° Spanwinkel Knuckle type ≈ 30° R.H. spiral 11° rake angle	Für Werkstoffe mit geringer bis mittlerer Festigkeit bis 900 N/mm ² – vorwiegend langspanend, sowie für Titan und Titanlegierungen. For materials of low to medium tensile strength up to 900 N/mm ² , mostly long- chip-producing, also for titanium and titanium alloys	1880	1016	1016 C	491
			(841)	1026	●	493
Typ NF  	Schrapp-Schlicht- Verzahnung ≈ 30° Rechtsdrall 11° Spanwinkel Truncated type for roughing ≈ 30° R.H. spiral 11° rake angle	Für Werkstoffe mit mittlerer bis hoher Festigkeit bis 1100 N/mm ² , Guß und Gußlegierungen sowie für Titanlegie- rungen. For materials of medium to high tensile strength up to 1100 N/mm ² , also cast iron and alloy cast iron, also for titanium alloys.	1880	1015	1015 C	492
			(841)	1025	●	493

● = Diese Standardausführung ist auch TiCN Plus beschichtet lieferbar
This standard design is also available TiCN Plus coated

mit Längs- und Quernut
NC-gerecht

with standard keyway and drive slot
suitable for NC

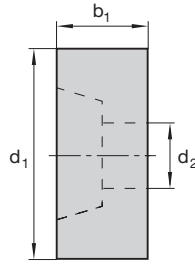

Katalog-Nr.	Cat.-No.	1011	1011 C
Typ	Type	N	
Norm	Standard	DIN 1880	
Drallwinkel	Helix angle	$\approx 30^\circ$	
Beschichtung	Coating	-	TiCN Plus
Werkstoff	Material	HSS-E 909 M 42	HSS-E 909 M 42

d_1 k 12	b_1 k 16	d_2 H 7	z	Ident No.	Ident No.
40	32	16	8	1011285	1011429
50	36	22	8	1011294	1011431
63	40	27	8	1011301	1011433
80	45	27	10	1011310	1011435
100	50	32	10	1011329	1011437

mit Längs- und Quernut
NC-gerecht

with standard keyway and drive slot
suitable for NC

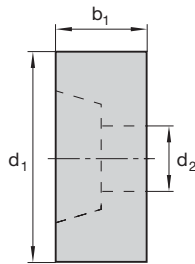

Katalog-Nr.	Cat.-No.	1021
Typ	Type	N
Norm	Standard	früher DIN 841 previously DIN 841
Drallwinkel	Helix angle	≈ 30°
Beschichtung	Coating	-
Werkstoff	Material	HSS-E 909 M 42

d_1 k 12	b_1 k 16	d_2 H 7	z	Ident No.
30 ¹⁾	30	13	6	1014852
35 ¹⁾	35	16	6	1014861
40	40	16	8	1014889
50	50	22	8	1014905
60	60	27	8	1014781
75	35	27	10	1014932
75	75	27	10	1014941
90	35	27	10	1014950

¹⁾ Diese Abmessung wird nur mit Längsnut geliefert
¹⁾ This dimension is only available with standard keyway

Schnittwertempfehlungen ab Seite 494
Cutting data recommendations starting page 494

mit Längs- und Quernut
NC-gerecht

with standard keyway and drive slot
suitable for NC

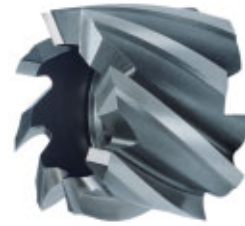
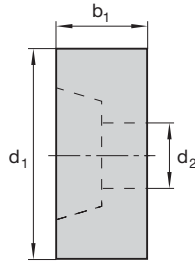

Katalog-Nr.	Cat.-No.	1013	1013 C
Typ	Type	SN	
Norm	Standard	DIN 1880	
Drallwinkel	Helix angle	≈ 40°	
Beschichtung	Coating	-	TiCN Plus
Werkstoff	Material	HSS-E 909 M 42	HSS-E 909 M 42

d ₁ k 12	b ₁ k 16	d ₂ H 7	z	Ident No.	Ident No.
40	32	16	8	1012104	1012202
50	36	22	8	1012113	1012211
63	40	27	8	1012122	1012220
80	45	27	10	1012131	1012239
100	50	32	10	1012140	1012248

mit Längs- und Quernut
hinterschliffen
NC-gerecht

with standard keyway and drive slot
relief ground
suitable for NC

NVT 

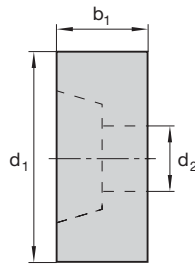

Katalog-Nr.	Cat.-No.	1019	1019 C
Typ	Type	NVT	
Norm	Standard	DIN 1880	
Drallwinkel	Helix angle	≈ 30°	
Beschichtung	Coating	-	TiCN Plus
Werkstoff	Material	HSS-E 909 M 42	HSS-E 909 M 42

d ₁ k 12	b ₁ k 16	d ₂ H 7	z 	Ident No.	Ident No.
40	32	16	8	1014087	1014091
50	36	22	8	1014088	1014092
63	40	27	8	1014089	1014093
80	45	27	10	1014090	1014094

Schnittwertempfehlungen ab Seite 494
Cutting data recommendations starting page 494

mit Längs- und Quernut
NC-gerecht

with standard keyway and drive slot
suitable for NC

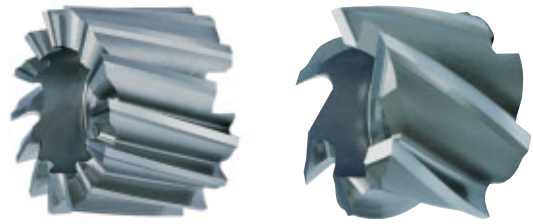
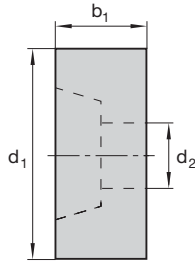

Katalog-Nr.	Cat.-No.	1012	1014
Typ	Type	H	W
Norm	Standard	DIN 1880	
Drallwinkel	Helix angle	≈ 15°	≈ 40°
Beschichtung	Coating	-	
Werkstoff	Material	HSS-E 909 M 42	HSS-E 909 M 42

d_1 k 12	b_1 k 16	d_2 H 7	z	Ident No.	Ident No.
40	32	16	6		1012480
50	36	22	6		1012499
63	40	27	6		1012505
80	45	27	6		1012514
100	50	32	8		1012523
40	32	16	10	1011882	
50	36	22	12	1011891	
63	40	27	14	1011908	
80	45	27	16	1011917	
100	50	32	-	-	

Schnittwertempfehlungen ab Seite 494
Cutting data recommendations starting page 494

mit Längs- und Quernut
NC-gerecht

with standard keyway and drive slot
suitable for NC

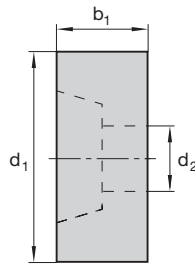

Katalog-Nr.	Cat.-No.	1024
Typ	Type	W
Norm	Standard	früher DIN 841 previously DIN 841
Drallwinkel	Helix angle	≈ 40°
Beschichtung	Coating	-
Werkstoff	Material	HSS-E 909 M 42

d ₁ k 12	b ₁ k 16	d ₂ H 7	z	Ident No.
40	40	16	6	1017252
50	50	22	6	1017270
60	60	27	6	1017298
75	35	27	6	1017305
75	75	27	6	1017314

Schnittwertempfehlungen ab Seite 494
Cutting data recommendations starting page 494

mit Längs- und Quernut
hinterschliffen
NC-gerecht

with standard keyway and drive slot
relief ground
suitable for NC

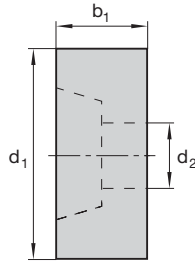

Katalog-Nr.	Cat.-No.	1016	1016 C
Typ	Type	NR	
Norm	Standard	DIN 1880	
Drallwinkel	Helix angle	≈ 30°	
Beschichtung	Coating	-	TiCN Plus
Werkstoff	Material	HSS-E EMo5Co5	HSS-E 909 M 42

d ₁ k 12	b ₁ k 16	d ₂ H 7	z	Ident No.	Ident No.
40	32	16	6	1013611	1014004
50	36	22	6	1013620	1014013
63	40	27	8	1013639	1014022
80	45	27	8	1013648	1014031
100	50	32	10	1013657	1014040
125	56	40	12	1013666	1121565
160	63	50	14	1013675	1121566

mit Längs- und Quernut
hinterschliffen
NC-gerecht

with standard keyway and drive slot
relief ground
suitable for NC

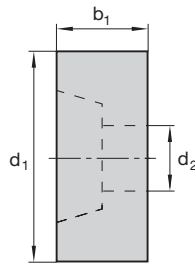

Katalog-Nr.	Cat.-No.	1015	1015 C
Typ	Type	NF	
Norm	Standard	DIN 1880	
Drallwinkel	Helix angle	≈ 30°	
Beschichtung	Coating	-	TiCN Plus
Werkstoff	Material	HSS-E EMo5Co5	HSS-E 909 M 42

d ₁ k 12	b ₁ k 16	d ₂ H 7	z	Ident No.	Ident No.
40	32	16	6	1013014	1013309
50	36	22	6	1013023	1013318
63	40	27	8	1013032	1013327
80	45	27	8	1013041	1013336
100	50	32	10	1013050	1013345
125	56	40	12	1013069	1121568
160	63	50	14	1013078	1121569

	Werkstoff	Material	R_m/UTS (N/mm²)	HSS-E TiCN Plus v_c m/min	f_z mm	Leistungsfaktor Efficiency factor LF
Blue	Unlegierter Baustahl	Plain carbon steel	-700	60	0,2	20
	Automatenstahl	Free cutting steel	-700	60	0,2	20
	Baustahl	Structural alloy steel	500-950	50	0,15	18
	Vergütungsstahl, mittelfest	Heat-treatable steel, medium strength	500-950	50	0,15	18
	Stahlguss	Cast steel	-950	45	0,12	18
	Einsatzstahl	Case hardening steel	-950	55	0,18	18
	Rost- und säurebeständiger Stahl, ferritisch, martensitisch	Stainless steel, ferritic, martensitic	500-950	30	0,15	16
	Vergütungsstahl, hochfest	Heat-treatable steel, high strength	950-1400	35	0,12	13
	Nitrierstahl, vergütet	Nitriding steel	950-1400	35	0,12	15
	Werkzeugstahl	Tool steel	950-1400	35	0,12	13
	Yellow	Rost- und säurebeständiger Stahl, austenitisch	Stainless steel, austenitic	500-950	40	0,15
Martensitaushärtbarer Stahl		Maraging steel	500-950	40	0,15	15
Red	Grauguss	Grey cast iron	100-400 (120-260 HB)	60	0,18	30
	Legierter Grauguss	Alloyed grey cast iron	150-250 (160-230 HB)	50	0,18	25
	Sphäroguss	Nodular cast iron	400-800 (120-310 HB)	50	0,18	24
	Temperguss	Malleable cast iron	350-700 (150-280 HB)	70	0,18	30
Green	Rein-Metalle, weich	Pure metals, soft	-500	220	0,16	30
	Aluminium-Legierungen, langspanend	Aluminium alloys, long chipping	-550	400	0,15	30
	Aluminium-Legierungen, kurzspanend	Aluminium alloys, short chipping	-400	120	0,15	25
	Kupfer-Legierungen, langspanend	Copper alloys, long chipping	300-700	100	0,18	30
	Kupfer-Legierungen, kurzspanend	Copper alloys, short chipping	-500	75	0,14	35
	Magnesium-Legierungen	Magnesium alloys	160-300	350	0,14	25
	Thermoplaste	Thermoplastics	40-70	160	0,15	25
	Duroplaste	Duroplastics	20-40	100	0,12	25
Graphit	Graphite					
Orange	Titan-Legierungen, mittelfest	Titanium alloys, medium strength	-950	25 ¹⁾	0,11	18
	Titan-Legierungen, hochfest	Titanium alloys, high strength	900-1400	12 ¹⁾	0,08	16
	Nickelbasis-Legierungen, mittelfest	Nickel based alloys, medium strength	-950	30	0,12	18
	Nickel-Basis-Legierungen, hochwarmfest	Heat resistant nickel based alloys, high strength	900-1400	12	0,1	14
Grey	Hartguss	Chilled cast iron	300-600	20	0,08	25

¹⁾ Empfehlung: Fräser unbeschichtet einsetzen mit diesen Werten

¹⁾ Recommended: use uncoated end mills with these values

Drehzahl Speed $n = \frac{v_c \cdot 1000}{\pi \cdot d_1} \cdot f_1$ v_c Tab. Seite 494 Page 494	Vorschubgeschwindigkeit Feed rate $v_f = f_z \cdot z \cdot n \cdot f_2$ f_z Tab. Seite 494 Page 494	a_e = Schnittbreite in mm Width of cut in mm a_p = Schnitttiefe in mm Depth of cut in mm d_1 = Durchmesser in mm Cutter diameter in mm f_1 = Korrekturfaktor für v_c Correction factor v_c f_2 = Korrekturfaktor für v_f Correction factor v_f f_z = Vorschub pro Zahn in mm Feed per tooth in mm LF = Leistungsfaktor in $\text{cm}^3/\text{min}/\text{kW}$ Efficiency factor in $\text{cm}^3/\text{min}/\text{kW}$ n = Drehzahl in min^{-1} Speed in min^{-1} P_e = Spindelleistung in kW Drive power in kW Q = Spanvolumen in cm^3/min Chip volume in cm^3/min v_c = Schnittgeschwindigkeit in m/min Cutting speed in m/min v_f = Vorschubgeschwindigkeit in mm/min Feed rate in mm/min z = Anzahl der Schneiden No. of teeth
Spanvolumen Chip volume $Q = \frac{a_e \cdot a_p \cdot v_f}{1000}$	Spindelleistung Drive power $P_e \approx \frac{Q}{LF}$	

Schnittgeschwindigkeitskorrektur f_1 Cutting speed correction factor f_1

	unbeschichtet uncoated	TiN	TiCN	TiCN Plus	AL Plus
$f_1 =$	0,6	0,8	1	1	1

Vorschubkorrektur f_2 Cutting speed correction factor f_2

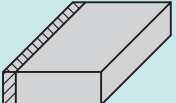
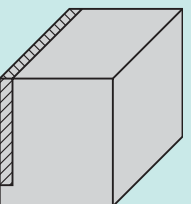
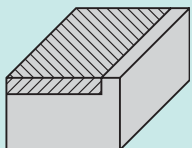
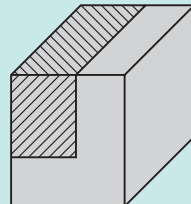
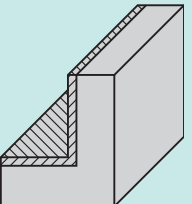
					
	$a_e < 0,1 \cdot d_1$ –	$a_e < 0,1 \cdot d_1$ –	$a_e < 0,75 \cdot d_1$ $a_p < 0,1 \cdot b_1$	$a_e > 0,2 \cdot d_1$ $a_p > 0,1 \cdot b_1$	$a_e < 0,1 \cdot d_1$ $a_p < 0,1 \cdot b_1$
Schrappfräser Roughing Milling Cutters $f_2 =$	1	1	0,6	0,5	–
Schlichtfräser Finishing Milling Cutters $f_2 =$	0,8	0,8	0,5	–	0,5



Scheibenfräser und Kreissägeblätter





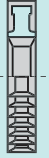
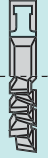

Side and Face Milling Cutters and Metal Slitting Saws

Auswahlübersichten Selection tables	498
Typenbeschreibungen Type descriptions	500
Scheibenfräser Side Milling Cutters	502
Metallkreissägeblätter Metal Slitting Saws	516
Schnittwertempfehlungen Cutting data recommendations	529

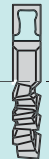
Auswahlübersicht Selection table

Scheibenfräser und Kreissägeblätter Side Milling Cutters and Metal Slitting Saws

					
			Scheibenfräser Side Milling Cutters		
			N		
Typ Type			geradeverzahnt schmal straight tooth	kreuzverzahnt schmal staggered tooth	
Ausführung Design					
Seite Page			510	512	
Werkstoff	Material	R _m /UTS (N/mm ²)			
Unlegierter Baustahl	Plain carbon steel	-700	●	●	
Automatenstahl	Free cutting steel	-700	●	●	
Baustahl	Structural alloy steel	500-950	●	●	
Vergütungsstahl, mittelfest	Heat-treatable steel, medium strength	500-950	●	●	
Stahlguss	Cast steel	-950	●	●	
Einsatzstahl	Case hardening steel	-950	●	●	
Rost- und säurebeständiger Stahl, ferritisch, martensitisch	Stainless steel, ferritic, martensitic	500-950	●	●	
Vergütungsstahl, hochfest	Heat-treatable steel, high strength	950-1400	○	○	
Nitrierstahl, vergütet	Nitriding steel	950-1400	○	○	
Werkzeugstahl (bis 45 HCR)	Tool steel	950-1400	○	○	
Rost- und säurebeständiger Stahl, austenitisch	Stainless steel, austenitic	500-950	●	●	
Martensitaushärtbarer Stahl	Maraging steel	500-950	●	●	
Grauguss	Grey cast iron	100-400 (120-260 HB)	●	●	
Legierter Grauguss	Alloyed grey cast iron	150-250 (160-230 HB)	●	●	
Sphäroguss	Nodular cast iron	400-800 (120-310 HB)	●	●	
Temperguss	Malleable cast iron	350-700 (150-280 HB)	●	●	
Rein-Metalle, weich	Pure metals, soft	-500	○	○	
Aluminium-Legierungen, langspanend	Aluminium alloys, long chipping	-550	○	○	
Aluminium-Legierungen, kurzspanend	Aluminium alloys, short chipping	-400	●	●	
Kupfer-Legierungen, langspanend	Copper alloys, long chipping	300-700	○	○	
Kupfer-Legierungen, kurzspanend	Copper alloys, short chipping	-500	●	●	
Magnesium-Legierungen	Magnesium alloys	150-300	●	●	
Thermoplaste	Thermoplastics	40-70	○	○	
Duroplaste	Duroplastics	20-40	●	●	
Titan-Legierungen, mittelfest	Titanium alloys, medium strength	-950			
Titan-Legierungen, hochfest	Titanium alloys, high strength	900-1400	○	○	
Nickelbasis-Legierungen, mittelfest	Nickel based alloys, medium strength	-950	○	○	
Nickel-Basis-Legierungen, hochwarmfest	Heat resistant nickel based alloys, high strength	900-1400			
Hartguss	Chilled cast iron	300-600			

						
	Scheibenfräser Side Milling Cutters					Kreissägeblätter Slitting Saws
	N		H			N
	kreuzverzahnt staggered tooth	gekuppelt und verstellbar interlocking and adjustable	geradeverzahnt straight tooth	kreuzverzahnt schmal staggered tooth	kreuzverzahnt staggered tooth	-
	504	515	502	514	507	516
	●	●	○	○	○	●
	●	●	○	○	○	●
	●	●	○	○	○	●
	●	●	○	○	○	●
	●	●	○	○	○	●
	●	●	○	○	○	●
	○	○	●	●	●	○
	○	○	●	●	●	○
	○	○	●	●	●	○
	●	●				●
	●	●				●
	●	●	●	●	●	●
	●	●	●	●	●	●
	●	●				●
	●	●				●
	○	○				○
	○	○				○
	●	●				●
	○	○				○
	●	●				●
	●	●				●
	○	○				○
	●	●	●	●	●	●
	○	○	●	●	●	○
	○	○	●	●	●	○
			●	●	●	
			●	●	●	



Typenbeschreibung Type description

Scheibenfräser und Kreissägeblätter Side and Face Milling Cutters and Metal Slitting Saws

				DIN (WN=Werknorm Fette Standard)	Kat.-Nr. Cat.-No.	Seite Page
Typ N 	Scheibenfräser gefräste Ausführung mit Fasenanschliff auf 3 Seiten schneidend Side Milling Cutters machine milled design with relieved land cutting on 3 sides	Kreuzverzahnt staggered tooth bis $\varnothing 100 \approx 12^\circ$ $\geq \varnothing 125 \approx 15^\circ$ DIN 885 A	HSS-E Werkzeuge: Zur Bearbeitung von Werkstoffen bis ca. 1200 N/mm ² Festigkeit. HSS-E tools: For machining of materials up to 1200 N/mm ² tensile strength.	885 A	1211	504
Typ H 	Scheibenfräser gefräste Ausführung mit Fasenanschliff auf 3 Seiten schneidend Side Milling Cutters machine milled design with relieved land cutting on 3 sides	Geradeverzahnt straight tooth DIN 885 B Spanwinkel rake angle 7°	HSS-E Werkzeuge: Zur Bearbeitung von Werkstoffen bis ca. 1200 N/mm ² Festigkeit. HSS-E tools: For machining of materials up to 1200 N/mm ² tensile strength.	885 B	1202	502
Typ H 	Scheibenfräser gefräste Ausführung mit Fasenanschliff auf 3 Seiten schneidend Side Milling Cutters machine milled design with relieved land cutting on 3 sides	Kreuzverzahnt $\approx 8^\circ$ staggered tooth DIN 885 A Spanwinkel rake angle 7°	HSS-E Werkzeuge: Zur Bearbeitung von Werkstoffen bis ca. 1200 N/mm ² Festigkeit. HSS-E tools: For machining of materials up to 1200 N/mm ² tensile strength.	885 A	1212	507
Typ N 	Nutenfräser – gekuppelt und verstellbar, gefräste Ausführung mit Fasenschliff, $\approx 12^\circ$ kreuzverzahnt, auf 3 Seiten schneidend, Spanwinkel 11° , DIN 1891 B Slotting Cutters – interlocking and adjustable, machine milled design with relieved land, $\approx 12^\circ$ staggered tooth, cutting on 3 sides, rake angle 11°			1891 B	1266	515

Typenbeschreibung Type description

Scheibenfräser und Kreissägeblätter Side and Face Milling Cutters and Metal Slitting Saws

			DIN (WN=Werknorm Fette Standard)	Kat.-Nr. Cat.-No.	Seite Page		
Typ N 	Scheibenfräser schmal, gefräste Ausführung mit Fasenschliff DIN 1834 B und Fette Werknorm, Typ N, # 1203 geradeverzahnt.	Side Milling Cutters, machine milled design with relieved land, DIN 1834 B and Fette standard, Type N # 1203 straight tooth.	1834 B	1203	510		
Typ N 	Scheibenfräser schmal, gefräste Ausführung mit Fasenschliff DIN 1834 A und Fette Werknorm, Typ N # 1213 $\approx 14^\circ$ kreuzverzahnt.	Side Milling Cutters, machine milled design with relieved land, DIN 1834 A and Fette standard, Type N # 1213 $\approx 14^\circ$ staggered tooth.	1834 A	1213	512		
Typ H 	Scheibenfräser schmal, gefräste Ausführung mit Fasenschliff DIN 1834 A und Fette Werknorm, Typ H, # 1223 kreuzverzahnt, grob. Für Stähle bis 1200 N/mm ² Festigkeit und hochfeste NE-Metalle wie Si-haltiges Aluminium und Titan.	Side Milling Cutters, machine milled design with relieved land, DIN 1834 A and Fette standard, Type H # 1223 staggered teeth, coarse. For tough steels and non-ferrous materials up to 1200 N/mm ² such as aluminium containing a high percentage of Si and titanium.	1834 A	1223	514		
	Metallkreissägeblätter Metal Slitting Saws		Zahnform Tooth form	A	1837	1281	517
			Zahnform Tooth form	B+C	1838	1282 1283	521
	Für Eisele Kreissägemaschinen For Eisele sawing machines		Zahnform Tooth form	BW	WN	1291	516

auf 3 Seiten schneidend
cutting on three sides

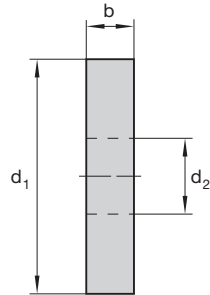

Katalog-Nr.	Cat.-No.	1202
Typ	Type	H
Norm	Standard	DIN 885 B
Drallwinkel	Helix angle	geradeverzahnt straight face
Werkstoff	Material	HSS-E EMo5Co5

d ₁ k 14	b k 11	d ₂ H 7	z	Ident No.
50	4	16	14	1177685
50	5	16	14	1177687
50	6	16	14	1177689
50	8	16	14	1177691
50	10	16	14	1177693
63	5	22	16	1177697
63	6	22	16	1177699
63	8	22	16	1177701
63	10	22	16	1177703
63	12	22	16	1177705
63	14	22	16	1177707
63	16	22	16	1177709
63	18	22	16	1177711
80	6	22	18	1177715
80	8	22	18	1177717
80	10	22	18	1177719
80	14	22	18	1177723
80	16	22	18	1177725
80	5	27	18	1177729
80	6	27	18	1177731
80	8	27	18	1177733
80	16	27	18	1177741
80	20	27	18	1177743
100	6	27	20	1177745
100	8	27	20	1177747
100	10	27	20	1177749
100	14	27	20	1177753
100	16	27	20	1177755
100	18	27	20	1177757
100	20	27	20	1177759
100	25	27	20	1177761
100	8	32	20	1177765
100	10	32	20	1177767
100	12	32	20	1177769
100	14	32	20	1177771
100	16	32	20	1177773
100	18	32	20	1177775
100	20	32	20	1177777

Ø 80/22, gegenüber DIN als Fette-Hausnorm erweitert
Ø 80/22 opposed to DIN as Fette Standard extended

Schnittwertempfehlungen ab Seite 529
Cutting data recommendations starting page 529



**auf 3 Seiten schneidend
cutting on three sides**

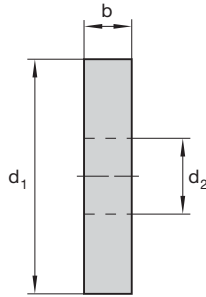

Katalog-Nr.	Cat.-No.	1202
Typ	Type	H
Norm	Standard	DIN 885 B
Drallwinkel	Helix angle	geradeverzahnt straight face
Werkstoff	Material	HSS-E EMo5Co5

d ₁ k 14	b k 11	d ₂ H 7	z ⚙	Ident No.
100	25	32	20	1177779
125	8	32	20	1177781
125	10	32	20	1177783
125	12	32	20	1177785
125	14	32	20	1177787
125	16	32	20	1177789
125	18	32	22	1177791
125	20	32	22	1177793
125	25	32	22	1177795
150	8	32	24	1177799
150	10	32	24	1177801
150	12	32	24	1177803
150	14	32	24	1177805
150	20	32	24	1177809
160	8	40	24	1177811
160	10	40	24	1177813
160	16	40	24	1177819
160	18	40	24	1177821
160	20	40	24	1177823
200	10	40	32	1177827
200	12	40	32	1177829
200	14	40	32	1177831
200	18	40	32	1177835
200	20	40	32	1177837

Schnittwertempfehlungen ab Seite 529
Cutting data recommendations starting page 529

auf 3 Seiten schneidend
cutting on three sides

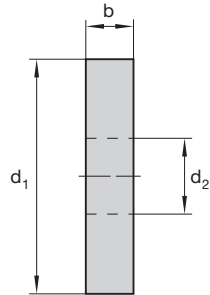

Katalog-Nr.	Cat.-No.	1211
Typ	Type	N
Norm	Standard	DIN 885 A
Drallwinkel	Helix angle	≤ Ø 100 ≈ 12° kreuzverzahnt staggered tooth ≥ Ø 125 ≈ 15° kreuzverzahnt staggered tooth
Werkstoff	Material	HSS-E EMo5Co5

d ₁ k 14	b k 11	d ₂ H 7	z	Ident No.
50	4	16	10	1077473
50	5	16	10	1077482
50	6	16	10	1077491
50	8	16	10	1077507
50	10	16	10	1077516
63	4	22	12	1077525
63	5	22	12	1077534
63	6	22	12	1077543
63	8	22	12	1077552
63	10	22	12	1077561
63	12	22	12	1077570
63	14	22	12	1077589
80	5	22	14	1077614
80	6	22	14	1077623
80	8	22	14	1077632
80	10	22	14	1077641
80	12	22	14	1077650
80	16	22	14	1077678
80	18	22	14	1077687
80	20	22	14	1077696
80	5	27	14	1077703
80	6	27	14	1077712
80	8	27	14	1077721
80	10	27	14	1077730
80	12	27	14	1077749
80	14	27	14	1077758
80	16	27	14	1077767
80	18	27	14	1077776
80	20	27	14	1077785
100	6	27	16	1077794
100	8	27	16	1077801
100	10	27	16	1077810
100	12	27	16	1077829
100	14	27	16	1077838
100	16	27	16	1077847
100	18	27	16	1077856
100	20	27	16	1077865
100	22	27	16	1077874

Ø 80/22, gegenüber DIN als Fette-Hausnorm erweitert
Ø 80/22 opposed to DIN as Fette Standard extended

Schnittwertempfehlungen ab Seite 529
Cutting data recommendations starting page 529



auf 3 Seiten schneidend
cutting on three sides

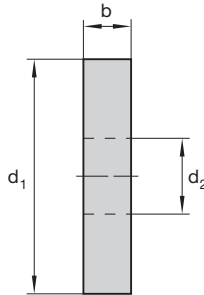

Katalog-Nr.	Cat.-No.	1211
Typ	Type	N
Norm	Standard	DIN 885 A
Drallwinkel	Helix angle	≦ Ø 100 ≈ 12° kreuzverzahnt staggered tooth ≧ Ø 125 ≈ 15° kreuzverzahnt staggered tooth
Werkstoff	Material	HSS-E EMo5Co5

d ₁ k 14	b k 11	d ₂ H 7	z ⚙	Ident No.
100	25	27	16	1077883
100	6	32	16	1077892
100	8	32	16	1077909
100	10	32	16	1077918
100	12	32	16	1077927
100	14	32	16	1077936
100	16	32	16	1077945
100	18	32	16	1077954
100	20	32	16	1077963
100	22	32	16	1077972
100	25	32	16	1077981
125	8	32	16	1078007
125	10	32	16	1078016
125	12	32	16	1078025
125	14	32	16	1078034
125	16	32	16	1078043
125	18	32	16	1078052
125	20	32	16	1078061
125	22	32	16	1078070
125	25	32	16	1078089
125	28	32	16	1078098
150	6	32	18	1078105
150	8	32	18	1078114
150	10	32	18	1078123
150	12	32	18	1078132
150	16	32	18	1078150
150	18	40	18	1078169
150	20	40	18	1078178
150	24	40	18	1078196
150	26	40	18	1078203
150	28	40	18	1078212
160	8	40	18	1078221
160	10	40	18	1078230
160	12	40	18	1078249
160	14	40	18	1078258
160	16	40	18	1078267
160	18	40	18	1078276
160	20	40	18	1078285

Schnittwertempfehlungen ab Seite 529
Cutting data recommendations starting page 529

auf 3 Seiten schneidend
cutting on three sides

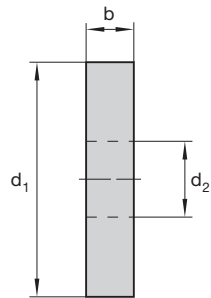

Katalog-Nr.	Cat.-No.	1211
Typ	Type	N
Norm	Standard	DIN 885 A
Drallwinkel	Helix angle	≤ Ø 100 ≈ 12° kreuzverzahnt staggered tooth ≥ Ø 125 ≈ 15° kreuzverzahnt staggered tooth
Werkstoff	Material	HSS-E EMo5Co5

d ₁ k 14	b k 11	d ₂ H 7	z ⚙	Ident No.
160	22	40	18	1078294
160	25	40	18	1078301
160	28	40	18	1078310
160	32	40	18	1078329
200	8	40	22	1078445
200	10	40	22	1078454
200	12	40	22	1078463
200	14	40	22	1078472
200	16	40	22	1078481
200	18	40	22	1078490
200	20	40	22	1078506
200	22	40	22	1078515
200	25	40	22	1078524
200	28	40	22	1078533
200	32	40	22	1078542
250	10	50	32	1078551
250	12	50	32	1078560
250	14	50	32	1078579
250	16	50	32	1078588
250	20	50	26	1078604
250	28	50	26	1078622

Schnittwertempfehlungen ab Seite 529
Cutting data recommendations starting page 529

auf 3 Seiten schneidend
cutting on three sides

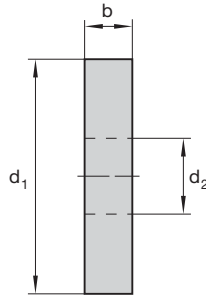

Katalog-Nr.	Cat.-No.	1212
Typ	Type	H
Norm	Standard	DIN 885 A
Drallwinkel	Helix angle	≈ 8° kreuzverzahnt staggered tooth
Werkstoff	Material	HSS-E EMo5Co5

d ₁ k 14	b k 11	d ₂ H 7	z ⚙	Ident No.
50	4	16	16	1177845
50	5	16	16	1177847
50	6	16	16	1177849
50	8	16	16	1177851
50	10	16	16	1177853
63	4	22	18	1080423
63	5	22	18	1080432
63	6	22	18	1080441
63	8	22	18	1080450
63	10	22	18	1080469
63	12	22	18	1080478
63	14	22	18	1080487
63	16	22	18	1080496
63	18	22	18	1080502
80	5	22	20	1080511
80	6	22	20	1080520
80	8	22	20	1080539
80	10	22	20	1080548
80	12	22	20	1080557
80	5	27	20	1080600
80	6	27	20	1080619
80	8	27	20	1080628
80	10	27	20	1080637
80	12	27	20	1080646
80	14	27	20	1080655
80	16	27	20	1080664
80	18	27	20	1080673
80	20	27	20	1080682
80	14	22	20	1177855
80	16	22	20	1177857
80	18	22	20	1177859
80	20	22	20	1177861
100	6	32	24	1080799
100	8	32	24	1080806
100	10	32	24	1080815
100	12	32	24	1080824
100	14	32	24	1080833
100	16	32	24	1080842

Ø 80/22, gegenüber DIN als Fette-Hausnorm erweitert
Ø 80/22 opposed to DIN as Fette Standard extended

Schnittwertempfehlungen ab Seite 529
Cutting data recommendations starting page 529

auf 3 Seiten schneidend
cutting on three sides

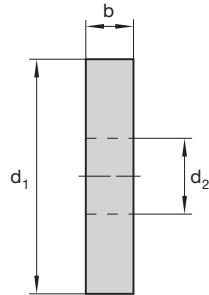

Katalog-Nr.	Cat.-No.	1212
Typ	Type	H
Norm	Standard	DIN 885 A
Drallwinkel	Helix angle	≈ 8° kreuzverzahnt staggered tooth
Werkstoff	Material	HSS-E EMO5Co5

d ₁ k 14	b k 11	d ₂ H 7	z	Ident No.
100	18	32	24	1080851
100	20	32	24	1080860
100	22	32	24	1080879
100	25	32	24	1080888
100	6	27	24	1177863
100	8	27	24	1177865
100	10	27	24	1177867
100	12	27	24	1177869
100	14	27	24	1177871
100	16	27	24	1177873
100	18	27	24	1177875
100	20	27	24	1177877
100	22	27	24	1177879
100	25	27	24	1177881
125	8	32	26	1080904
125	10	32	26	1080913
125	12	32	26	1080922
125	14	32	26	1080931
125	16	32	26	1080940
125	18	32	26	1080959
125	20	32	26	1080968
125	22	32	26	1080977
125	25	32	26	1080986
125	28	32	26	1080995
160	8	40	28	1081128
160	10	40	28	1081137
160	12	40	28	1081146
160	14	40	28	1081155
160	16	40	28	1081164
160	18	40	28	1081173
160	20	40	28	1081182
160	22	40	28	1081191
160	25	40	28	1081208
160	28	40	28	1081217
160	32	40	28	1081226
200	8	40	34	1081342
200	10	40	34	1081351
200	12	40	34	1081360

Schnittwertempfehlungen ab Seite 529
Cutting data recommendations starting page 529

auf 3 Seiten schneidend
cutting on three sides

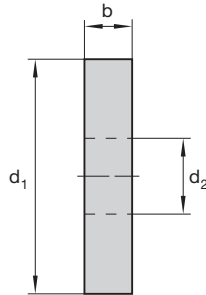

Katalog-Nr.	Cat.-No.	1212
Typ	Type	H
Norm	Standard	DIN 885 A
Drallwinkel	Helix angle	≈ 8° kreuzverzahnt staggered tooth
Werkstoff	Material	HSS-E EMo5Co5

d ₁ k 14	b k 11	d ₂ H 7	z	Ident No.
200	14	40	34	1081379
200	16	40	34	1081388
200	18	40	34	1081397
200	20	40	34	1081404
200	22	40	34	1081413
200	25	40	34	1081422
200	28	40	34	1081431
200	32	40	34	1081440
250	10	50	48	1177891
250	12	50	48	1177893
250	14	50	40	1177895
250	16	50	40	1177897
250	20	50	40	1177901
250	25	50	40	1177903

Schnittwertempfehlungen ab Seite 529
Cutting data recommendations starting page 529

auf 3 Seiten schneidend
cutting on three sides

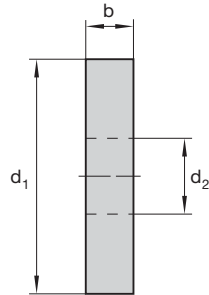

Katalog-Nr.	Cat.-No.	1203
Typ	Type	N
Norm	Standard	DIN 1834 B
Drallwinkel	Helix angle	geradeverzahnt straight tooth
Werkstoff	Material	HSS-E EMO5Co5

d ₁ js 16	b k 11	d ₂ H 7	z	Ident No.
63	1,6	22	32	1074013
63	2	22	32	1074016
63	2,5	22	32	1074019
63	3	22	32	1074022
63	4	22	32	1074025
63	5	22	32	1074028
80 ¹⁾	1,6	22	36	1074032
80 ¹⁾	2	22	36	1074035
80 ¹⁾	2,5	22	36	1074041
80 ¹⁾	3	22	36	1074044
80 ¹⁾	4	22	36	1074050
80 ¹⁾	5	22	36	1074053
80	1,6	27	36	1074059
80	2	27	36	1074062
80	2,5	27	36	1074068
80	3	27	36	1074071
80	4	27	36	1074077
80	5	27	36	1074080
100 ¹⁾	1,6	22	40	1074086
100 ¹⁾	2	22	40	1074089
100 ¹⁾	2,5	22	40	1074095
100 ¹⁾	3	22	40	1074098
100 ¹⁾	4	22	40	1074101
100 ¹⁾	5	22	40	1074104
100	1,6	32	40	1074107
100	2	32	40	1074112
100	2,5	32	40	1074115
100	3	32	40	1074121
100	4	32	40	1074124
100	5	32	40	1074130
100	6	32	40	1074133
100	8	32	32	1074139
125 ¹⁾	2	22	44	1074142
125 ¹⁾	2,5	22	44	1074148
125 ¹⁾	3	22	44	1074151
125 ¹⁾	4	22	44	1074157
125 ¹⁾	5	22	44	1074160
125 ¹⁾	6	22	44	1074166

¹⁾ Gegenüber DIN als Fette-Hausnorm erweitert
¹⁾ Compared with DIN as Fette Standard extended

Schnittwertempfehlungen ab Seite 529
Cutting data recommendations starting page 529

auf 3 Seiten schneidend
cutting on three sides

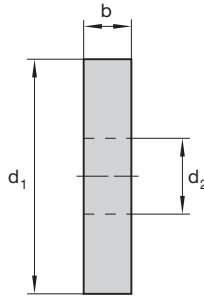

Katalog-Nr.	Cat.-No.	1203
Typ	Type	N
Norm	Standard	DIN 1834 B
Drallwinkel	Helix angle	geradeverzahnt straight tooth
Werkstoff	Material	HSS-E EMo5Co5

d ₁ js 16	b k 11	d ₂ H 7	z ⚙	Ident No.
125	2	32	44	1074169
125	2,5	32	44	1074175
125	3	32	44	1074178
125	4	32	44	1074184
125	5	32	44	1074187
125	6	32	44	1074193
125	8	32	36	1074196
125	10	32	36	1074199
160 ¹⁾	3	32	52	1074202
160 ¹⁾	4	32	52	1074205
160 ¹⁾	5	32	52	1074210
160 ¹⁾	6	32	52	1074213
160	2	40	52	1074219
160	2,5	40	52	1074222
160	3	40	52	1074228
160	4	40	52	1074231
160	5	40	52	1074237
160	6	40	52	1074240
160	8	40	40	1074246
160	10	40	40	1074249
160	12	40	40	1074255

¹⁾ Gegenüber DIN als Fette-Hausnorm erweitert
¹⁾ Compared with DIN as Fette Standard extended

Schnittwertempfehlungen ab Seite 529
Cutting data recommendations starting page 529

auf 3 Seiten schneidend
cutting on three sides

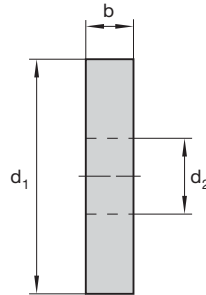

Katalog-Nr.	Cat.-No.	1213
Typ	Type	N
Norm	Standard	≈ DIN 1834 A
Drallwinkel	Helix angle	≈ 14° kreuzverzahnt staggered tooth
Werkstoff	Material	HSS-E EMo5Co5

d ₁ js 16	b k 11	d ₂ H 7	z	Ident No.
63	1,6	22	28	1082011
63	2	22	28	1082013
63	2,5	22	28	1082015
63	3	22	28	1082017
63	4	22	28	1082021
63	5	22	28	1082025
80 ¹⁾	1,6	22	32	1082024
80 ¹⁾	2	22	32	1082026
80 ¹⁾	2,5	22	32	1082028
80 ¹⁾	3	22	32	1082030
80 ¹⁾	4	22	32	1082032
80	1,6	27	32	1082031
80	2	27	32	1082033
80	2,5	27	32	1082035
80	3	27	32	1082037
80	4	27	32	1082041
80	5	27	32	1082049
100 ¹⁾	1,6	22	36	1082050
100 ¹⁾	2	22	36	1082052
100 ¹⁾	2,5	22	36	1082054
100 ¹⁾	3	22	36	1082058
100 ¹⁾	4	22	36	1082060
100 ¹⁾	5	22	36	1082062
100	1,6	32	36	1082053
100	2	32	36	1082055
100	2,5	32	36	1082057
100	3	32	36	1082059
100	4	32	36	1082063
100	5	32	36	1082069
100	6	32	36	1082071
100	8	32	28	1082073
125 ¹⁾	2	22	40	1082082
125 ¹⁾	2,5	22	40	1082084
125 ¹⁾	3	22	40	1082086
125 ¹⁾	4	22	40	1082088
125 ¹⁾	5	22	40	1082090
125 ¹⁾	6	22	40	1082094
125	2	32	40	1082077

¹⁾ Gegenüber DIN als Fette-Hausnorm erweitert
¹⁾ Compared with DIN as Fette Standard extended

Schnittwertempfehlungen ab Seite 529
Cutting data recommendations starting page 529



auf 3 Seiten schneidend
cutting on three sides

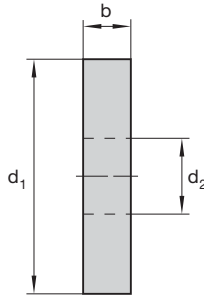

Katalog-Nr.	Cat.-No.	1213
Typ	Type	N
Norm	Standard	≈ DIN 1834 A
Drallwinkel	Helix angle	≈ 14° kreuzverzahnt staggered tooth
Werkstoff	Material	HSS-E EMo5Co5

d ₁ js 16	b k 11	d ₂ H 7	z	Ident No.
125	2,5	32	40	1082079
125	3	32	40	1082081
125	4	32	40	1082087
125	5	32	40	1082089
125	6	32	40	1082093
125	8	32	32	1082095
125	10	32	32	1082097
160 ¹⁾	3	32	48	1082112
160 ¹⁾	4	32	48	1082114
160 ¹⁾	5	32	48	1082116
160	2,5	40	48	1082099
160	3	40	48	1082101
160	4	40	48	1082103
160	5	40	48	1082105
160	6	40	48	1082107
160	8	40	36	1082111
160	10	40	36	1082113
200 ¹⁾	3	32	56	1082138
200 ¹⁾	4	32	56	1082140
200 ¹⁾	5	32	56	1082142
200 ¹⁾	6	32	56	1082144
200	3	40	56	1082117
200	4	40	56	1082119
200	5	40	56	1082121
200	6	40	56	1082123
200	8	40	40	1082125
200	10	40	40	1082129
200	12	40	40	1082131
250	3	40	64	1082135
250	4	40	64	1082137
250	5	40	64	1082139
250	6	40	64	1082141
250	8	40	50	1082143
250	10	40	50	1082147

¹⁾ Gegenüber DIN als Fette-Hausnorm erweitert
¹⁾ Compared with DIN as Fette Standard extended

Schnittwertempfehlungen ab Seite 529
Cutting data recommendations starting page 529

auf 3 Seiten schneidend
cutting on three sides

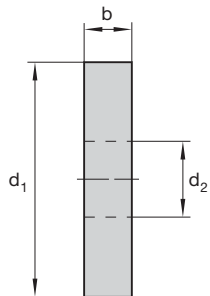

Katalog-Nr.	Cat.-No.	1223
Typ	Type	H
Norm	Standard	≈ DIN 1834 A
Drallwinkel	Helix angle	≈ 25° kreuzverzahnt, grob staggered tooth, coarse
Werkstoff	Material	HSS-E EMO5Co5

d ₁ js 16	bk 11	d ₂ H 7	z ⚙	Ident No.
63	1,6	22	16	1120308
63	2	22	16	1120309
63	2,5	22	16	1120310
63	3	22	16	1120311
63	4	22	16	1120312
63	5	22	16	1120313
63	6	22	16	1120314
80	1,6	27	20	1120315
80	2	27	20	1120316
80	2,5	27	20	1120317
80	3	27	20	1120318
80	4	27	20	1120319
80	5	27	20	1120320
80	6	27	20	1120321
100	1,6	32	24	1120322
100	2	32	24	1120323
100	2,5	32	24	1120324
100	3	32	24	1120325
100	4	32	24	1120326
100	5	32	24	1120327
100	6	32	24	1120328
100	8	32	16	1120329
125	1,6	32	26	1120330
125	2	32	26	1120331
125	2,5	32	26	1120332
125	3	32	26	1120333
125	4	32	26	1120334
125	5	32	26	1120335
125	6	32	26	1120336
125	8	32	18	1120337
125	10	32	18	1120338
160	2,5	40	30	1120339
160	3	40	30	1120340
160	4	40	30	1120341
160	5	40	30	1120342
160	6	40	30	1120343
160	8	40	22	1120344
160	10	40	22	1120345
160	12	40	22	1120346

Schnittwertempfehlungen ab Seite 529
Cutting data recommendations starting page 529

auf 3 Seiten schneidend
cutting on three sides

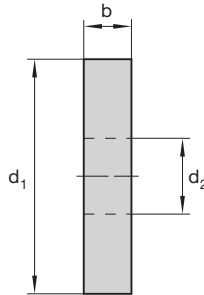

Katalog-Nr.	Cat.-No.	1266¹⁾
Typ	Type	N
Norm	Standard	DIN 1891 B
Drallwinkel	Helix angle	≈ 12° kreuzverzahnt staggered tooth
Werkstoff	Material	HSS-E EMo5Co5

d ₁ k 14	b k 11	d ₂ H 7	Nachstellbarkeit bis mm Adjustable up to mm	z	Ident No.
63	8	22	1	12	1092811
63	10	22	1	12	1092839
63	12	22	1	12	1092848
63	14	22	1,5	12	1092857
63	16	22	2	12	1092866
63	18	22	2	12	1092875
80	8	27	1	14	1092884
80	10	27	1	14	1092900
80	12	27	1	14	1092919
80	14	27	1,5	14	1092928
80	16	27	2	14	1092937
80	18	27	2	14	1092946
80	20	27	2,5	14	1092955
100	10	32	1	20	1092964
100	12	32	1	16	1092973
100	14	32	1,5	16	1092982
125	10	32	1	24	1093044
125	12	32	1	24	1093053
125	14	32	1,5	16	1093062
125	16	32	2	16	1093071
125	18	32	2	16	1093080
125	20	32	2,5	16	1093099
125	22	32	3	16	1093106
125	25	32	3,5	16	1093115
125	28	32	3,5	16	1093124

Nur noch lieferbar solange Vorrat
 Only supplyable until stock is depleted

Schnittwertempfehlungen ab Seite 529
 Cutting data recommendations starting page 529

für Eisele-Kreissägemaschinen
for Eisele sawing machines

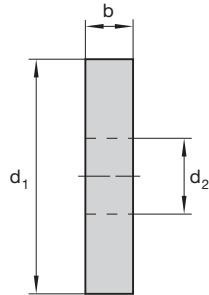

Katalog-Nr.	Cat.-No.	1291
Typ	Type	N / W ¹⁾
Norm	Standard	Werknorm Fette Standard
Zahnform nach DIN 1840	Tooth form DIN 1840	Bw / C
Werkstoff	Material	HSS DMo5

d ₁ js 15	b js 14	d ₂ H 7	Teilung Pitch	z	Zahnform Tooth form	Ident No.
225	2	32	3	220	Bw	1098110
225	2	32	4	180	Bw	1098129
225	2	32	6	120	C	1098138
225	2	32	8	90	C	1098147
225	2	40	3	220	Bw	1098156
225	2	40	4	180	Bw	1098165
225	2	40	6	120	C	1098174
225	2	40	8	90	C	1098183
250	2,5	40	4	200	Bw	1098227
250	2,5	40	6	128	C	1098236
250	2,5	40	8	100	C	1098245
275	2	40	3	280	Bw	1098254
275	2	40	4	220	Bw	1098263
275	2	40	6	140	C	1098272
275	2	40	8	110	C	1098281
275	2,5	40	3	280	Bw	1098290
275	2,5	40	4	220	Bw	1098307
275	2,5	40	6	140	C	1098316
275	2,5	40	8	110	C	1098325
300	2,5	40	4	220	Bw	1098334
300	2,5	40	6	160	C	1098343
300	2,5	40	8	120	C	1098352
315	2,5	40	4	220	Bw	1098361
315	2,5	40	6	160	C	1098370
315	2,5	40	8	120	C	1098389
350	3	40	4	280	Bw	1098398
350	3	40	5	200	Bw	1098405
350	3	40	9	120	C	1098414

¹⁾ Normalausführung für Aluminium-Bearbeitung Typ W
¹⁾ Standard design for machining of aluminium type W

Schnittwertempfehlungen ab Seite 529
Cutting data recommendations starting page 529

mit seitlichem Freischliff
Bohrung ohne Keilnut

with lateral clearance
hole without keyway

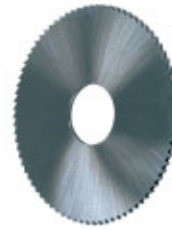
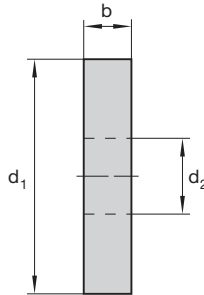

Katalog-Nr.	Cat.-No.	1281
Typ	Type	N
Norm	Standard	DIN 1837
Zahnform nach DIN 1840	Tooth form DIN 1840	Winkelzahn A Angular tooth A
Werkstoff	Material	HSS DMo5

d ₁ js 15	b js 11	d ₂ H 7	z	Ident No.
20	0,2	5	80	1093614
20	0,25	5	64	1093623
20	0,3	5	64	1093632
20	0,4	5	64	1093641
20	0,5	5	48	1093650
20	0,6	5	48	1093669
20	0,8	5	48	1093678
20	1	5	48	1093687
20	1,2	5	40	1093696
20	1,6	5	40	1093703
20	2	5	32	1093712
20	2,5	5	32	1093721
20	3	5	32	1093730
20	4	5	24	1093749
20	5	5	24	1093758
20	6	5	24	1093767
25	0,2	8	80	1093776
25	0,25	8	80	1093785
25	0,3	8	80	1093794
25	0,4	8	64	1093801
25	0,5	8	64	1093810
25	0,6	8	64	1093829
25	0,8	8	48	1093838
25	1	8	48	1093847
25	1,2	8	48	1093856
25	1,6	8	40	1093865
25	2	8	40	1093874
25	2,5	8	40	1093883
25	3	8	32	1093892
25	4	8	32	1093909
32	0,2	8	100	1095239
32	0,25	8	100	1095248
32	0,3	8	80	1095257
32	0,4	8	80	1095266
32	0,5	8	80	1095275
32	0,6	8	64	1095284
32	0,8	8	64	1095293
32	1	8	64	1095300

Schnittwertempfehlungen ab Seite 529
Cutting data recommendations starting page 529

mit seitlichem Freischliff
Bohrung ohne Keilnut

with lateral clearance
hole without keyway

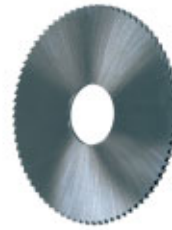
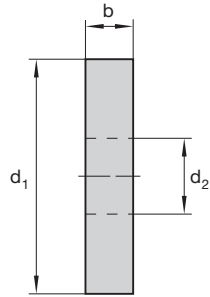

Katalog-Nr.	Cat.-No.	1281
Typ	Type	N
Norm	Standard	DIN 1837
Zahnform nach DIN 1840	Tooth form DIN 1840	Winkelzahn A Angular tooth A
Werkstoff	Material	HSS DMo5

d ₁ js 15	b js 11	d ₂ H 7	z	Ident No.
32	1,2	8	48	1095319
32	1,6	8	48	1095328
32	2	8	48	1095337
32	2,5	8	40	1095346
32	3	8	40	1095355
32	4	8	40	1095364
32	5	8	32	1095373
32	6	8	32	1095382
40	0,2	10	128	1094098
40	0,25	10	100	1094105
40	0,3	10	100	1094114
40	0,4	10	100	1094123
40	0,5	10	80	1094132
40	0,6	10	80	1094141
40	0,8	10	80	1094150
40	1	10	64	1094169
40	1,2	10	64	1094178
40	1,6	10	64	1094187
40	2	10	48	1094196
40	2,5	10	48	1094203
40	3	10	48	1094212
40	4	10	40	1094221
40	6	10	40	1094249
50	0,3	13	128	1094276
50	0,4	13	100	1094285
50	0,5	13	100	1094294
50	0,6	13	100	1094301
50	0,8	13	80	1094310
50	1	13	80	1094329
50	1,2	13	80	1094338
50	1,6	13	64	1094347
50	2	13	64	1094356
50	3	13	48	1094374
50	4	13	48	1094383
50	5	13	48	1094392
50	6	13	40	1094409
63	0,25	16	160	1094418
63	0,3	16	128	1094427

Schnittwertempfehlungen ab Seite 529
Cutting data recommendations starting page 529



mit seitlichem Freischliff
Bohrung ohne Keilnut

with lateral clearance
hole without keyway

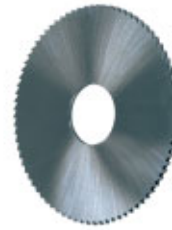
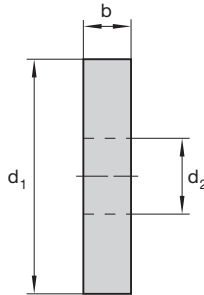

Katalog-Nr.	Cat.-No.	1281
Typ	Type	N
Norm	Standard	DIN 1837
Zahnform nach DIN 1840	Tooth form DIN 1840	Winkelzahn A Angular tooth A
Werkstoff	Material	HSS DMo5

d ₁ js 15	b js 11	d ₂ H 7	z ⚙	Ident No.
63	0,4	16	128	1094436
63	0,5	16	128	1094445
63	0,6	16	100	1094454
63	0,8	16	100	1094463
63	1	16	100	1094472
63	1,2	16	80	1094481
63	1,6	16	80	1094490
63	2	16	80	1094506
63	2,5	16	64	1094515
63	3	16	64	1094524
63	4	16	64	1094533
63	5	16	48	1094542
63	6	16	48	1094551
80	0,4	22	160	1094579
80	0,5	22	128	1094588
80	0,6	22	128	1094597
80	0,8	22	128	1094604
80	1	22	100	1094613
80	1,2	22	100	1094622
80	1,6	22	100	1094631
80	2	22	80	1094640
80	2,5	22	80	1094659
80	3	22	80	1094668
80	4	22	64	1094677
80	5	22	64	1094686
80	6	22	64	1094695
100	0,5	22	160	1094702
100	0,6	22	160	1094711
100	0,8	22	128	1094720
100	1	22	128	1094739
100	1,2	22	128	1094748
100	1,6	22	100	1094757
100	2	22	100	1094766
100	2,5	22	100	1094775
100	3	22	80	1094784
100	4	22	80	1094793
100	5	22	80	1094800
100	6	22	64	1094819

Schnittwertempfehlungen ab Seite 529
Cutting data recommendations starting page 529

mit seitlichem Freischliff
Bohrung ohne Keilnut

with lateral clearance
hole without keyway

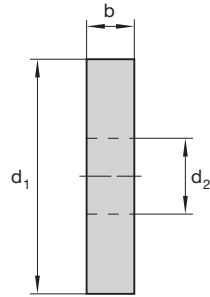

Katalog-Nr.	Cat.-No.	1281
Typ	Type	N
Norm	Standard	DIN 1837
Zahnform nach DIN 1840	Tooth form DIN 1840	Winkelzahn A Angular tooth A
Werkstoff	Material	HSS DMo5

d ₁ js 15	b js 11	d ₂ H 7	z ⚙	Ident No.
125	0,6	22	160	1094828
125	0,8	22	160	1094837
125	1	22	160	1094846
125	1,2	22	128	1094855
125	1,6	22	128	1094864
125	2	22	128	1094873
125	2,5	22	100	1094882
125	3	22	100	1094891
125	4	22	100	1094908
125	5	22	80	1094917
125	6	22	80	1094926
160	1	32	160	1094935
160	1,2	32	160	1094944
160	1,6	32	160	1094953
160	2	32	128	1094962
160	2,5	32	128	1094971
160	3	32	128	1094980
160	4	32	100	1094999
200	1	32	200	1095024
200	1,2	32	200	1095033
200	1,6	32	160	1095042
200	2	32	160	1095051
200	2,5	32	160	1095060
200	3	32	128	1095079
200	4	32	128	1095088
200	5	32	128	1095097
250	1,6	32	200	1095113
250	2	32	200	1095122
250	2,5	32	160	1095131

Schnittwertempfehlungen ab Seite 529
Cutting data recommendations starting page 529

mit seitlichem Freischliff
Bohrung ohne Keilnut

with lateral clearance
hole without keyway

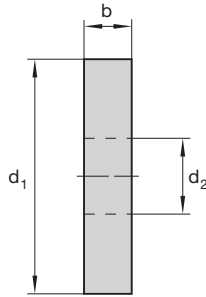

Katalog-Nr.		Cat.-No.		1282	1283
Typ		Type		N	
Norm		Standard		DIN 1838	
Zahnform nach DIN 1840		Tooth form DIN 1840		Bogenzahn B Hook tooth B	Bogenzahn C Hook tooth C
Werkstoff		Material		HSS DMo5	
d ₁ js 15	b js 11	d ₂ H 7	z ⚙	Ident No.	Ident No.
50	0,5	13	48	1095710	-
50	0,6	13	48	1095729	-
50	0,8	13	40	1095738	-
50	1	13	40	1095747	1096915
50	1,2	13	40	1095756	1096924
50	1,6	13	32	1095765	1096933
50	2	13	32	1095774	1096942
50	2,5	13	32	1095783	1096951
50	3	13	24	1095792	-
50	4	13	24	1095809	-
50	5	13	24	1095818	-
50	6	13	20	1095827	-
63	0,5	16	64	1095836	-
63	0,6	16	48	1095845	-
63	0,8	16	48	1095854	-
63	1	16	48	1095863	1097004
63	1,2	16	40	1095872	1097013
63	1,6	16	40	1095881	1097022
63	2	16	40	1095890	1097031
63	2,5	16	32	1095907	-
63	3	16	32	1095916	1097059
63	4	16	32	1095925	1097068
63	5	16	24	1095934	-
63	6	16	24	-	1097086
80	0,5	22	64	1095952	-
80	0,6	22	64	1095961	-
80	0,8	22	64	1095970	-
80	1	22	48	1095989	1097095
80	1,2	22	48	1095998	1097102
80	1,6	22	48	1096005	1097111
80	2	22	40	1096014	1097120
80	2,5	22	40	1096023	1097139
80	3	22	40	1096032	1097148
80	4	22	32	1096041	1097157
80	5	22	32	1096050	1097166
80	6	22	32	1096069	1097175
100	0,6	22	80	1096087	-
100	0,8	22	64	1096096	-
100	1	22	64	1096103	1097184
100	1,2	22	64	1096112	1097193

Schnittwertempfehlungen ab Seite 529
Cutting data recommendations starting page 529

mit seitlichem Freischliff
Bohrung ohne Keilnut

with lateral clearance
hole without keyway

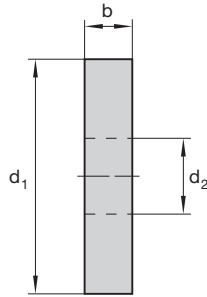

Katalog-Nr.	Cat.-No.	1282		1283	
Typ	Type	N			
Norm	Standard	DIN 1838			
Zahnform nach DIN 1840	Tooth form DIN 1840	Bogenzahn B Hook tooth B		Bogenzahn C Hook tooth C	
Werkstoff	Material	HSS DMo5			
d ₁ js 15	b js 11	d ₂ H 7	z	Ident No.	Ident No.
100	1,6	22	48	1096121	1097200
100	2	22	48	1096130	1097219
100	2,5	22	48	1096149	1097228
100	3	22	40	1096158	1097237
100	4	22	40	1096167	1097246
100	5	22	40	1096176	1097255
125	1	22	80	1096210	1097273
125	1,2	22	64	1096229	1097282
125	1,6	22	64	1096238	1097291
125	2	22	64	1096247	1097308
125	2,5	22	48	-	1097317
125	3	22	48	1096265	1097326
125	4	22	48	1096274	1097335
125	5	22	40	-	1097344
125	6	22	40	-	1097353
160	1	32	80	-	1097362
160	1,6	32	80	1096327	1097380
160	2	32	64	1096336	1097399
160	2,5	32	64	1096345	1097406
160	3	32	64	1096354	1097415
160	4	32	48	-	1097424
160	5	32	48	1096372	1097433
160	6	32	48	1096381	1097442
200	1	32	100	1096390	-
200	1,2	32	100	1096407	1097460
200	1,6	32	80	1096416	1097479
200	2	32	80	1096425	1097488
200	2,5	32	80	1096434	-
200	3	32	64	1096443	1097503
200	4	32	64	-	1097512
200	5	32	64	1096461	1097521
200	6	32	48	1096470	1097530
250	2	32	100	-	1097558
250	3	32	80	-	1097576

Schnittwertempfehlungen ab Seite 529
Cutting data recommendations starting page 529

**Vollhartmetall
mit seitlichem Freischliff
Bohrung ohne Keilnut**

**Solid Carbide
with lateral clearance
hole without keyway**

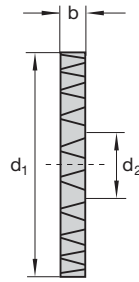

Katalog-Nr.	Cat.-No.	1288	1289
Besonderheiten	Special features	Winkelzahn Angular tooth	Bogenzahn Rounded tooth
Typ	Type	N	
Norm	Standard	DIN 1837	DIN 1838
Zahnform	Tooth form	fein fine	grob coarse
Schneidstoffsorten ¹⁾	Cutting Materials ¹⁾	LW615	

d ₁ js 15	d ₂ H 7	b ₁ js 11	z	Ident No.	z	Ident No.	d ₁ js 15	d ₂ H 7	b js 11	z	Ident No.	z	Ident No.		
				1288		1289						1288		1289	
20	5	0,2	40	1098425	20	1098672	40	10	1	72	1098509	36	1098756		
20	5	0,25	40	1098427	20	1098674	40	10	1,2	72	1098511	36	1098758		
20	5	0,3	40	1098429	20	1098676	40	10	1,6	72	1098513	36	1098760		
20	5	0,4	40	1098431	20	1098678	40	10	2	72	1098517	36	1098764		
20	5	0,5	40	1098433	20	1098680	40	10	2,5	72	1098519	36	1098766		
20	5	0,6	40	1098435	20	1098682	40	10	3	72	1098521	36	1098768		
20	5	0,8	40	1098437	20	1098684	50	13	0,25	80	1098523	40	1098770		
20	5	1	40	1098439	20	1098686	50	13	0,3	80	1098525	40	1098772		
20	5	1,2	40	1098441	20	1098688	50	13	0,4	80	1098527	40	1098774		
20	5	1,6	40	1098443	20	1098690	50	13	0,5	80	1098529	40	1098776		
20	5	2	40	1098447	20	1098694	50	13	0,6	80	1098531	40	1098778		
25	8	0,2	48	1098449	24	1098696	50	13	0,8	80	1098533	40	1098780		
25	8	0,25	48	1098451	24	1098698	50	13	1	80	1098535	40	1098782		
25	8	0,3	48	1098453	24	1098700	50	13	1,2	80	1098537	40	1098784		
25	8	0,4	48	1098455	24	1098702	50	13	1,6	80	1098539	40	1098786		
25	8	0,5	48	1098457	24	1098704	50	13	2	40	1098543	40	1098790		
25	8	0,6	48	1098459	24	1098706	50	13	2,5	40	1098545	40	1098792		
25	8	0,8	48	1098461	24	1098708	50	13	3	40	1098547	40	1098794		
25	8	1	48	1098463	24	1098710	63	16	0,25	40	1098549	40	1098796		
25	8	1,2	48	1098465	24	1098712	63	16	0,3	40	1098551	40	1098798		
25	8	1,6	48	1098467	24	1098714	63	16	0,4	40	1098553	40	1098800		
25	8	2	48	1098471	24	1098718	63	16	0,5	40	1098555	40	1098802		
32	8	0,25	60	1098473	30	1098720	63	16	0,6	40	1098557	40	1098804		
32	8	0,3	60	1098475	30	1098722	63	16	0,8	40	1098559	40	1098806		
32	8	0,4	60	1098477	30	1098724	63	16	1	40	1098561	40	1098808		
32	8	0,5	60	1098479	30	1098726	63	16	1,2	40	1098563	40	1098810		
32	8	0,6	60	1098481	30	1098728	63	16	1,6	40	1098565	40	1098812		
32	8	0,8	60	1098483	30	1098730	63	16	2	40	1098569	40	1098816		
32	8	1	60	1098485	30	1098732	63	16	2,5	40	1098571	40	1098818		
32	8	1,2	60	1098487	30	1098734	63	16	3	40	1098573	40	1098820		
32	8	1,6	60	1098489	30	1098736	80	22	0,3	100	1098575	48	1098822		
32	8	2	60	1098493	30	1098740	80	22	0,4	100	1098577	48	1098824		
32	8	2,5	60	1098495	30	1098742	80	22	0,5	100	1098579	48	1098826		
40	10	0,25	72	1098497	36	1098744	80	22	0,6	100	1098581	48	1098828		
40	10	0,3	72	1098499	36	1098746	80	22	0,8	100	1098583	48	1098830		
40	10	0,4	72	1098501	36	1098748	80	22	1	100	1098585	48	1098832		
40	10	0,5	72	1098503	36	1098750	80	22	1,2	100	1098587	48	1098834		
40	10	0,6	72	1098505	36	1098752	80	22	1,6	100	1098589	48	1098836		
40	10	0,8	72	1098507	36	1098754	80	22	2	100	1098593	48	1098840		

¹⁾ Sortenbeschreibung siehe Seite 22
¹⁾ Description of grades see page 22

Schnittwertempfehlungen ab Seite 529
Cutting data recommendations starting page 529

**Vollhartmetall
mit seitlichem Freischliff
Bohrung ohne Keilnut**

**Solid Carbide
with lateral clearance
hole without keyway**

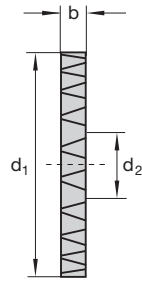

Katalog-Nr.	Cat.-No.	1288	1289
Besonderheiten	Special features	Winkelzahn Angular tooth	Bogenzahn Rounded tooth
Typ	Type	N	
Norm	Standard	DIN 1837	DIN 1838
Zahnform	Tooth form	fein fine	grob coarse
Schneidstoffsorten ¹⁾	Cutting Materials ¹⁾	LW615	

d ₁ js 15	d ₂ H 7	b js 11	z	Ident No.	z	Ident No.
80	22	2,5	100	1098595	48	1098842
80	22	3	100	1098597	48	1098844
100	22	0,4	120	1098599	60	1098846
100	22	0,5	120	1098601	60	1098848
100	22	0,6	120	1098603	60	1098850
100	22	0,8	120	1098605	60	1098852
100	22	1	120	1098607	60	1098854
100	22	1,2	120	1098609	60	1098856
100	22	1,6	120	1098611	60	1098858
100	22	2	120	1098615	60	1098862
100	22	2,5	120	1098617	60	1098864
100	22	3	120	1098619	60	1098866
125	22	0,6	140	1098621	70	1098868
125	22	0,8	140	1098623	70	1098870
125	22	1	140	1098625	70	1098872
125	22	1,2	140	1098627	70	1098874
125	22	1,6	140	1098629	70	1098876
125	22	2	140	1098633	70	1098880
125	22	2,5	140	1098635	70	1098882
125	22	3	140	1098637	70	1098884
160	32	1	160	1098655	80	1098902
160	32	1,2	160	1098657	80	1098905
160	32	1,6	160	1098659	80	1098906
160	32	1,8	160	1098661	80	1098908
160	32	2	160	1098663	80	1098910
160	32	2,5	160	1098665	80	1098912
160	32	3	160	1098667	80	1098914

¹⁾ Sortenbeschreibung siehe Seite 22
¹⁾ Description of grades see page 22

Schnittwertempfehlungen ab Seite 529
Cutting data recommendations starting page 529

Bohrung ohne Keilnut
Hole without keyway

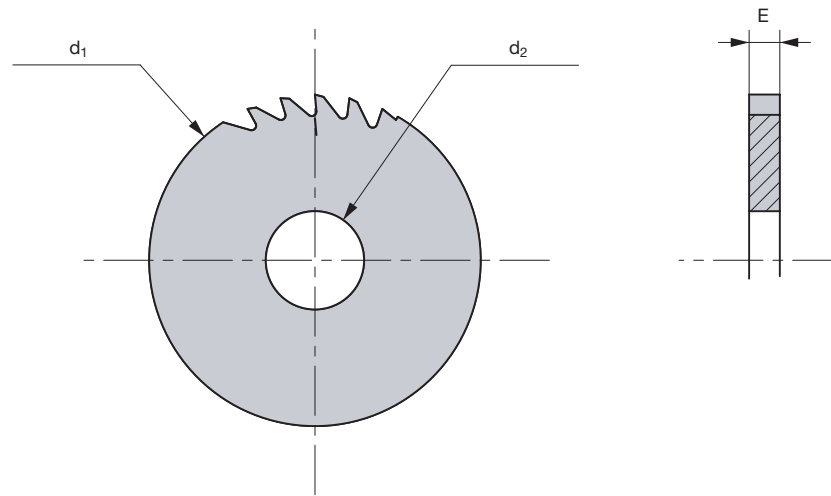

Katalog-Nr.	Cat.-No.	500
Typ	Type	N
Norm	Standard	DIN 1830
Zahnform DIN 1840	Toothform DIN 1840	Winkelzahn A Angular tooth A
Werkstoff	material	K 10

Kreissägeblatt geradeverzahnt Slitting saws straight tooth

d ₁	d ₂ h ₇	E mm ±0,01	Alu Alu Z	Stahl Steel Z	NE Z	Ident No.
15	5	0,5-6	8- 20	12- 50	6- 20	500015
20	5	0,5-6	10- 30	16- 80	8- 24	500020
25	8	0,5-6	12- 40	20-100	10- 30	500025
30	8	0,5-6	16- 50	24-100	12- 40	500030
32	8	0,5-6	20- 60	30-100	16- 44	500032
40	8/10	0,5-6	20- 60	40-120	20- 50	500040
45	10	0,5-6	24- 60	40-120	20- 50	500045
50	13	0,5-6	24- 70	44-144	24- 60	500050
60	16	0,5-6	30- 80	50-144	30- 80	500060
63	13/16	0,5-6	30- 80	60-144	30- 80	500063
70	16	0,5-6	36- 90	70-160	32- 80	500070
80	22	0,5-6	40-100	80-160	40- 90	500080
90	22	0,5-6	44-120	90-200	44-100	500090
100	22	0,5-6	50-120	100-200	50-100	500100
125	22	1 -6	60-144	120-200	60-120	500125
130	22	1 -6	70-144	120-200	70-120	500130
150	32	1 -6	80-160	144-220	80-144	500150
160	32	1 -6	80-160	144-220	80-144	500160

**Bohrung ohne Keilnut
Rechtsneigung**

**Hole without keyway
Right-hand inclined**

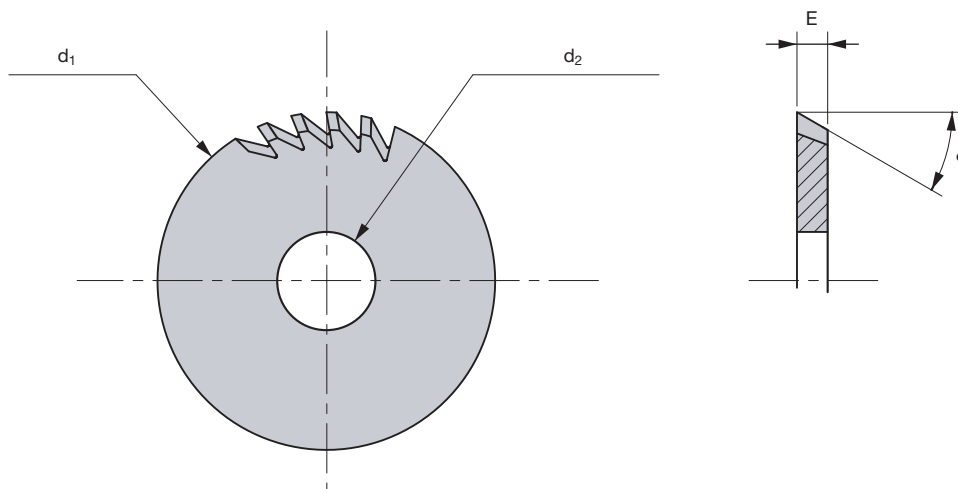

Katalog-Nr.	Cat.-No.	514 R
Typ	Type	N
Norm	Standard	Werksnorm
Werkstoff	material	K 10

Kreissägeblatt schrägverzahnt rechts Slitting saws inclined r.h. tooth							Ident No.
d ₁	d ₂ h ₇	E mm ±0,01	Alpha	Alu Alu Z	Stahl Steel Z	NE Z	
15	5	0,5- 6	15°-75°	8- 20	12- 50	6- 20	514015R
20	5	0,5- 6	15°-75°	10- 30	16- 80	8- 24	514020R
25	8	0,5- 6	15°-75°	12- 40	20-100	10- 30	514025R
30	8	0,5- 6	15°-75°	16- 50	24-100	12- 40	514030R
32	8	0,5- 6	15°-75°	20- 60	30-100	16- 44	514032R
40	8/10	0,5- 6	15°-75°	20- 60	40-120	20- 50	514040R
45	10	0,5- 6	15°-75°	24- 60	40-120	20- 50	514045R
50	13	0,5- 6	15°-75°	24- 70	44-144	24- 60	514050R
60	16	0,5- 6	15°-75°	30- 80	50-144	30- 80	514060R
63	13/16	0,5- 6	15°-75°	30- 80	60-144	30- 80	514063R
70	16	0,5- 6	15°-75°	36- 90	70-160	32- 80	514070R
80	22	0,5- 6	15°-75°	40-100	80-160	40- 90	514080R
90	22	0,5- 6	15°-75°	44-120	90-200	44-100	514090R
100	22	0,5- 6	15°-75°	50-120	100-200	50-100	514100R
125	22	1 - 6	15°-75°	60-144	120-200	60-120	514125R
130	22	1 - 6	15°-75°	70-144	120-200	70-120	514130R
150	32	1 - 6	15°-75°	80-160	144-220	80-144	514150R
160	32	1 - 6	15°-75°	80-160	144-220	80-144	514160R

**Bohrung ohne Keilnut
Linksneigung**

**Hole without keyway
Left-hand inclined**

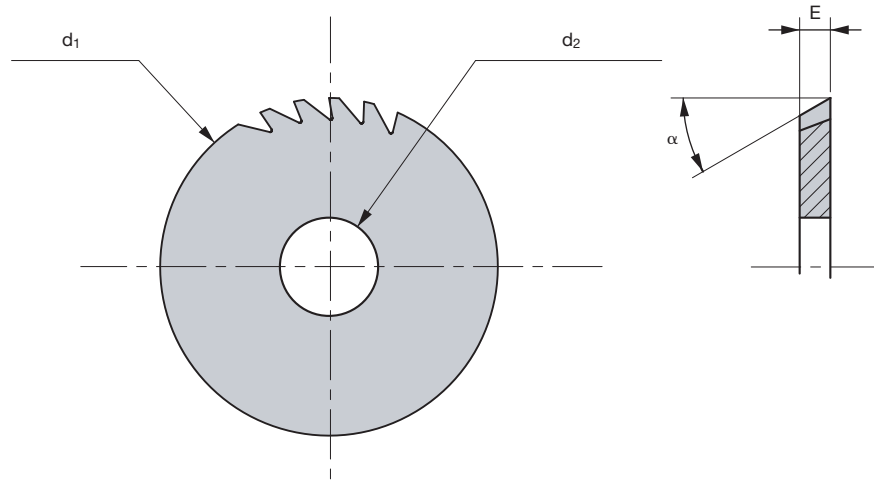

Katalog-Nr.	Cat.-No.	514 G
Typ	Type	N
Norm	Standard	Werksnorm
Werkstoff	material	K 10

Kreissägeblatt schrägverzahnt links Slitting saws inclined l.h. tooth							Ident No.
d ₁	d ₂ h ₇	E mm ±0,01	Alpha	Alu Alu Z	Stahl Steel Z	NE Z	
15	5	0,5-6	15°-75°	8 - 20	12 - 50	6 - 20	514015G
20	5	0,5-6	15°-75°	10 - 30	16 - 80	8 - 24	514020G
25	8	0,5-6	15°-75°	12 - 40	20-100	10 - 30	514025G
30	8	0,5-6	15°-75°	16 - 50	24-100	12 - 40	514030G
32	8	0,5-6	15°-75°	20 - 60	30-100	16 - 44	514032G
40	8/10	0,5-6	15°-75°	20 - 60	40-120	20 - 50	514040G
45	10	0,5-6	15°-75°	24 - 60	40-120	20 - 50	514045G
50	13	0,5-6	15°-75°	24 - 70	44-144	24 - 60	514050G
60	16	0,5-6	15°-75°	30 - 80	50-144	30 - 80	514060G
63	13/16	0,5-6	15°-75°	30 - 80	60-144	30 - 80	514063G
70	16	0,5-6	15°-75°	36 - 90	70-160	32 - 80	514070G
80	22	0,5-6	15°-75°	40-100	80-160	40 - 90	514080G
90	22	0,5-6	15°-75°	44-120	90-200	44-100	514090G
100	22	0,5-6	15°-75°	50-120	100-200	50-100	514100G
125	22	1 - 6	15°-75°	60-144	120-200	60-120	514125G
130	22	1 - 6	15°-75°	70-144	120-200	70-120	514130G
150	32	1 - 6	15°-75°	80-160	144-220	80-144	514150G
160	32	1 - 6	15°-75°	80-160	144-220	80-144	514160G

Bohrung ohne Keilnut
gleichschenkelig

Hole without keyway
isosceles

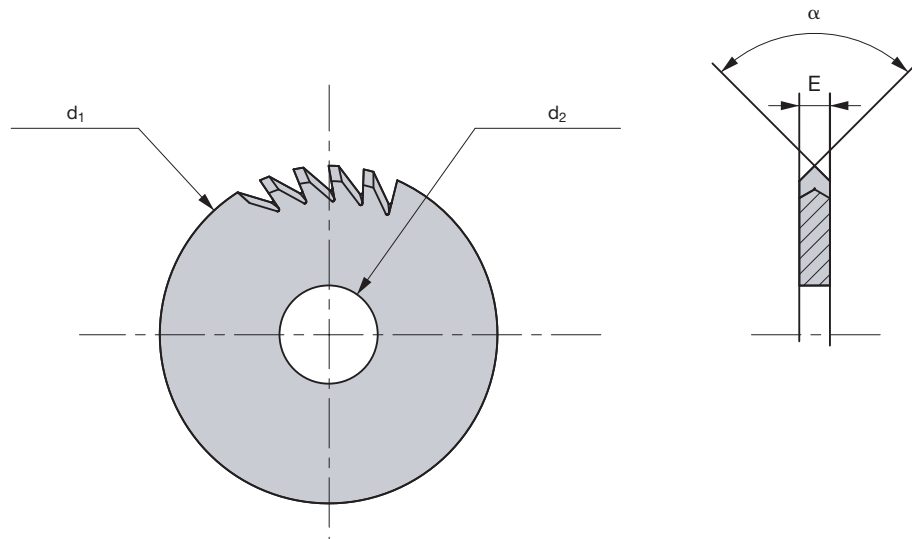

Katalog-Nr.	Cat.-No.	523
Typ	Type	N
Norm	Standard	Werkstoffnorm
Werkstoff	material	K 10

Kreissägeblatt spitz Slitting saws isosceles							Ident No.
d ₁	d ₂ h ₇	E mm ±0,01	Alpha	Alu Alu z	Stahl Steel z	NE z	
15	5	0,5-6	30°-120°	8- 16	12- 24	6- 10	523015
20	5	0,5-6	30°-120°	10- 16	16- 40	8- 12	523020
25	8	0,5-6	30°-120°	12- 20	20- 50	10- 20	523025
30	8	0,5-6	30°-120°	16- 24	24- 50	12- 30	523030
32	8	0,5-6	30°-120°	20- 30	30- 50	16- 30	523032
40	8/10	0,5-6	30°-120°	20- 30	40- 60	20- 36	523040
45	10	0,5-6	30°-120°	24- 30	40- 60	20- 36	523045
50	13	0,5-6	30°-120°	24- 30	44- 70	24- 40	523050
60	16	0,5-6	30°-120°	30- 50	50- 70	30- 60	523060
63	13/16	0,5-6	30°-120°	30- 50	60- 80	30- 60	523063
70	16	0,5-6	30°-120°	36- 60	70- 90	32- 60	523070
80	22	0,5-6	30°-120°	40- 70	80-100	40- 70	523080
90	22	0,5-6	30°-120°	44- 80	90-120	44- 70	523090
100	22	0,5-6	30°-120°	50- 80	100-144	50- 80	523100
125	22	1 -6	30°-120°	60-100	120-160	60- 90	523125
130	22	1 -6	30°-120°	70-100	120-160	70-100	523130
150	32	1 -6	30°-120°	80-120	144-180	80-120	523150
160	32	1 -6	30°-120°	80-120	144-180	80<-120	523160

Werkstoff	Material	R _m /UTS (N/mm ²)	Scheiben-/Nutenfräser Side Milling Cutters Slotting Cutters		Metallkreissägen Metal Slitting Saws v _f (mm/min)			
			v _c m/min	f _z mm	v _c m/min	fein fine	mittel medium	grob coarse
Unlegierter Baustahl	Plain carbon steel	-700	35	0,1	50	80-160	63-250	40-63
Automatenstahl	Free cutting steel	-700	35	0,1	50	80-160	63-250	40-63
Baustahl	Structural alloy steel	500-950	25	0,08	40	63-80	50-160	25-35
Vergütungsstahl, mittelfest	Heat-treatable steel, medium strength	500-950	25	0,08	40	63-100	40-80	32-63
Stahlguss	Cast steel	-950	25	0,06	35	63-100	40-80	32-63
Einsatzstahl	Case hardening steel	-950	30	0,06	40	80-160	63-200	40-63
Rost- und säurebeständiger Stahl, ferritisch, martensitisch	Stainless steel, ferritic, martensitic	500-950	20	0,06	25	40-63	32-45	16-25
Vergütungsstahl, hochfest	Heat-treatable steel, high strength	950-1400	20	0,06	25	40-63	25-40	10-25
Nitrierstahl, vergütet	Nitriding steel	950-1400	20	0,06	25	40-80	25-63	20-50
Werkzeugstahl	Tool steel	950-1400	20	0,06	20	20-40	12-25	8-16
Rost- und säurebeständiger Stahl, austenitisch	Stainless steel, austenitic	500-950	25	0,08	20	30-63	50-100	20-32
Martensitaushärtbarer Stahl	Maraging steel	500-950	25	0,08	20	30-63	50-100	20-32
Grauguss	Grey cast iron	100-400 (120-260 HB)	30	0,08	40	80-160	63-200	40-63
Legierter Grauguss	Alloyed grey cast iron	150-250 (160-230 HB)	25	0,06	30	63-80	50-160	25-35
Sphäroguss	Nodular cast iron	400-800 (120-310 HB)	35	0,06	30	63-80	50-160	25-35
Temperguss	Malleable cast iron	350-700 (150-280 HB)	40	0,08	35	63-100	40-80	32-63
Rein-Metalle, weich	Pure metals, soft	-500	140	0,1	150	100-800	320-800	80-400
Aluminium-Legierungen, langspanend	Aluminium alloys, long chipping	-550	350	0,1	400	250-2500	320-1600	250-1200
Aluminium-Legierungen, kurzspanend	Aluminium alloys, short chipping	-400	80	0,1	250	150-1500	150-1000	100-600
Kupfer-Legierungen, langspanend	Copper alloys, long chipping	300-700	50	0,12	100	100-800	320-800	80-400
Kupfer-Legierungen, kurzspanend	Copper alloys, short chipping	-500	50	0,12	100	100-1000	500-1000	80-500
Magnesium-Legierungen	Magnesium alloys	160-300	350	0,1	300	250-2000	320-1500	250-1000
Thermoplaste	Thermoplastics	40-70	100	0,1	100	100-800	320-800	80-400
Duroplaste	Duroplastics	20-40	60	0,08	80	100-600	300-600	200-800
Titan-Legierungen, mittelfest	Titanium alloys, medium strength	-950	20	0,07	25	40-63	25-40	10-25
Titan-Legierungen, hochfest	Titanium alloys, high strength	900-1400	12	0,06	15	20-40	12-25	8-16
Nickelbasis-Legierungen, mittelfest	Nickel based alloys, medium strength	-950	20	0,08	25	40-63	25-40	10-25
Hochwärmefeste Nickel-Basis-Legierungen	Heat resistant nickel based alloys, high strength	900-1400	12	0,05	15	20-40	12-25	8-16
Hartguss	Chilled cast iron	300-600	12	0,04	15	20-40	12-25	8-16

Drehzahl Speed $n = \frac{v_c \cdot 1000}{\pi \cdot d_1} \cdot f_1$ v_c Tab. Seite 529 Page 529	Vorschubgeschwindigkeit Feed rate $v_f = f_z \cdot z \cdot n \cdot f_2$ f_z Tab. Seite 529 Page 529	a_e = Schnittbreite in mm Width of cut in mm a_p = Schnitttiefe in mm Depth of cut in mm d_1 = Durchmesser in mm Cutter diameter in mm f_1 = Korrekturfaktor für v_c Correction factor v_c f_2 = Korrekturfaktor für v_f Correction factor v_f f_z = Vorschub pro Zahn in mm Feed per tooth in mm LF = Leistungsfaktor in $\text{cm}^3/\text{min}/\text{kW}$ Efficiency factor in $\text{cm}^3/\text{min}/\text{kW}$ n = Drehzahl in min^{-1} Speed in min^{-1} P_e = Spindelleistung in kW Drive power in kW Q = Spanvolumen in cm^3/min Chip volume in cm^3/min v_c = Schnittgeschwindigkeit in m/min Cutting speed in m/min v_f = Vorschubgeschwindigkeit in mm/min Feed rate in mm/min z = Anzahl der Schneiden No. of teeth
Spanvolumen Chip volume $Q = \frac{a_e \cdot a_p \cdot v_f}{1000}$	Spindelleistung Drive power $P_e \approx \frac{Q}{LF}$	

Schnittgeschwindigkeitskorrektur f_1

Cutting speed correction factor f_1

	unbeschichtet uncoated	TiN	TiCN	TiCN Plus	AL Plus
$f_1 =$	1	1,3	1,6	1,6	1,6

Vorschubkorrektur f_2

Feed rate correction factor f_2

	kreuzverzahnt staggered tooth	Metallkreissägen geradeverzahnt Metal Slitting Saws straight tooth
$f_2 =$	0,5	1



Formfräser HSS-E

Form Milling Cutters HSS-E

Auswahlübersicht Selection tables	534, 535, 536, 538
Typenbeschreibungen Type descriptions	540
Formfräser mit Schaft Form Milling Cutters with shank	545
Formfräser mit Bohrung Form Milling Cutters with bore	551
Formfräser für Verzahnung Form Milling Cutters for gears	565
Schnittwertempfehlungen Cutting data recommendations	580, 582

Auswahlübersicht Selection table

Formfräser mit Schaft Form Milling Cutters with shank

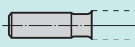
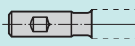
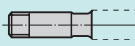
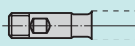
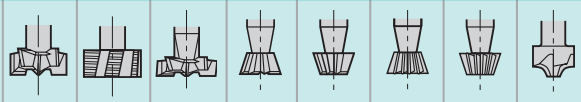
			Seite Page								
Zylinderschaft DIN 1835 A Straight shank DIN 1835 A				545	546	547			549	549	
Mit Mitnahmefläche DIN 1835 B Clamping flat DIN 1835 B				545	546				549	549	
Mit Anzugsgewinde DIN 1835 D With draw bar shank DIN 1835 D				545	546						
Mit Anzugsgewinde + Mitnahmefläche DIN 1835 B+D With draw bar shank + drive flat DIN 1835 B+D						547	548	548		550	
											
			Typ	N	NF	N	N		H		N
● sehr gut geeignet well suited ○ auch geeignet also suited			Schneidengeometrie Cutting geometrie	≈ 12° 118 kreuz- verzahnt staggered tooth	≈ 25°/ Rechtsdrall R.H. Helix ≈ 9° ¹⁾	≈ 8° kreuz- verzahnt staggered tooth	drallgenutet spiral fluted am Umfang und an der Stirnseite schneidend cutting on both side and face		geradegenutet straight fluted am Umfang schneidend cutting on periphery		≈ 5° Axialwinkel Axial angle
				Schaftfräser für T-Nuten T-slot Milling Cutters	Schlitzfräser für Nuten Woodruff Keyseat Cutters	Winkelfräser Angle Milling Cutters				Viertelrund Profilfräser Corner Rounding Cutter	
Werkstoff	Material	R_m/UTS (N/mm²)									
Unlegierter Baustahl	Plain carbon steel	- 700	●	●	●	●	●	●	○	○	●
Automatenstahl	Free cutting steel	- 700	●	●	●	●	●	●	○	○	●
Baustahl	Structural low alloy steel	500 - 950	●	●	●	●	●	●	○	○	●
Vergütungsstahl, mittelfest	Heat-treatable steel, medium strength	500 - 950	●	●	●	●	●	●	○	○	●
Stahlguß	Cast steel	- 950	●	●	●	●	●	●	○	○	●
Einsatzstahl	Case hardening steel	- 950	●	●	●	●	●	●	○	○	●
Rost- und säurebeständiger Stahl, ferritisch, martensitisch	Stainless steel, ferritic, martensitic	500 - 950	●	●	●	●	●	●	○	○	●
Vergütungsstahl, hochfest	Heat-treatable steel, high strength	950 - 1400	○	●	○	○	○	○	●	●	○
Nitrierstahl, vergütet	Nitriding steel	950 - 1400	○	●	○	○	○	○	●	●	○
Werkzeugstahl (bis 45 HRC)	Tool steel (to 45 HRC)	950 - 1400	○	●	○	○	○	○	●	●	○
Rost- und säurebeständiger Stahl, austenitisch	Stainless steel, austenitic	500 - 950									
Martensitaushärtbarer Stahl	Maraging steel										
Grauguß	Grey cast iron	100 - 400 (120 - 260 HB)	●	●	●	●	●	●	●	●	●
Legierter Grauguß	Alloyed grey cast iron	150 - 250 (160 - 230 HB)	●	●	●	●	●	●	●	●	●
Sphäroguß	Nodular cast iron	400 - 800 (120 - 310 HB)	●	●	●	●	●	●	○	○	●
Temperguß	Malleable cast iron	350 - 700 (150 - 280 HB)	●	●	●	●	●	●	○	○	●
Rein-Metalle, weich	Pure metals, soft	- 500	○	○	○	○	○	○			○
Aluminium-Legierungen, langspanend	Aluminium alloys, long chipping	- 550	○	○	○	○	○	○			○
Aluminium-Legierungen, kurzspanend	Aluminium alloys, short chipping	- 400	●	●	●	●	●	●	○	○	●
Kupfer-Legierungen, langspanend	Copper alloys, long chipping	300 - 700	○	○	○	○	○	○			○
Kupfer-Legierungen, kurzspanend	Copper alloys, short chipping	- 500	●	●	●	●	●	●	○	○	●
Magnesium-Legierungen	Magnesium alloys	150 - 300	●	●	●	●	●	●	○	○	●
Thermoplaste	Thermoplastics	40 - 70	○	○	○	○	○	○			○
Duroplaste	Duroplastics	20 - 40	●	●	●	●	●	●	●	●	●
Graphit	Graphite										
Titanlegierungen, mittelfest	Titanium alloys, medium strength	- 950	○	●	○	○	○	○	●	●	○
Titanlegierungen, hochfest	Titanium alloys, high strength	900 - 1400	○	○	○	○	○	○	●	●	○
Nickelbasislegierungen, mittelfest	Nickel based alloys, medium strength	- 950	○	○	○	○	○	○	●	●	○
Nickelbasislegierungen, hochwarmfest	Heat resistant nickel based alloys, high strength	900 - 1400	○	○	○	○	○	○	●	●	○
Hartguß	Chilled cast iron	300 - 600	○	○	○	○	○	○	●	●	○
gehärteter Stahl	hardened steel										

¹⁾ mit Eckenradius with corner radius

Auswahlübersicht Selection table





Formfräser mit Bohrung Form Milling Cutters with bore

				Seite Page					
				551	552	553	554	556	557
				H	NF	H	N		
<ul style="list-style-type: none"> ● sehr gut geeignet well suited ○ auch geeignet also suited 				Schneidengeometrie Cutting geometry					
				gerade verzahnt Fasenschliff straight tooth relieved land	Schrupp- Schlicht- verzahnung truncated type for roughing	gefräste Ausführung Fasenschliff milled relieved land	konvex convex radial hinterdreht radially backed off	konkav concave hinterdreht radially, axially backed off	konkav concave radial, achsial hinterdreht radially, axially backed off
				Aufsteck-Winkel-Fräser Shell Type Milling Cutters		Prismenfräser Double Angle Milling Cutters	Halbrund-Profilfräser Form-Relieved Cutters		Viertelrund Profilfräser Form-Relieved Corner Rounded Cutters
Werkstoff	Material	R _m /UTS (N/mm ²)							
Unlegierter Baustahl	Plain carbon steel	- 700	○	●	○	●	●	●	
Automatenstahl	Free cutting steel	- 700	○	●	○	●	●	●	
Baustahl	Structural low alloy steel	500 - 950	○	●	○	●	●	●	
Vergütungsstahl, mittelfest	Heat-treatable steel, medium strength	500 - 950	○	●	○	●	●	●	
Stahlguß	Cast steel	- 950	○	●	○	●	●	●	
Einsatzstahl	Case hardening steel	- 950	○	●	○	●	●	●	
Rost- und säurebeständiger Stahl, ferritisch, martensitisch	Stainless steel, ferritic, martensitic	500 - 950	○	●	○	●	●	●	
Vergütungsstahl, hochfest	Heat-treatable steel, high strength	950 - 1400	●	○	●	●	●	●	
Nitrierstahl, vergütet	Nitriding steel	950 - 1400	●	○	●	●	●	●	
Werkzeugstahl (bis 45 HRC)	Tool steel (to 45 HRC)	950 - 1400	●	○	●	●	●	●	
Rost- und säurebeständiger Stahl, austenitisch	Stainless steel, austenitic	500 - 950		●		○	○	○	
Martensitaushärtbarer Stahl	Maraging steel			●		○	○	○	
Grauguß	Grey cast iron	100 - 400 (120 - 260 HB)	●	●	●	●	●	●	
Legierter Grauguß	Alloyed grey cast iron	150 - 250 (160 - 230 HB)	●	●	●	●	●	●	
Sphäroguß	Nodular cast iron	400 - 800 (120 - 310 HB)	○	●	○	●	●	●	
Temperguß	Malleable cast iron	350 - 700 (150 - 280 HB)	○	●	○	●	●	●	
Rein-Metalle, weich	Pure metals, soft	- 500	○	○	○	○	○	○	
Aluminium-Legierungen, langspanend	Aluminium alloys, long chipping	- 550	○	○	○	○	○	○	
Aluminium-Legierungen, kurzspanend	Aluminium alloys, short chipping	- 400	○	●	○	●	●	●	
Kupfer-Legierungen, langspanend	Copper alloys, long chipping	300 - 700	○	○	○	○	○	○	
Kupfer-Legierungen, kurzspanend	Copper alloys, short chipping	- 500	○	●	○	●	●	●	
Magnesium-Legierungen	Magnesium alloys	150 - 300	○	●	○	●	●	●	
Thermoplaste	Thermoplastics	40 - 70	○	○	○	○	○	○	
Duroplaste	Duroplastics	20 - 40	○	●	○	●	●	●	
Graphit	Graphite								
Titanlegierungen, mittelfest	Titanium alloys, medium strength	- 950	○	●	○	●	●	●	
Titanlegierungen, hochfest	Titanium alloys, high strength	900 - 1400	●	●	●	○	○	○	
Nickelbasislegierungen, mittelfest	Nickel based alloys, medium strength	- 950	●	○	●	○	○	○	
Nickelbasislegierungen, hochwarmfest	Heat resistant nickel based alloys, high strength	900 - 1400	●	○	●	○	○	○	
Hartguß	Chilled cast iron	300 - 600	●	○	●	○	○	○	
gehärteter Stahl	hardened steel		●	○	●	○	○	○	

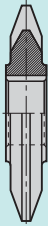
Auswahlübersicht Selection table

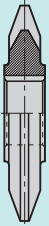

Formfräser für Verzahnung Form Milling Cutters for gears

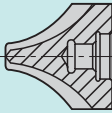



					
			Schneckenfräser Worm Cutters	Zahnstangenfräser/ Schneckenfräser Rack and Worm Cutters	
<ul style="list-style-type: none"> ● sehr gut geeignet well suited ○ auch geeignet also suited 			geradeverzahnt, gefräst straight tooth, milled	kreuzverzahnt, gefräst staggered tooth, milled	
			Seite Page	558	559
			Schneckenfräser Worm Cutter		
Werkstoff	Material	R _m /UTS (N/mm ²)			
Unlegierter Baustahl	Plain carbon steel	- 700	●	●	
Automatenstahl	Free cutting steel	- 700	●	●	
Baustahl	Structural low alloy steel	500 - 950	●	●	
Vergütungsstahl, mittelfest	Heat-treatable steel, medium strength	500 - 950	●	●	
Stahlguß	Cast steel	- 950	●	●	
Einsatzstahl	Case hardening steel	- 950	●	●	
Rost- und säurebeständiger Stahl, ferritisch, martensitisch	Stainless steel, ferritic, martensitic	500 - 950	●	●	
Vergütungsstahl, hochfest	Heat-treatable steel, high strength	950 - 1400	●	●	
Nitrierstahl, vergütet	Nitriding steel	950 - 1400	●	●	
Werkzeugstahl (bis 45 HRC)	Tool steel (to 45 HRC)	950 - 1400	●	●	
Rost- und säurebeständiger Stahl, austenitisch	Stainless steel, austenitic	500 - 950			
Martensitaushärtbarer Stahl	Maraging steel				
Grauguß	Grey cast iron	100 - 400 (120 - 260 HB)	●	●	
Legierter Grauguß	Alloyed grey cast iron	150 - 250 (160 - 230 HB)	●	●	
Sphäroguß	Nodular cast iron	400 - 800 (120 - 310 HB)	●	●	
Temperguß	Malleable cast iron	350 - 700 (150 - 280 HB)	●	●	
Rein-Metalle, weich	Pure metals, soft	- 500	○	○	
Aluminium-Legierungen, langspanend	Aluminium alloys, long chipping	- 550	○	○	
Aluminium-Legierungen, kurzspanend	Aluminium alloys, short chipping	- 400	●	●	
Kupfer-Legierungen, langspanend	Copper alloys, long chipping	300 - 700	○	○	
Kupfer-Legierungen, kurzspanend	Copper alloys, short chipping	- 500	●	●	
Magnesium-Legierungen	Magnesium alloys	150 - 300	●	●	
Thermoplaste	Thermoplastics	40 - 70	○	○	
Duroplaste	Duroplastics	20 - 40	●	●	
Graphit	Graphite				
Titanlegierungen, mittelfest	Titanium alloys, medium strength	- 950	●	●	
Titanlegierungen, hochfest	Titanium alloys, high strength	900 - 1400	○	○	
Nickelbasislegierungen, mittelfest	Nickel based alloys, medium strength	- 950	○	○	
Nickelbasislegierungen, hochwarmfest	Heat resistant nickel based alloys, high strength	900 - 1400	○	○	
Hartguß	Chilled cast iron	300 - 600	○	○	
gehärteter Stahl	hardened steel				

							
Schnecken-Vorfräser Worm Cutters for Roughing	Zahnstangenfräser/ Schneckenfräser Rack and Worm Cutters	Zahnstangenfräser/ Schneckenfräser Rack and Worm Cutters	Zahnformfräser Involute Gear Cutters	Zahnform-Vorfräser Circular Type Gear Roughing Cutters	Zahnform- Fingerfräser (Vorfräser) End Mill Gear Cutter Roughing Cutters	Zahnform- Fingerfräser (Fertigfräser) End Mill Gear Cutters Finish. Cutters	
kreuzverzahnt, gefräst staggered tooth, milled	geradeverzahnt, hinterdreht straight tooth, backed off	geradeverzahnt, hinterschliffen straight tooth, relief ground	hinterdreht backed off	hinterdreht, stufenförmig backed off, stepped-up type	gefräst und geschliffen milled and ground	hinterdreht mit Profilschliff backed off, Ground Profile lang	
560	561	562	563	567	565	566	
Schneckenfräser Worm Cutters			Zahnformfräser Involute Gear Cutters				
<input type="checkbox"/>	<input type="checkbox"/>	<input type="checkbox"/>	<input type="checkbox"/>	<input type="checkbox"/>	<input type="checkbox"/>	<input type="checkbox"/>	<input type="checkbox"/>
<input type="checkbox"/>	<input type="checkbox"/>	<input type="checkbox"/>	<input type="checkbox"/>	<input type="checkbox"/>	<input type="checkbox"/>	<input type="checkbox"/>	<input type="checkbox"/>
<input type="checkbox"/>	<input type="checkbox"/>	<input type="checkbox"/>	<input type="checkbox"/>	<input type="checkbox"/>	<input type="checkbox"/>	<input type="checkbox"/>	<input type="checkbox"/>
<input type="checkbox"/>	<input type="checkbox"/>	<input type="checkbox"/>	<input type="checkbox"/>	<input type="checkbox"/>	<input type="checkbox"/>	<input type="checkbox"/>	<input type="checkbox"/>
<input type="checkbox"/>	<input type="checkbox"/>	<input type="checkbox"/>	<input type="checkbox"/>	<input type="checkbox"/>	<input type="checkbox"/>	<input type="checkbox"/>	<input type="checkbox"/>
<input type="checkbox"/>	<input type="checkbox"/>	<input type="checkbox"/>	<input type="checkbox"/>	<input type="checkbox"/>	<input type="checkbox"/>	<input type="checkbox"/>	<input type="checkbox"/>
<input type="checkbox"/>	<input type="checkbox"/>	<input type="checkbox"/>	<input type="checkbox"/>	<input type="checkbox"/>	<input type="checkbox"/>	<input type="checkbox"/>	<input type="checkbox"/>
<input type="checkbox"/>	<input type="checkbox"/>	<input type="checkbox"/>	<input type="checkbox"/>	<input type="checkbox"/>	<input type="checkbox"/>	<input type="checkbox"/>	<input type="checkbox"/>
<input type="checkbox"/>	<input type="checkbox"/>	<input type="checkbox"/>	<input type="checkbox"/>	<input type="checkbox"/>	<input type="checkbox"/>	<input type="checkbox"/>	<input type="checkbox"/>
<input type="checkbox"/>	<input type="checkbox"/>	<input type="checkbox"/>	<input type="checkbox"/>	<input type="checkbox"/>	<input type="checkbox"/>	<input type="checkbox"/>	<input type="checkbox"/>
<input type="checkbox"/>	<input type="checkbox"/>	<input type="checkbox"/>	<input type="checkbox"/>	<input type="checkbox"/>	<input type="checkbox"/>	<input type="checkbox"/>	<input type="checkbox"/>
<input type="checkbox"/>	<input type="checkbox"/>	<input type="checkbox"/>	<input type="checkbox"/>	<input type="checkbox"/>	<input type="checkbox"/>	<input type="checkbox"/>	<input type="checkbox"/>
<input type="checkbox"/>	<input type="checkbox"/>	<input type="checkbox"/>	<input type="checkbox"/>	<input type="checkbox"/>	<input type="checkbox"/>	<input type="checkbox"/>	<input type="checkbox"/>
<input type="checkbox"/>	<input type="checkbox"/>	<input type="checkbox"/>	<input type="checkbox"/>	<input type="checkbox"/>	<input type="checkbox"/>	<input type="checkbox"/>	<input type="checkbox"/>
<input type="checkbox"/>	<input type="checkbox"/>	<input type="checkbox"/>	<input type="checkbox"/>	<input type="checkbox"/>	<input type="checkbox"/>	<input type="checkbox"/>	<input type="checkbox"/>
<input type="checkbox"/>	<input type="checkbox"/>	<input type="checkbox"/>	<input type="checkbox"/>	<input type="checkbox"/>	<input type="checkbox"/>	<input type="checkbox"/>	<input type="checkbox"/>
<input type="checkbox"/>	<input type="checkbox"/>	<input type="checkbox"/>	<input type="checkbox"/>	<input type="checkbox"/>	<input type="checkbox"/>	<input type="checkbox"/>	<input type="checkbox"/>
<input type="checkbox"/>	<input type="checkbox"/>	<input type="checkbox"/>	<input type="checkbox"/>	<input type="checkbox"/>	<input type="checkbox"/>	<input type="checkbox"/>	<input type="checkbox"/>
<input type="checkbox"/>	<input type="checkbox"/>	<input type="checkbox"/>	<input type="checkbox"/>	<input type="checkbox"/>	<input type="checkbox"/>	<input type="checkbox"/>	<input type="checkbox"/>
<input type="checkbox"/>	<input type="checkbox"/>	<input type="checkbox"/>	<input type="checkbox"/>	<input type="checkbox"/>	<input type="checkbox"/>	<input type="checkbox"/>	<input type="checkbox"/>
<input type="checkbox"/>	<input type="checkbox"/>	<input type="checkbox"/>	<input type="checkbox"/>	<input type="checkbox"/>	<input type="checkbox"/>	<input type="checkbox"/>	<input type="checkbox"/>
<input type="checkbox"/>	<input type="checkbox"/>	<input type="checkbox"/>	<input type="checkbox"/>	<input type="checkbox"/>	<input type="checkbox"/>	<input type="checkbox"/>	<input type="checkbox"/>
<input type="checkbox"/>	<input type="checkbox"/>	<input type="checkbox"/>	<input type="checkbox"/>	<input type="checkbox"/>	<input type="checkbox"/>	<input type="checkbox"/>	<input type="checkbox"/>
<input type="checkbox"/>	<input type="checkbox"/>	<input type="checkbox"/>	<input type="checkbox"/>	<input type="checkbox"/>	<input type="checkbox"/>	<input type="checkbox"/>	<input type="checkbox"/>
<input type="checkbox"/>	<input type="checkbox"/>	<input type="checkbox"/>	<input type="checkbox"/>	<input type="checkbox"/>	<input type="checkbox"/>	<input type="checkbox"/>	<input type="checkbox"/>
<input type="checkbox"/>	<input type="checkbox"/>	<input type="checkbox"/>	<input type="checkbox"/>	<input type="checkbox"/>	<input type="checkbox"/>	<input type="checkbox"/>	<input type="checkbox"/>
<input type="checkbox"/>	<input type="checkbox"/>	<input type="checkbox"/>	<input type="checkbox"/>	<input type="checkbox"/>	<input type="checkbox"/>	<input type="checkbox"/>	<input type="checkbox"/>
<input type="checkbox"/>	<input type="checkbox"/>	<input type="checkbox"/>	<input type="checkbox"/>	<input type="checkbox"/>	<input type="checkbox"/>	<input type="checkbox"/>	<input type="checkbox"/>
<input type="checkbox"/>	<input type="checkbox"/>	<input type="checkbox"/>	<input type="checkbox"/>	<input type="checkbox"/>	<input type="checkbox"/>	<input type="checkbox"/>	<input type="checkbox"/>
<input type="checkbox"/>	<input type="checkbox"/>	<input type="checkbox"/>	<input type="checkbox"/>	<input type="checkbox"/>	<input type="checkbox"/>	<input type="checkbox"/>	<input type="checkbox"/>
<input type="checkbox"/>	<input type="checkbox"/>	<input type="checkbox"/>	<input type="checkbox"/>	<input type="checkbox"/>	<input type="checkbox"/>	<input type="checkbox"/>	<input type="checkbox"/>
<input type="checkbox"/>	<input type="checkbox"/>	<input type="checkbox"/>	<input type="checkbox"/>	<input type="checkbox"/>	<input type="checkbox"/>	<input type="checkbox"/>	<input type="checkbox"/>
<input type="checkbox"/>	<input type="checkbox"/>	<input type="checkbox"/>	<input type="checkbox"/>	<input type="checkbox"/>	<input type="checkbox"/>	<input type="checkbox"/>	<input type="checkbox"/>
<input type="checkbox"/>	<input type="checkbox"/>	<input type="checkbox"/>	<input type="checkbox"/>	<input type="checkbox"/>	<input type="checkbox"/>	<input type="checkbox"/>	<input type="checkbox"/>
<input type="checkbox"/>	<input type="checkbox"/>	<input type="checkbox"/>	<input type="checkbox"/>	<input type="checkbox"/>	<input type="checkbox"/>	<input type="checkbox"/>	<input type="checkbox"/>
<input type="checkbox"/>	<input type="checkbox"/>	<input type="checkbox"/>	<input type="checkbox"/>	<input type="checkbox"/>	<input type="checkbox"/>	<input type="checkbox"/>	<input type="checkbox"/>
<input type="checkbox"/>	<input type="checkbox"/>	<input type="checkbox"/>	<input type="checkbox"/>	<input type="checkbox"/>	<input type="checkbox"/>	<input type="checkbox"/>	<input type="checkbox"/>
<input type="checkbox"/>	<input type="checkbox"/>	<input type="checkbox"/>	<input type="checkbox"/>	<input type="checkbox"/>	<input type="checkbox"/>	<input type="checkbox"/>	<input type="checkbox"/>
<input type="checkbox"/>	<input type="checkbox"/>	<input type="checkbox"/>	<input type="checkbox"/>	<input type="checkbox"/>	<input type="checkbox"/>	<input type="checkbox"/>	<input type="checkbox"/>
<input type="checkbox"/>	<input type="checkbox"/>	<input type="checkbox"/>	<input type="checkbox"/>	<input type="checkbox"/>	<input type="checkbox"/>	<input type="checkbox"/>	<input type="checkbox"/>
<input type="checkbox"/>	<input type="checkbox"/>	<input type="checkbox"/>	<input type="checkbox"/>	<input type="checkbox"/>	<input type="checkbox"/>	<input type="checkbox"/>	<input type="checkbox"/>
<input type="checkbox"/>	<input type="checkbox"/>	<input type="checkbox"/>	<input type="checkbox"/>	<input type="checkbox"/>	<input type="checkbox"/>	<input type="checkbox"/>	<input type="checkbox"/>
<input type="checkbox"/>	<input type="checkbox"/>	<input type="checkbox"/>	<input type="checkbox"/>	<input type="checkbox"/>	<input type="checkbox"/>	<input type="checkbox"/>	<input type="checkbox"/>
<input type="checkbox"/>	<input type="checkbox"/>	<input type="checkbox"/>	<input type="checkbox"/>	<input type="checkbox"/>	<input type="checkbox"/>	<input type="checkbox"/>	<input type="checkbox"/>
<input type="checkbox"/>	<input type="checkbox"/>	<input type="checkbox"/>	<input type="checkbox"/>	<input type="checkbox"/>	<input type="checkbox"/>	<input type="checkbox"/>	<input type="checkbox"/>
<input type="checkbox"/>	<input type="checkbox"/>	<input type="checkbox"/>	<input type="checkbox"/>	<input type="checkbox"/>	<input type="checkbox"/>	<input type="checkbox"/>	<input type="checkbox"/>
<input type="checkbox"/>	<input type="checkbox"/>	<input type="checkbox"/>	<input type="checkbox"/>	<input type="checkbox"/>	<input type="checkbox"/>	<input type="checkbox"/>	<input type="checkbox"/>
<input type="checkbox"/>	<input type="checkbox"/>	<input type="checkbox"/>	<input type="checkbox"/>	<input type="checkbox"/>	<input type="checkbox"/>	<input type="checkbox"/>	<input type="checkbox"/>
<input type="checkbox"/>	<input type="checkbox"/>	<input type="checkbox"/>	<input type="checkbox"/>	<input type="checkbox"/>	<input type="checkbox"/>	<input type="checkbox"/>	<input type="checkbox"/>
<input type="checkbox"/>	<input type="checkbox"/>	<input type="checkbox"/>	<input type="checkbox"/>	<input type="checkbox"/>	<input type="checkbox"/>	<input type="checkbox"/>	<input type="checkbox"/>
<input type="checkbox"/>	<input type="checkbox"/>	<input type="checkbox"/>	<input type="checkbox"/>	<input type="checkbox"/>	<input type="checkbox"/>	<input type="checkbox"/>	<input type="checkbox"/>
<input type="checkbox"/>	<input type="checkbox"/>	<input type="checkbox"/>	<input type="checkbox"/>	<input type="checkbox"/>	<input type="checkbox"/>	<input type="checkbox"/>	<input type="checkbox"/>
<input type="checkbox"/>	<input type="checkbox"/>	<input type="checkbox"/>	<input type="checkbox"/>	<input type="checkbox"/>	<input type="checkbox"/>	<input type="checkbox"/>	<input type="checkbox"/>
<input type="checkbox"/>	<input type="checkbox"/>	<input type="checkbox"/>	<input type="checkbox"/>	<input type="checkbox"/>	<input type="checkbox"/>	<input type="checkbox"/>	<input type="checkbox"/>
<input type="checkbox"/>	<input type="checkbox"/>	<input type="checkbox"/>	<input type="checkbox"/>	<input type="checkbox"/>	<input type="checkbox"/>	<input type="checkbox"/>	<input type="checkbox"/>
<input type="checkbox"/>	<input type="checkbox"/>	<input type="checkbox"/>	<input type="checkbox"/>	<input type="checkbox"/>	<input type="checkbox"/>	<input type="checkbox"/>	<input type="checkbox"/>
<input type="checkbox"/>	<input type="checkbox"/>	<input type="checkbox"/>	<input type="checkbox"/>	<input type="checkbox"/>	<input type="checkbox"/>	<input type="checkbox"/>	<input type="checkbox"/>
<input type="checkbox"/>	<input type="checkbox"/>	<input type="checkbox"/>	<input type="checkbox"/>	<input type="checkbox"/>	<input type="checkbox"/>	<input type="checkbox"/>	<input type="checkbox"/>
<input type="checkbox"/>	<input type="checkbox"/>	<input type="checkbox"/>	<input type="checkbox"/>	<input type="checkbox"/>	<input type="checkbox"/>	<input type="checkbox"/>	<input type="checkbox"/>
<input type="checkbox"/>	<input type="checkbox"/>	<input type="checkbox"/>	<input type="checkbox"/>	<input type="checkbox"/>	<input type="checkbox"/>	<input type="checkbox"/>	<input type="checkbox"/>
<input type="checkbox"/>	<input type="checkbox"/>	<input type="checkbox"/>	<input type="checkbox"/>	<input type="checkbox"/>	<input type="checkbox"/>	<input type="checkbox"/>	<input type="checkbox"/>
<input type="checkbox"/>	<input type="checkbox"/>	<input type="checkbox"/>	<input type="checkbox"/>	<input type="checkbox"/>	<input type="checkbox"/>	<input type="checkbox"/>	<input type="checkbox"/>
<input type="checkbox"/>	<input type="checkbox"/>	<input type="checkbox"/>	<input type="checkbox"/>	<input type="checkbox"/>	<input type="checkbox"/>	<input type="checkbox"/>	<input type="checkbox"/>
<input type="checkbox"/>	<input type="checkbox"/>	<input type="checkbox"/>	<input type="checkbox"/>	<input type="checkbox"/>	<input type="checkbox"/>	<input type="checkbox"/>	<input type="checkbox"/>
<input type="checkbox"/>	<input type="checkbox"/>	<input type="checkbox"/>	<input type="checkbox"/>	<input type="checkbox"/>	<input type="checkbox"/>	<input type="checkbox"/>	<input type="checkbox"/>
<input type="checkbox"/>	<input type="checkbox"/>	<input type="checkbox"/>	<input type="checkbox"/>	<input type="checkbox"/>	<input type="checkbox"/>	<input type="checkbox"/>	<input type="checkbox"/>
<input type="checkbox"/>	<input type="checkbox"/>	<input type="checkbox"/>	<input type="checkbox"/>	<input type="checkbox"/>	<input type="checkbox"/>	<input type="checkbox"/>	<input type="checkbox"/>
<input type="checkbox"/>	<input type="checkbox"/>	<input type="checkbox"/>	<input type="checkbox"/>	<input type="checkbox"/>	<input type="checkbox"/>	<input type="checkbox"/>	<input type="checkbox"/>
<input type="checkbox"/>	<input type="checkbox"/>	<input type="checkbox"/>	<input type="checkbox"/>	<input type="checkbox"/>	<input type="checkbox"/>	<input type="checkbox"/>	<input type="checkbox"/>
<input type="checkbox"/>	<input type="checkbox"/>	<input type="checkbox"/>	<input type="checkbox"/>	<input type="checkbox"/>	<input type="checkbox"/>	<input type="checkbox"/>	<input type="checkbox"/>
<input type="checkbox"/>	<input type="checkbox"/>	<input type="checkbox"/>	<input type="checkbox"/>	<input type="checkbox"/>	<input type="checkbox"/>	<input type="checkbox"/>	<input type="checkbox"/>
<input type="checkbox"/>	<input type="checkbox"/>	<input type="checkbox"/>	<input type="checkbox"/>	<input type="checkbox"/>	<input type="checkbox"/>	<input type="checkbox"/>	<input type="checkbox"/>
<input type="checkbox"/>	<input type="checkbox"/>	<input type="checkbox"/>	<input type="checkbox"/>	<input type="checkbox"/>	<input type="checkbox"/>	<input type="checkbox"/>	<input type="checkbox"/>
<input type="checkbox"/>	<input type="checkbox"/>	<input type="checkbox"/>	<input type="checkbox"/>	<input type="checkbox"/>	<input type="checkbox"/>	<input type="checkbox"/>	<input type="checkbox"/>
<input type="checkbox"/>	<input type="checkbox"/>	<input type="checkbox"/>	<input type="checkbox"/>	<input type="checkbox"/>	<input type="checkbox"/>	<input type="checkbox"/>	<input type="checkbox"/>
<input type="checkbox"/>	<input type="checkbox"/>	<input type="checkbox"/>	<input type="checkbox"/>	<input type="checkbox"/>	<input type="checkbox"/>	<input type="checkbox"/>	<input type="checkbox"/>
<input type="checkbox"/>	<input type="checkbox"/>	<input type="checkbox"/>	<input type="checkbox"/>	<input type="checkbox"/>	<input type="checkbox"/>	<input type="checkbox"/>	<input type="checkbox"/>
<input type="checkbox"/>	<input type="checkbox"/>	<input type="checkbox"/>	<input type="checkbox"/>	<input type="checkbox"/>	<input type="checkbox"/>	<input type="checkbox"/>	<input type="checkbox"/>
<input type="checkbox"/>	<input type="checkbox"/>	<input type="checkbox"/>	<input type="checkbox"/>	<input type="checkbox"/>	<input type="checkbox"/>	<input type="checkbox"/>	<input type="checkbox"/>
<input type="checkbox"/>	<input type="checkbox"/>	<input type="checkbox"/>	<input type="checkbox"/>	<input type="checkbox"/>	<input type="checkbox"/>	<input type="checkbox"/>	<input type="checkbox"/>
<input type="checkbox"/>	<input type="checkbox"/>	<input type="checkbox"/>	<input type="checkbox"/>	<input type="checkbox"/>	<input type="checkbox"/>	<input type="checkbox"/>	<input type="checkbox"/>
<input type="checkbox"/>	<input type="checkbox"/>	<input type="checkbox"/>	<input type="checkbox"/>	<input type="checkbox"/>	<input type="checkbox"/>	<input type="checkbox"/>	<input type="checkbox"/>
<input type="checkbox"/>	<input type="checkbox"/>	<input type="checkbox"/>	<input type="checkbox"/>	<input type="checkbox"/>	<input type="checkbox"/>	<input type="checkbox"/>	<input type="checkbox"/>
<input type="checkbox"/>	<input type="checkbox"/>	<input type="checkbox"/>	<input type="checkbox"/>	<input type="checkbox"/>	<input type="checkbox"/>	<input type="checkbox"/>	<input type="checkbox"/>
<input type="checkbox"/>	<input type="checkbox"/>	<input type="checkbox"/>	<input type="checkbox"/>	<input type="checkbox"/>	<input type="checkbox"/>	<input type="checkbox"/>	<input type="checkbox"/>
<input type="checkbox"/>	<input type="checkbox"/>	<input type="checkbox"/>	<input type="checkbox"/>	<input type="checkbox"/>	<input type="checkbox"/>	<input type="checkbox"/>	<input type="checkbox"/>
<input type="checkbox"/>	<input type="checkbox"/>	<input type="checkbox"/>	<input type="checkbox"/>	<input type="checkbox"/>	<input type="checkbox"/>	<input type="checkbox"/>	<input type="checkbox"/>
<input type="checkbox"/>	<input type="checkbox"/>	<input type="checkbox"/>	<input type="checkbox"/>	<input type="checkbox"/>	<input type="checkbox"/>	<input type="checkbox"/>	<input type="checkbox"/>
<input type="checkbox"/>	<input type="checkbox"/>	<input type="checkbox"/>	<input type="checkbox"/>	<input type="checkbox"/>	<input type="checkbox"/>	<input type="checkbox"/>	<input type="checkbox"/>
<input type="checkbox"/>	<input type="checkbox"/>	<input type="checkbox"/>	<input type="checkbox"/>	<input type="checkbox"/>	<input type="checkbox"/>	<input type="checkbox"/>	<input type="checkbox"/>
<input type="checkbox"/>	<input type="checkbox"/>	<input type="checkbox"/>	<input type="checkbox"/>	<input type="checkbox"/>	<input type="checkbox"/>	<input type="checkbox"/>	<input type="checkbox"/>
<input type="checkbox"/>	<input type="checkbox"/>	<input type="checkbox"/>	<input type="checkbox"/>	<input type="checkbox"/>	<input type="checkbox"/>	<input type="checkbox"/>	<input type="checkbox"/>
<input type="checkbox"/>	<input type="checkbox"/>	<input type="checkbox"/>	<input type="checkbox"/>	<input type="checkbox"/>	<input type="checkbox"/>	<input type="checkbox"/>	<input type="checkbox"/>
<input type="checkbox"/>	<input type="checkbox"/>	<input type="checkbox"/>	<input type="checkbox"/>	<input type="checkbox"/>	<input type="checkbox"/>	<input type="checkbox"/>	<input type="checkbox"/>
<input type="checkbox"/>	<input type="checkbox"/>	<input type="checkbox"/>	<input type="checkbox"/>	<input type="checkbox"/>	<input type="checkbox"/>	<input type="checkbox"/>	<input type="checkbox"/>
<input type="checkbox"/>	<input type="checkbox"/>	<input type="checkbox"/>	<input type="checkbox"/>	<input type="checkbox"/>	<input type="checkbox"/>	<input type="checkbox"/>	<input type="checkbox"/>
<input type="checkbox"/>	<input type="checkbox"/>	<input type="checkbox"/>	<input type="checkbox"/>	<input type="checkbox"/>	<input type="checkbox"/>	<input type="checkbox"/>	<input type="checkbox"/>
<input type="checkbox"/>	<input type="checkbox"/>	<input type="checkbox"/>	<input type="checkbox"/>	<input type="checkbox"/>	<input type="checkbox"/>	<input type="checkbox"/>	<input type="checkbox"/>
<input type="checkbox"/>	<input type="checkbox"/>	<input type="checkbox"/>	<input type="checkbox"/>	<input type="checkbox"/>	<input type="checkbox"/>	<input type="checkbox"/>	<input type="checkbox"/>
<input type="checkbox"/>	<input type="checkbox"/>	<input type="checkbox"/>	<input type="checkbox"/>	<input type="checkbox"/>	<input type="checkbox"/>	<input type="checkbox"/>	<input type="checkbox"/>
<input type="checkbox"/>	<input type="checkbox"/>	<input type="checkbox"/>	<input type="checkbox"/>	<input type="checkbox"/>	<input type="checkbox"/>	<input type="checkbox"/>	<input type="checkbox"/>
<input type="checkbox"/>	<input type="checkbox"/>	<input type="checkbox"/>	<input type="checkbox"/>	<input type="checkbox"/>	<input type="checkbox"/>	<input type="checkbox"/>	<input type="checkbox"/>
<input type="checkbox"/>	<input type="checkbox"/>	<input type="checkbox"/>	<input type="checkbox"/>	<input type="checkbox"/>	<input type="checkbox"/>	<input type="checkbox"/>	<input type="checkbox"/>
<input type="checkbox"/>	<input type="checkbox"/>	<input type="checkbox"/>	<input type="checkbox"/>	<input type="checkbox"/>	<input type="checkbox"/>	<input type="checkbox"/>	<input type="checkbox"/>
<input type="checkbox"/>	<input type="checkbox"/>	<input type="checkbox"/>	<input type="checkbox"/>	<input type="checkbox"/>	<input type="checkbox"/>	<input type="checkbox"/>	<input type="checkbox"/>
<input type="checkbox"/>	<input type="checkbox"/>	<input type="checkbox"/>	<input type="checkbox"/>	<input type="checkbox"/>	<input type="checkbox"/>	<input type="checkbox"/>	<input type="checkbox"/>
<input type="checkbox"/>	<input type="checkbox"/>	<input type="checkbox"/>	<input type="checkbox"/>	<input type="checkbox"/>	<input type="checkbox"/>	<input type="checkbox"/>	<input type="checkbox"/>
<input type="checkbox"/>	<input type="checkbox"/>	<input type="checkbox"/>	<input type="checkbox"/>	<input type="checkbox"/>	<input type="checkbox"/>	<input type="checkbox"/>	<input type="checkbox"/>
<input type="checkbox"/>	<input type="checkbox"/>	<input type="checkbox"/>	<input type="checkbox"/>	<input type="checkbox"/>	<input type="checkbox"/>	<input type="checkbox"/>	<input type="checkbox"/>
<input type="checkbox"/>	<input type="checkbox"/>	<input type="checkbox"/>	<input type="checkbox"/>	<input type="checkbox"/>	<input type="checkbox"/>	<input type="checkbox"/>	<input type="checkbox"/>
<input type="checkbox"/>	<input type="checkbox"/>	<input type="checkbox"/>	<input type="checkbox"/>	<input type="checkbox"/>	<input type="checkbox"/>	<input type="checkbox"/>	<input type="checkbox"/>
<input type="checkbox"/>	<input type="checkbox"/>	<input type="checkbox"/>	<input type="checkbox"/>	<input type="checkbox"/>	<input type="checkbox"/>	<input type="checkbox"/>	<input type="checkbox"/>
<input type="checkbox"/>	<input type="checkbox"/>	<input type="checkbox"/>	<input type="checkbox"/>	<input type="checkbox"/>	<input type="checkbox"/>	<input type="checkbox"/>	<input type="checkbox"/>
<input type="checkbox"/>	<input type="checkbox"/>	<input type="checkbox"/>	<input type="checkbox"/>	<input type="checkbox"/>	<input type="checkbox"/>	<input type="checkbox"/>	<input type="checkbox"/>
<input type="checkbox"/>	<input type="checkbox"/>	<input type="checkbox"/>	<input type="checkbox"/>	<input type="checkbox"/>	<input type="checkbox"/>	<input type="checkbox"/>	<input type="checkbox"/>
<input type="checkbox"/>	<input type="checkbox"/>	<input type="checkbox"/>	<input type="checkbox"/>	<input type="checkbox"/>	<input type="checkbox"/>	<input type="checkbox"/>	<input type="checkbox"/>
<input type="checkbox"/>	<input type="checkbox"/>	<input type="checkbox"/>	<input type="checkbox"/>	<input type="checkbox"/>	<input type="checkbox"/>	<input type="checkbox"/>	<input type="checkbox"/>
<input type="checkbox"/>	<input type="checkbox"/>	<input type="checkbox"/>	<input type="checkbox"/>	<input type="checkbox"/>	<input type="checkbox"/>	<input type="checkbox"/>	<input type="checkbox"/>
<input type="checkbox"/>	<input type="checkbox"/>	<input type="checkbox"/>	<input type="checkbox"/>	<input type="checkbox"/>	<input type="checkbox"/>	<input type="checkbox"/>	<input type="checkbox"/>
<input type="checkbox"/>	<input type="checkbox"/>	<input type="checkbox"/>	<input type="checkbox"/>	<input type="checkbox"/>	<input type="checkbox"/>	<input type="checkbox"/>	<input type="checkbox"/>
<input type="checkbox"/>	<input type="checkbox"/>	<input type="checkbox"/>	<input type="checkbox"/>	<input type="checkbox"/>	<input type="checkbox"/>	<input type="checkbox"/>	<input type="checkbox"/>
<input type="checkbox"/>	<input type="checkbox"/>	<input type="checkbox"/>	<input type="checkbox"/>	<input type="checkbox"/>	<input type="checkbox"/>	<input type="checkbox"/>	<input type="checkbox"/>
<input type="checkbox"/>	<input type="checkbox"/>	<input type="checkbox"/>	<input type="checkbox"/>	<input type="checkbox"/>	<input type="checkbox"/>	<input type="checkbox"/>	<input type="checkbox"/>
<input type="checkbox"/>	<input type="checkbox"/>	<input type="checkbox"/>	<input type="checkbox"/>	<input type="checkbox"/>	<input type="checkbox"/>	<input type="checkbox"/>	<input type="checkbox"/>
<input type="checkbox"/>	<input type="checkbox"/>	<input type="checkbox"/>	<input type="checkbox"/>	<input type="checkbox"/>	<input type="checkbox"/>	<input type="checkbox"/>	<input type="checkbox"/>
<input type="checkbox"/>	<input type="checkbox"/>	<input type="checkbox"/>	<input type="checkbox"/>	<input type="checkbox"/>	<input type="checkbox"/>	<input type="checkbox"/>	<input type="checkbox"/>
<input type="checkbox"/>	<input type="checkbox"/>	<input type="checkbox"/>	<input type="checkbox"/>	<input type="checkbox"/>	<input type="checkbox"/>	<input type="checkbox"/>	<input type="checkbox"/>
<input type="checkbox"/>	<input type="checkbox"/>	<input type="checkbox"/>	<input type="checkbox"/>	<input type="checkbox"/>	<input type="checkbox"/>	<input type="checkbox"/>	<input type="checkbox"/>
<input type="checkbox"/>	<input type="checkbox"/>	<input type="checkbox"/>	<input type="checkbox"/>	<input type="checkbox"/>	<input type="checkbox"/>	<input type="checkbox"/>	<input type="checkbox"/>
<input type="checkbox"/>	<input type="checkbox"/>	<input type="checkbox"/>	<input type="checkbox"/>	<input type="checkbox"/>	<input type="checkbox"/>	<input type="checkbox"/>	<input type="checkbox"/>
<input type="checkbox"/>	<input type="checkbox"/>	<input type="checkbox"/>	<input type="checkbox"/>	<input type="checkbox"/>	<input type="checkbox"/>	<input type="checkbox"/>	<input type="checkbox"/>
<input type="checkbox"/>	<input type="checkbox"/>	<input type="checkbox"/>	<input type="checkbox"/>	<input type="checkbox"/>	<input type="checkbox"/>	<input type="checkbox"/>	<input type="checkbox"/>
<input type="checkbox"/>	<input type="checkbox"/>	<input type="checkbox"/>	<input type="checkbox"/>	<input type="checkbox"/>	<input type="checkbox"/>	<input type="checkbox"/>	<input type="checkbox"/>
<input type="checkbox"/>	<input type="checkbox"/>	<input type="checkbox"/>	<input type="checkbox"/>	<input type="checkbox"/>	<input type="checkbox"/>	<input type="checkbox"/>	<input type="checkbox"/>
<input type="checkbox"/>	<input type="checkbox"/>	<input type="checkbox"/>	<input type="checkbox"/>	<input type="checkbox"/>	<input type="checkbox"/>	<input type="checkbox"/>	<input type="checkbox"/>
<input type="checkbox"/>	<input type="checkbox"/>	<input type="checkbox"/>	<input type="checkbox"/>	<input type="checkbox"/>	<input type="checkbox"/>	<input type="checkbox"/>	<input type="checkbox"/>
<input type="checkbox"/>	<input type="checkbox"/>	<input type="checkbox"/>	<input type="checkbox"/>	<input type="checkbox"/>	<input type="checkbox"/>	<input type="checkbox"/>	<input type="checkbox"/>
<input type="checkbox"/>	<input type="checkbox"/>	<input type="checkbox"/>	<input type="checkbox"/>	<input type="checkbox"/>	<input type="checkbox"/>	<input type="checkbox"/>	<input type="checkbox"/>
<input type="checkbox"/>	<input type="checkbox"/>	<input type="checkbox"/>	<input type="checkbox"/>	<input type="checkbox"/>	<input type="checkbox"/>	<input type="checkbox"/>	<input type="checkbox"/>
<input type="checkbox"/>	<input type="checkbox"/>	<input type="checkbox"/>	<input type="checkbox"/>	<input type="checkbox"/>	<input type="checkbox"/>	<input type="checkbox"/>	<input type="checkbox"/>
<input type="checkbox"/>	<input type="checkbox"/>	<input type="checkbox"/>	<input type="checkbox"/>	<input type="checkbox"/>	<input type="checkbox"/>	<input type="checkbox"/>	<input type="checkbox"/>
<input type="checkbox"/>	<input type="checkbox"/>	<input type="checkbox"/>	<input type="checkbox"/>	<input type="checkbox"/>	<input type="checkbox"/>	<input type="checkbox"/>	<input type="checkbox"/>
<input type="checkbox"/>	<input type="checkbox"/>	<input type="checkbox"/>	<input type="checkbox"/>	<input type="checkbox"/>	<input type="checkbox"/>	<input type="checkbox"/>	<input type="checkbox"/>
<input type="checkbox"/>	<input type="checkbox"/>	<input type="checkbox"/>	<input type="checkbox"/>	<input type="checkbox"/>	<input type="checkbox"/>	<input type="checkbox"/>	<input type="checkbox"/>
<input type="checkbox"/>							

Auswahlübersicht Selection table

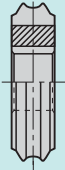
Formfräser für Verzahnung Form Milling Cutters for gears

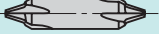
					
<ul style="list-style-type: none"> ● sehr gut geeignet well suited ○ auch geeignet also suited 			Formfräser für Kettenräder Form Milling Cutters for Sprockets	Formfräser für Zahnriemenscheiben Form Milling Cutters for timing belt pulleys	
			hinterdreht backed off	hinterdreht backed off	
Seite Page			568	569	
			Sonderformen Special tooth form		
Werkstoff	Material	R _m /UTS (N/mm ²)			
Unlegierter Baustahl	Plain carbon steel	- 700	●	●	
Automatenstahl	Free cutting steel	- 700	●	●	
Baustahl	Structural low alloy steel	500 - 950	●	●	
Vergütungsstahl, mittelfest	Heat-treatable steel, medium strength	500 - 950	●	●	
Stahlguß	Cast steel	- 950	●	●	
Einsatzstahl	Case hardening steel	- 950	●	●	
Rost- und säurebeständiger Stahl, ferritisch, martensitisch	Stainless steel, ferritic, martensitic	500 - 950	●	●	
Vergütungsstahl, hochfest	Heat-treatable steel, high strength	950 - 1400	●	●	
Nitrierstahl, vergütet	Nitriding steel	950 - 1400	●	●	
Werkzeugstahl (bis 45 HRC)	Tool steel (to 45 HRC)	950 - 1400	●	●	
Rost- und säurebeständiger Stahl, austenitisch	Stainless steel, austenitic	500 - 950			
Martensitaushärtbarer Stahl	Maraging steel				
Grauguß	Grey cast iron	100 - 400 (120 - 260 HB)	●	●	
Legierter Grauguß	Alloyed grey cast iron	150 - 250 (160 - 230 HB)	●	●	
Sphäroguß	Nodular cast iron	400 - 800 (120 - 310 HB)	●	●	
Temperguß	Malleable cast iron	350 - 700 (150 - 280 HB)	●	●	
Rein-Metalle, weich	Pure metals, soft	- 500	○	○	
Aluminium-Legierungen, langspanend	Aluminium alloys, long chipping	- 550	○	○	
Aluminium-Legierungen, kurzspanend	Aluminium alloys, short chipping	- 400	○	○	
Kupfer-Legierungen, langspanend	Copper alloys, long chipping	300 - 700	○	○	
Kupfer-Legierungen, kurzspanend	Copper alloys, short chipping	- 500	○	○	
Magnesium-Legierungen	Magnesium alloys	150 - 300	○	○	
Thermoplaste	Thermoplastics	40 - 70	○	○	
Duroplaste	Duroplastics	20 - 40	○	○	
Graphit	Graphite				
Titanlegierungen, mittelfest	Titanium alloys, medium strength	- 950	○	○	
Titanlegierungen, hochfest	Titanium alloys, high strength	900 - 1400	○	○	
Nickelbasislegierungen, mittelfest	Nickel based alloys, medium strength	- 950	○	○	
Nickelbasislegierungen, hochwarmfest	Heat resistant nickel based alloys, high strength	900 - 1400	○	○	
Hartguß	Chilled cast iron	300 - 600	○	○	
gehärteter Stahl	hardened steel				

						
Formfräser für Keilwellenprofile Form Milling Cutters for spline shaft profiles hinterdreht oder hinterschliften relief ground or backed off	Formfräser für Keil- und Zahnwellen als Satzfräser Form Milling Cutters for straight-sided and involute spline shafts hinterdreht backed off	mit geraden Flanken, hinterschliften with straight flanks, relief ground	mit geschweiften Flanken, hinterschliften with curved flanks, relief ground Sonderform Specially Form	Formfräser für Kerbschlagbiegeprobe Form Milling Cutters for notched-bar impact tests hinterschliften relief ground	Trapezgewindefräser; Trapezoidal Thread Milling Cutters	
570	574	575	575	576	577	578
Sonderformen Special tooth form		Zahn-Abrundfräser Gear Chamfering Cutters		Formfräser für Kerbschlagbiegeprobe Form Milling Cutters for notched-bar impact tests	Gewinde-Scheibenfräser Thread and Side Milling Cutters	Gewinde-Aufsteckfräser Shell-Type Thread Milling Cutters
●	●	●	●	●	●	●
●	●	●	●	●	●	●
●	●	●	●	●	●	●
●	●	●	●	●	●	●
●	●	●	●	●	●	●
●	●	●	●	●	○	○
●	●	●	●	●	○	○
●	●	●	●	●	○	○
				●	○	○
				●	○	○
●	●	●	●	●	●	●
●	●	●	●	●	●	●
●	●	●	●	●	●	●
●	●	●	●	●	●	●
○	○	○	○	●	○	○
○	○	○	○	●	○	○
○	○	○	○	●	●	●
○	○	○	○	●	●	●
○	○	○	○	●	●	●
○	○	○	○	●	○	○
○	○	○	○	●	○	○
○	○	○	○	●	○	○
○	○	○	○	●	○	○
○	○	○	○	●	○	○
○	○	○	○	●	○	○
○	○	○	○	●	○	○

Typenbeschreibung Type description

Formfräser Form Milling Cutters

	Formfräser mit Schaft Form Milling Cutters with Shank	DIN (WN = Werknorm Fette Standard)	Cat.-No.	TiCN Plus	Seite Page
 <p>Typ N</p>	Schafffräser für T-Nuten DIN 650 kreuzverzahnt Drallwinkel $\approx 12^\circ$ Spanwinkel $\approx 11^\circ$. T-Slot Milling Cutters to DIN 650 staggered tooth $\approx 12^\circ$ helix angle $\approx 11^\circ$ rake angle.	851 AA	1601	●	545
		851 AB	1602	●	
		851 AD	1603	●	
 <p>Typ NF</p>	Schafffräser für T-Nuten DIN 650 mit Schrupp-Schlichtgewinde $\approx 25^\circ$ Rechtsdrall. T-Slot Milling Cutters to DIN 650 with truncated type for roughing $\approx 25^\circ$ R. H. spiral.	851 AA	1605	●	546
		851 AB	1606	●	
		851 AD	1607	●	
 <p>Typ N</p>	Schlitzfräser für Nuten nach DIN 6888, Passung P 9, DIN 850 Form B, D und F, kreuzverzahnt, Typ N, Drallwinkel $\approx 8^\circ$. Woodruff Keyseat Cutters for Keyways to DIN 6888, P 9 fit; DIN 850 form B, D, and F, staggered tooth, type N, helix angle $\approx 8^\circ$.	850 B	1641	●	547
		850 D/F	1643	●	
 <p>Typ N</p>	Winkelfräser, grob gezahnt Form C und E stirnseitig und am Umfang schneidend, drallgenutet, Form D und F nur am Umfang schneidend. Angle Milling Cutters, coarse-tooth; Form C and E cutting on periphery and face. Form D and F cutting on periphery only, spiral fluted.	\approx 1833 C/E	1661	●	548
		\approx 1833 D/F	1662	●	
 <p>Typ H</p>	Winkelfräser feinverzahnt Form A und C am Umfang und an der Stirnseite schneidend Form B und D nur am Umfang schneidend. Angle Milling Cutters fine tooth Form A and C cutting on periphery and face Form B and D cutting on periphery only.	1833 A	1651	●	549
		1833 C	1653	●	
		1833 B	1652	●	
		1833 D	1654	●	
	Viertelrund-Profilfräser, konkav, radial-axial hinterdreht positiver Spanwinkel $\approx 5^\circ$ Axialwinkel. Corner Rounding Milling Cutters, concave, backed off radially and axially positive rake angle $\approx 5^\circ$ axial angle.	6518 B/D	1664	●	550

● = Diese Standardausführung ist auch TiCN Plus beschichtet lieferbar.
This standard design is also available TiCN Plus coated.

Typenbeschreibung Type description

Formfräser Form Milling Cutters

	Formfräser mit Bohrung Form Milling Cutters with bore	DIN	Cat.-No.	Seite Page
Typ H 	Aufsteck-Winkelfräser gerade verzahnt, Fasenschliff, Spanwinkel 3°, Fräserwinkel 45° ... 60° Shell Type Milling Cutters straight tooth, relieved land, rake angle 3°, cutter angle 45° ... 60°	842	1302	551
Typ NF 	Aufsteck-Winkelstirnfräser Schrupp-Schlichtverzahnung, ≈ 25° Rechtsdrall (konst.), Spanwinkel 11°, Fräserwinkel 45° ... 60° Shell Type Milling Cutters truncated type for roughing, ≈ 25° R.H. spiral (const.), rake angle 11°, cutter angle 45° ... 60°	≈ 842	1305	552
Typ H 	Prismenfräser gefräste Ausführung, Fasenschliff, Spanwinkel 0°, Fräserwinkel 45° ... 120° Double Angle Milling Cutters, symmetrically relieved land, rake angle 0°, cutter angle 45° ... 120°	847	1322	553
Typ N 	Halbrund-Profilfräser konvex, radial-hinterdreht, Spanwinkel 8° Form-Relieved Convex Cutters radially backed off, rake angle 8°	856	1371	554
	Halbrund-Profilfräser konvex, radial-hinterdreht, extra große Fräser-Ø, Spanwinkel 5° Form-Relieved Convex Cutters radially backed off, special large cutter Dia., rake angle 5°	≈ 856	1372	555
Typ N 	Halbrund-Profilfräser konkav, radial-hinterdreht, Spanwinkel 8° Form-Relieved Concave Cutters radially backed off, rake angle 8°	855	1381	556
Typ N 	Viertelrund-Profilfräser konkav, radial-axial-hinterdreht, Spanwinkel 8° Form-Relieved Concave Cutters radially axially backed off, rake angle 8°	6513	1391	557

Typenbeschreibung Type description

Formfräser Form Milling Cutters

	Formfräser für Verzahnung Form Milling Cutters for Gears	Cat.-No.	Seite Page
	<p>Schneckenfräser für Steigungen nach Modul, geradeverzahnt, gefräst Eingriffswinkel 20°, Bezugsprofil I nach DIN 3972 mit versetzten Zähnen und einem Meßzahn. Auch als Zahnform-Vorfräser und Zahnstangenfräser verwendbar.</p> <p>Worm Cutters for module pitch, straight tooth, milled 20° pressure angle, basic profile I to DIN 3972 with offset teeth and one tooth for checking. This design can also be used as a gear milling cutter for roughing and as a rack tooth cutter.</p>	2500	558
	<p>Zahnstangenfräser/Schneckenfräser für Steigungen nach Modul kreuzverzahnt, gefräst Eingriffswinkel 20°, Bezugsprofil I nach DIN 3972 mit einem Meßzahn</p> <p>Rack and Worm Cutters for module pitch staggered tooth, milled 20° pressure angle Basic profile I to DIN 3972 with offset teeth</p>	2512	559
	<p>Schnecken-Vorfräser, kreuzverzahnt, gefräst zum Vorfräsen von Zahnrädern, Zahnstangen und Schnecken nach Modul Eingriffswinkel 20°, gerade Flanken, Bezugsprofil IV nach DIN 3972 ohne Meßzahn, versetzte Spanbrecher ab Modul 10. Diese Fräser sind ausgelegt für das geradflankige Vorfräsen von Zahnrädern, Zahnstangen und Schnecken. Sie werden zur Erzielung hoher Schnittleistungen ohne Meßzahn ausgeliefert. Das Schärfen erfolgt durch Nachsetzen des Profils an den Freiflächen.</p> <p>Worm Cutters for Roughing, staggered tooth, milled for roughing gears, tooth racks and worms of module pitch 20° pressure angle, straight flanks, basic profile IV to DIN 3972 without tooth for checking, staggered chip breakers form module 10. These milling cutters are designed for the straight flank roughing of gears, racks and worms. They are manufactured without a tooth for checking, to achieve a high cutting rate. They are sharpened by tracing the profile at the backed-off surfaces.</p>	2513	560
	<p>Zahnstangenfräser/Schneckenfräser, geradeverzahnt, hinterschliften Steigung nach Modul, Eingriffswinkel 20° Bezugsprofil I nach DIN 3972 Form A: mit geradem Profil Form B: mit 10° geneigtem Profil</p>	2521	591
	<p>Rack Cutters/Worm Cutters, straight tooth, relief turned Module pitch, 20° pressure angle Basic profile I to DIN 3972 Form A: with straight profile Form B: with 10° inclined profile</p>	2522	562
	<p>Zahnformfräser, hinterdreht für Stirnräder nach Modul Eingriffswinkel 20°, Bezugsprofil I nach DIN 3972 Satzeinteilung von Modul 0,3 bis Modul 10 in Sätzen zu 8 Stück von Modul 11 bis Modul 20 in Sätzen zu 15 Stück</p> <p>Involute Gear Cutters, backed off for spur gears to module pitch 20° pressure angle, Basic profile I to DIN 3972 Specification of sets from module 0,3 to module 10 in sets of 8 units from module 11 to module 20 in sets of 15 units</p>	2601	563

Typenbeschreibung Type description

Formfräser Form Milling Cutters

	Formfräser für Verzahnung Form Milling Cutters for Gears	Cat.-No.	Seite Page
	Zahnform-Fingerfräser (Vorfräser) gefräst, geschliffen für Zahnräder und Zahnstangen, Eingriffswinkel 20°. Bezugsprofil IV nach DIN 3972 mit geraden Flanken, spiral genutet, mit Innengewinde und Zentrierung zum Aufschrauben, 2 Schlüsselflächen. End Mill Type Gear Cutter (Roughing Cutters) milled and ground for gears and racks 20° pressure angle. Basic profile IV to DIN 3972 with straight flanks, spiral fluted, with female thread and centring, for screw-on, 2 spanner flats.	2620	565
	Zahnform-Fingerfräser (Fertigfräser) hinterdreht, mit Profillasenschliff, Evolventenprofil Eingriffswinkel 20°, Bezugsprofil I oder II nach DIN 3972 geradegenutet, mit Innengewinde und Zentrierbohrung zum Aufschrauben, 2 Schlüsselflächen. Zur Erzielung hoher Profiligenauigkeit und Oberflächengüte erhalten die Fräser einen Profillasenschliff. Für die Instandhaltung liefern wir auf Wunsch Prüflehren und Schleifschablonen für Werkzeugschleif-Maschinen: Studer-Oerlikon, Aldridge oder Schütte. Bezugszylinder für die Profilprüfung ist der geschliffene Fräseraußendurchmesser. End Mill Type Gear Cutters (Finishing Cutters) backed off, with ground profile land, Involute profile 20° pressure angle, Basic profile I or II to DIN 3972 straight fluted, with female thread and centre bore, for screw-on, 2 spanner flats. To achieve high profile and surface quality, the cutters are ground with a profile land. For maintenance we supply, if required, checking gauges and grinding templates for tool grinding machines: Studer-Oerlikon, Aldridge or Schuette. The reference cylinder for checking the profile is the ground outside diameter of the cutter.	2621	566
	Zahnform-Vorfräser, hinterdreht stufenförmig, Eingriffswinkel 20° wechselseitig schneidend mit Längsnut. Das stufenförmige Vorzerspanen ist ein in der Praxis bewährtes Verfahren bei Verzahnungsgrößen über Modul 10. Die Fräserausführung zeichnet sich durch relativ geringen Kraftbedarf aus, da die Spanbildung an den Stufen nur in Umfangsrichtung erfolgt und fast keine Seitenbelastung auftritt. Hinzu kommt die relativ einfache Instandhaltung durch Spanflächenschleifen. Bei ausreichender Maschinenleistung können die Fräser auch als Satzfräser für die gleichzeitige Bearbeitung von zwei nebeneinanderliegenden Zahn-lücken eingesetzt werden. Aus der Praxis haben sich für stufenförmige Zahnformen-Vorfräser zwei Bau-maßreihen ergeben. Es können aber auch Sonderwünsche bei den Fräserabmessungen berücksichtigt werden. Fräseraußendurchmesser. Circular Type Gear Roughing Cutters, backed off, stepped-up type 20° pressure angle alternate cutting with keyway. Stepped-up pre-machining is a process well-tried in practice for gear sizes above 10 module. An advantage of this cutter design is the relatively low power requirement as the chips are at the steps only formed in the direction of the circumference and hardly any lateral loads are occurring. Another feature is the relatively simple maintenance by tool face grinding. When enough machine power is available, these cutters can also be used as gang cutters for simultaneous machining of two adjacent tooth gaps. Two overall dimension series have been established in practice for stepped-up roughing cutters. Special dimensional requirements can however also be taken into account with these cutters.	2630	567
	Formfräser, hinterdreht, für Kettenräder zu Rollen- und Hülsenketten, nach DIN 8187, 8188. Satzenteilung in Sätzen zu 5 Stück. Form Milling Cutters, backed off, for sprockets for roller- and barrel chains, to DIN 8187, 8188. Specification of sets in sets of 5 units.	2701	568
	Formfräser, hinterdreht für Zahnriemenscheiben, halb-überschneidend, positiver Spanwinkel, für metrische Teilungen nach DIN 7721, für Zoll-Teilungen nach DIN ISO 5294. Form Milling Cutters, backed off for timing belt pulleys, semi-topping, positive rake angle, for metric pitches to DIN 7721, for inch pitches to DIN 5294.	2742	569

Typenbeschreibung Type description

Formfräser Form Milling Cutters

	Formfräser für Verzahnung Form Milling Cutters for Gears	Cat.-No.	Seite Page
	<p>Formfräser für Keilwellenprofile werden in hinterdreher oder für erhöhte Genauigkeit auch in profilhinterschliffener Ausführung gefertigt. Auch Satzfräser für das gleichzeitige Fräsen mehrerer Werkstücke auf Keilwellenfräsautomaten sind lieferbar. Je nach Verwendungszweck werden die Fräser als Vor- oder Fertigfräser ausgelegt. Genormte Keilwellenverzahnungen sind u. a.:</p> <p>DIN 5462 – leichte Reihe, DIN 5463 – mittlere Reihe, DIN 5464 – schwere Reihe DIN 5471 – 4 Keile, innenzentriert, DIN 5472 – 6 Keile, innenzentriert, DIN 9611 – Zapfwellen</p> <p>Form Milling Cutters for Spline Shaft Profiles are supplied relief turned or for increased accuracy also profile ground. Gang cutters for the simultaneous machining of several workpieces on automatic spline shaft milling machines are also available. The cutters are designed as roughing- or finishing cutters, depending on the type of application. Standardized spline shafts comprise, among others:</p> <p>DIN 5462 – light series, DIN 5463 – medium series, DIN 5464 – heavy series DIN 5471 – 4 splines, internally centred, DIN 5472 – 6 splines, internally centred, DIN 9611 – p.t.o. shafts</p>	2730	570
	<p>Formfräser, hinterschliffen für Keilwellen und Zahnwellen als Satzfräser, 6° positiver Spanwinkel, versetzte Keilnuten, 1 Satz = 2 Stück, Fräser Nr. 2 mit 2 Längsnuten.</p> <p>Diese Fräserausführung wird vorwiegend bei Serienfertigung von Steckverzahnungen auf Keilwellenfräsautomaten (z.B. Typ Hurth) eingesetzt. Die Fräser sind innerhalb des Satzes auf genaue Breite, Profilsymmetrie und gleiche Außendurchmesser in engen Toleranzen geschliffen. Fräser Nr. 2 eines Satzes erhält eine zweite Längsnut, die um 1/2 Zahnteilung versetzt ist. Haupteinsatzgebiete sind Keilwellen mit parallelen Flanken sowie Zahnwellen mit Evolventenflanken.</p> <p>Form Milling Cutters, relief ground for straight sided and involute spline shafts, designed as gang cutters 6° positive rake angle, staggered keyways, 1 set (gang) equals 2 units, Cutter No. 2 with 2 keyways. This cutter design is mainly used for the batch production of slip gears on automatic spline shaft milling machines (e.g. Hurth type). Within the set the cutters are precision ground for exact width, profile symmetry and equal outside diameters to close tolerances. Cutter No. 2 of a set is given a second keyway, which is offset by 1/2 tooth pitch. The main fields of application are spline shafts with parallel flanks as well as shafts with involute flanks.</p>	2731	574
	<p>Zahn-Abrundfräser zum Abrunden von Zahnkanten, mit geraden Flanken, hinterschliffen, mit geschweiften Flanken, hinterschliffen, mit außen profilierten Schneiden für Halbkreis oder dachförmige Abrundungen innenliegend profiliert, als Glockenfräser</p> <p>Gear Chamfering Cutters for chamfering tooth edges with straight flanks, relief ground, with curved flanks, relief ground, flutes profiled on the outside for half circles or roof-form round offs as bell-shaped cutter</p>	2801 2802 2803 2804	575
	<p>Formfräser für Kerbschlagbiegeproben, radial-hinterschliffen, Spanwinkel 5° Typ A für ISO-Spitzkerbprobe Typ B für ISO-Rundkerbprobe</p> <p>Form Milling Cutters, for notched bar impact tests, radial relief ground, Rake angle 5° Type A for ISO-notch sample Type B for ISO ball-notch</p>	1324 A 1324 B	576
	<p>Trapezgewindefräser, Scheibenfräser, Ausführung gefräst mit Fasenschliff, mit versetzten Zähnen und einem Meßzahn. Standardausführung: z = 30. Zur Herstellung von Zahnstangen und Trapezgewinden nach DIN 103. Flankenwinkel 30°, Steigung in mm. Andere Flankenwinkel (z. B. 29° oder 40°) oder auch für Steigungen nach Modul, auf Anfrage.</p> <p>Trapezoidal Thread Milling Cutters, designed with ground relieved land and staggered tooth and one tooth with gauging point. Standard design: 30 teeth. Used to produce trapezoidal form threads and tooth racks according to standard DIN 103, flank angle 30°, pitch in mm. Other flank angles (for instance 29° or 40°) or also for other pitches according to module specification, available on request.</p>	1810	577
	<p>Aufsteck-Gewindefräser, geradegenutet mit beidseitiger zylindrischer Eindrehung; hinterschliffen. Für metrisches ISO-Gewinde DIN 13. Für Außengewinde (Bolzenschrauben) oder Innengewinde (Muttergewinde). Bei Verwendung des Werkzeugkorrekturspeichers der Maschine bleibt das NC-Programm immer gleich. Unterschiedliche Gewindenenn-Ø oder Auf-/Untermaße werden über die Ø-Korrektur erzeugt, größere Gewindelängen durch Änderung im Längenkorrekturspeicher nach dem ersten Zyklus.</p> <p>Shell-Type Thread Milling Cutters, straight flute, with cylindrical recess on both faces. For metric ISO-thread to DIN 13. For external (male) threads and internal (female) threads. By applying the tool corrective memory of the machine, the NC-programme remains always the same. Differentiating thread nominal Ø or oversize-/undersize dimensions are generated by way of diameter correction, longer thread lengths are effected by changes in the length corrective memory, after the first cycle.</p>	1703	578

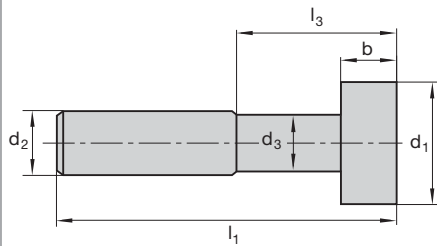

Katalog-Nr.	Cat.-No.	1601	1602	1603
Typ	Type	N		
Norm	Standard	DIN 851 AA	DIN 851 AB	DIN 851 AD
Drallwinkel	Helix angle	≈ 12° kreuzverzahnt staggered tooth		
Zylinderschaft	Straight shank	DIN 1835 A	DIN 1835 B	DIN 1835 D
Beschichtung	Coating	-		
Werkstoff	Material	HSS-E EMo5Co5		

d ₁ , d ₁₁	b, d ₁₁	für T-Nuten for T-Slots	l ₁	l ₃	d ₂ h 6	d ₃	z	Ident No.	Ident No.	Ident No.
12,5	6	6	57	17	10	5	6	1175919	1176053	1176918
16	8	8	62	22	10	7	6	1175928	1176062	1176927
18	8	10	70	25	12	8	6	1175937	1176071	1176936
19	9	10	71	26	12	8	6	1175946	1176080	1176945
21	9	12	74	29	12	10	8	1175955	1176099	1176954
22	10	12	75	30	12	10	8	1175964	1176106	1176963
25	11	14	82	34	16	12	8	1175982	1176115	1176972
28	12	16	85	37	16	13	8	1175991	1176124	1176981
32	14	18	90	42	16	15	8	1176008	1176133	1176990
36	16	20	103	47	25	17	10	1176017	1176685	1177007
40	18	22	108	52	25	19	10	1176026	1176687	1177016
45	20	24	113	57	25	21	10	1176035	1176689	1177025
50	22	28	124	64	32	25	12	1176044	-	1177034

Schnittwertempfehlungen ab Seite 580
 Cutting data recommendations starting page 580

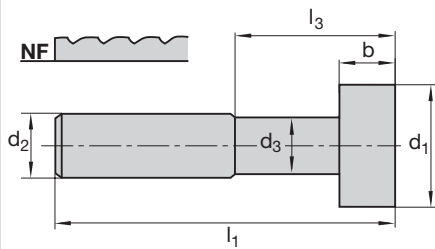

Katalog-Nr.	Cat.-No.	1605	1606	1607
Typ	Type	NF		
Norm	Standard	DIN 851 AA	DIN 851 AB	DIN 851 AD
Drallwinkel	Helix angle	≈ 25°		
Zylinderschaft	Straight shank	DIN 1835 A	DIN 1835 B	DIN 1835 D
Beschichtung	Coating	-		
Werkstoff	Material	HSS-E EMo5Co5		

d ₁ d ₁₁	b d ₁₁	für T-Nuten for T-Slots	l ₁	l ₃	d ₂ h 6	d ₃	z	Ident No.	Ident No.	Ident No.
16	8	8	62	22	10	7	6	1177418	1177604	1177917
18	8	10	70	25	12	8	6	1177427	1177613	1177926
19	9	10	71	26	12	8	6	1177436	1177622	1177935
21	9	12	74	29	12	10	6	1177445	1177631	1177944
22	10	12	75	30	12	10	6	1177454	1177640	1177953
25	11	14	82	34	16	12	6	1177463	1177659	1177962
28	12	16	85	37	16	13	6	1177472	1177668	1177971
32	14	18	90	42	16	15	6	1177481	1177677	1177980
36	16	20	103	47	25	17	8	1177490	1177679	1177999
40	18	22	108	52	25	19	8	1177506	1177681	1178006
45	20	24	113	57	25	21	8	1177515	1177683	1178015
50	22	28	124	64	32	25	8	1121600	1121599	1121598

Schnittwertempfehlungen ab Seite 580
Cutting data recommendations starting page 580

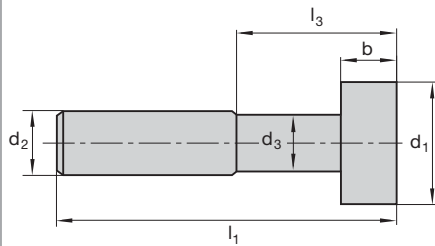

Katalog-Nr.	Cat.-No.	1641	1643
Typ	Type	N	
Norm	Standard	DIN 850 B	DIN 850 D/F
Drallwinkel	Helix angle	≈ 8° kreuzverzahnt staggered tooth	
Zylinderschaft	Straight shank	DIN 1835 A ¹⁾	DIN 1835 B/D
Beschichtung	Coating	-	
Werkstoff	Material	HSS-E EMo5Co5	

d ₁ h 12	b e 8	l ₁	l ₃	Für Scheibenfedern For Woodruff key	d ₂ h 6	z	Ident No.	Ident No.
4,5	1	50	14	1 x 1,4	6	6	1179817	1180128
7,5	1,5	50	14	1,5 x 2,6	6	6	1179826	1180137
7,5	2	50	14	2 x 2,6	6	6	1179835	1180146
10,5	2	50	14	2 x 3,7	6	6	1179844	1180155
10,5	3	50	14	3 x 3,7	6	6	1179862	1180173
13,5	3	56	16	3 x 5	10	8	1179880	1180182
13,5	4	56	16	4 x 5	10	8	1179899	1180191
16,5	3	56	16	3 x 6,5	10	8	1179906	1180208
16,5	4	56	16	4 x 6,5	10	8	1179915	1180217
16,5	5	56	16	5 x 6,5	10	8	1179924	1180226
19,5	4	63	23	4 x 7,5	10	8	1179942	1180235
19,5	5	63	23	5 x 7,5	10	8	1179951	1180244
19,5	6	63	23	6 x 7,5	10	8	1179960	1180253
22,5	5	63	23	5 x 9	10	10	1179988	1180262
22,5	6	63	23	6 x 9	10	10	1179997	1180271
22,5	8	63	23	8 x 9	10	10	1180002	1180280
25,5	6	63	23	6 x 10	10	10	1180020	1180299
28,5	6	63	23	6 x 11	10	10	1180039	1180306
28,5	8	63	23	8 x 11	10	10	1180048	1180315
28,5	10	71	26	10 x 11	12	10	1180057	1180324
32,5	8	71	26	8 x 13	12	10	1180075	1180333
32,5	10	71	26	10 x 13	12	10	1180084	1180342
45,5	10	71	26	10 x 16	12	12	1180119	1180351

¹⁾ Auf Wunsch auch mit Zylinderschaft DIN 1835 Form B (= Fläche) und D (= Gewinde)

¹⁾ On request also furnished with straight shank DIN 1835 form B (= Clamping flat) and D (= Drawbar thread)

Schnittwertempfehlungen ab Seite 580

Cutting data recommendations starting page 580

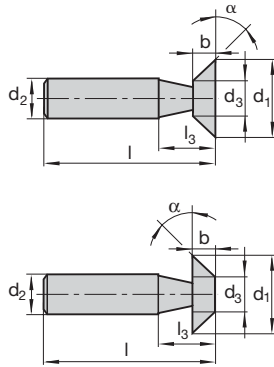

1661



1662



Katalog-Nr.	Cat.-No.	1661	1662					
Typ	Type	N						
Norm	Standard	DIN 1833 C/E	DIN 1833 D/F					
Zahnform	Tooth form	drallgenutet spiral fluted						
Schneidengeometrie	Cutting geometry	am Umfang schneidend und an der Stirnseite schneidend cutting on periphery and face						
Zylinderschaft	Straight shank	DIN 1835 B/D						
Beschichtung	Coating	-						
Werkstoff	Material	HSS-E EMO5Co5						
d ₁	d ₃	b	l	l ₃	d ₂ h 6	z	Ident No.	Ident No.
$\alpha = \text{Fräserwinkel } 45^\circ \quad \alpha = \text{Cutter angle } 45^\circ$								
16	8	4	60	15	6	8	1182000	1182509
20	10	5	63	18	6	10	1182019	1182518
25	12,4	6,3	67	22	6	10	1182028	1182527
32	16	8	71	23	8	12	1182037	1182536
40	20	10	80	32	8	8	1182046	1182545
$\alpha = \text{Fräserwinkel } 60^\circ \quad \alpha = \text{Cutter angle } 60^\circ$								
16	8,7	6,3	60	15	6	8	1182108	1182607
20	10,8	8	63	18	6	10	1182117	1182616
25	13,4	10	67	22	6	10	1182126	1182625
32	17,5	12,5	71	23	8	12	1182135	1182634
40	21,5	16	80	32	8	8	1182144	1182643

Schnittwertempfehlungen ab Seite 580
Cutting data recommendations starting page 580

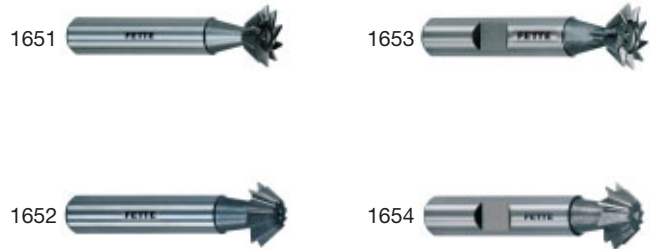
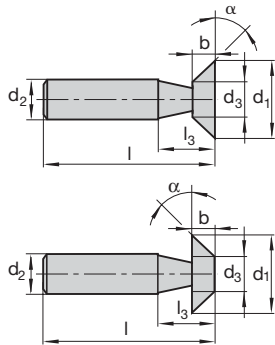

Katalog-Nr.	Cat.-No.	1651	1652	1653	1654					
Typ	Type	H								
Norm	Standard	DIN 1833 A	DIN 1833 B	DIN 1833 C	DIN 1833 D					
Zahnform	Tooth form	geradegenutet spiral fluted								
Schneidengeometrie	Cutting geometry	am Umfang schneidend cutting on periphery								
Zylinderschaft	Straight shank	und stirnseitig and face		und stirnseitig and face						
Beschichtung	Coating	DIN 1835 A		DIN 1835 B						
Werkstoff	Material	HSS-E EMo5Co5								
d ₁	d ₃	b	l	l ₃	d ₂ h 6	z	Ident No.	Ident No.	Ident No.	Ident No.
$\alpha = \text{Fräserwinkel } 45^\circ \quad \alpha = \text{Cutter angle } 45^\circ$										
16	8	4	60	15	12	8	1181813	1182215	1184188	1184268
20	10	5	63	18	12	10	1181822	1182224	1184197	1184277
25	12,4	6,3	67	22	12	10	1181831	1182233	1184204	1184286
32	16	8	71	23	16	12	1181939	1182304	1184213	1184295
$\alpha = \text{Fräserwinkel } 60^\circ \quad \alpha = \text{Cutter angle } 60^\circ$										
16	8,7	6,3	60	15	12	8	1181840	1182242	1184222	1184302
20	10,8	8	63	18	12	10	1181859	1182251	1184231	1184311
25	13,4	10	67	22	12	10	1181868	1182260	1184240	1184320
32	17,5	12,5	71	23	16	12	1181957	1182313	1184259	1184339
$\alpha = \text{Fräserwinkel } 70^\circ \quad \alpha = \text{Cutter angle } 70^\circ$										
16	10,9	7	60	15	12	8	1181877	1182279	1184269	1184349
20	13,4	9	63	18	12	10	1181886	1182288	1184271	1184351
25	17	11	67	22	12	10	1181895	1182297	1184273	1184353

Schnittwertempfehlungen ab Seite 580
Cutting data recommendations starting page 580

radial-axial hinterdreht
backed off radially and axially

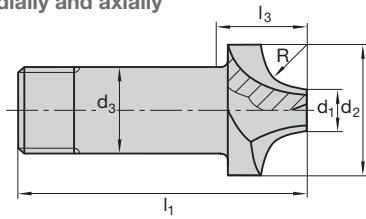

Katalog-Nr.	Cat.-No.	1664
Typ	Type	N
Norm	Standard	DIN 6518 B / D ¹⁾
Schneidenwinkel (axial)	Cutting angle (axial)	≈ 5°
Zylinderschaft	Straight shank	DIN 1835 B / D
Beschichtung	Coating	-
Werkstoff	Material	HSS-E EMo5Co5

Rh 11	d ₁ js 14	d ₂ H 6	d ₃	l ₁	l ₃	z	Ident No.
1	6	10	8	60	20	4	1183152
1,5	6	10	9	60	20	4	1183170
2	6	10	10	60	20	4	1183009
2,5	6	10	11	60	20	4	1183198
3	6	12	12	60	15	4	1183018
3,5	6	12	13	60	15	4	1183214
4	6	12	14	60	15	4	1183027
4,5	6	12	15	60	15	4	1183223
5	6	12	16	60	15	4	1183036
5,5	8	16	19	67	19	4	1183232
6	8	16	20	67	19	4	1183045
6,5	8	16	21	71	23	4	1183250
7	8	16	22	71	23	4	1183269
7,5	8	16	23	71	23	4	1183278
8	8	16	24	71	23	4	1183054
8,5	8	25	25	85	29	4	1183287
9	8	25	26	85	29	4	1183296
10	8	25	28	85	29	4	1183063
11	10	25	32	90	34	4	1183321
12	10	25	34	90	34	4	1183072
12,5	16	25	41	100	44	6	1183330
13	16	25	42	100	44	6	1183349
14	16	25	44	100	44	6	1183081
15	16	25	46	100	44	6	1183358
16	16	25	48	100	44	6	1183090
18	16	32	52	112	52	6	1183107
20	16	32	56	112	52	6	1183116

¹⁾ Kombischäft bis einschließlich Schaft-Ø 20, 25 und 32 liefern wir mit Zylinderschaft und Anzugsgewinde DIN 1835 D

¹⁾ Combination-shank from Ø 20, 25 and 32 included furnished as straight shank and draw bar thread DIN 1835 D

Schnittwertempfehlungen ab Seite 580
Cutting data recommendations starting page 580

mit Längsnut
with standard keyway

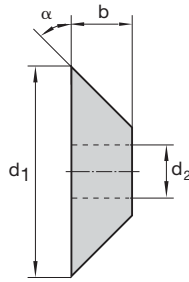

Katalog-Nr.	Cat.-No.	1302
Typ	Type	H
Norm	Standard	DIN 842 A
Drallwinkel	Helix angle	geradeverzahnt straight tooth
Werkstoff	Material	HSS-E EMo5Co5

d ₁ k 14	b js 14	d ₂ H 7	z	Ident No.
$\alpha = \text{Fräserwinkel } 45^\circ \quad \alpha = \text{Cutter angle } 45^\circ$				
50	13	13	18	1099823
63	18	16	20	1099832
80	22	22	22	1099841
100	28	27	26	1099850
125	36	32	28	1099869
$\alpha = \text{Fräserwinkel } 50^\circ \quad \alpha = \text{Cutter angle } 50^\circ$				
50	16	13	18	1099896
63	20	16	20	1099903
80	25	22	22	1099912
100	32	27	26	1099921
$\alpha = \text{Fräserwinkel } 55^\circ \quad \alpha = \text{Cutter angle } 55^\circ$				
50	16	13	16	1100312
63	20	16	18	1100321
80	25	22	20	1100330
100	32	27	22	1100349
125	40	32	24	1100358
$\alpha = \text{Fräserwinkel } 60^\circ \quad \alpha = \text{Cutter angle } 60^\circ$				
63	20	16	18	1099976
80	25	22	20	1099985
100	32	27	22	1099994
125	40	32	24	1100009

Schnittwertempfehlungen ab Seite 582
Cutting data recommendations starting page 582

mit Längsnut
with standard keyway

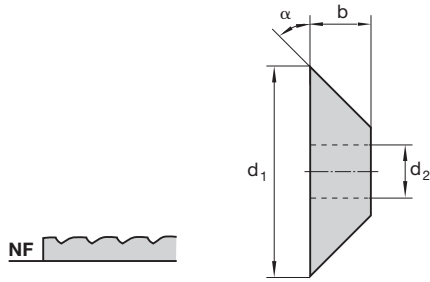

Katalog-Nr.	Cat.-No.	1305
Typ	Type	NF
Norm	Standard	≈ DIN 842 A
Drallwinkel	Helix angle	≈ 25° Rechtsdrall R.H. Spiral
Werkstoff	Material	HSS-E EMO5Co5

d ₁ k 14	b js 14	d ₂ H 7	z	Ident No.
$\alpha = \text{Fräserwinkel } 45^\circ \quad \alpha = \text{Cutter angle } 45^\circ$				
80	22	22	8	1100508
100	28	27	10	1100517
125	36	32	10	1100526
160	45	40	12	1100535
$\alpha = \text{Fräserwinkel } 50^\circ \quad \alpha = \text{Cutter angle } 50^\circ$				
80	25	22	8	1100544
100	32	27	10	1100553
125	40	32	10	1100562
$\alpha = \text{Fräserwinkel } 60^\circ \quad \alpha = \text{Cutter angle } 60^\circ$				
80	25	22	10	1100580
100	32	27	12	1100599
125	40	32	12	1100606
160	50	40	14	1100615

Schnittwertempfehlungen ab Seite 582
Cutting data recommendations starting page 582

Prismenfräser
Double Angle Milling Cutters, symmetrically

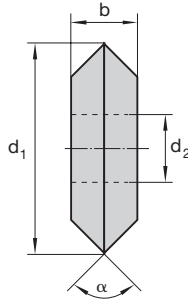

Katalog-Nr.	Cat.-No.	1322
Typ	Type	H
Norm	Standard	DIN 847 bzw. erweitert extended
Drallwinkel	Helix angle	-
Werkstoff	Material	HSS-E EMo5Co5

d ₁ k 14	b js 16	d ₂ H 7	z	Ident No.
$\alpha = \text{Fräserwinkel } 45^\circ \quad \alpha = \text{Cutter angle } 45^\circ$				
50	8	16	22	1103113
63	10	22	24	1103122
80	12	27	26	1103131
100	18	32	30	1103140
$\alpha = \text{Fräserwinkel } 60^\circ \quad \alpha = \text{Cutter angle } 60^\circ$				
50	10	16	20	1103159
63	14	22	22	1103168
80	18	27	24	1103177
100	25	32	28	1103186
$\alpha = \text{Fräserwinkel } 90^\circ \quad \alpha = \text{Cutter angle } 90^\circ$				
50	14	16	16	1103195
63	20	22	18	1103202
80	22	27	20	1103211
100	32	32	22	1103220
$\alpha = \text{Fräserwinkel } 120^\circ \quad \alpha = \text{Cutter angle } 120^\circ$				
63	20	22	16	1103248
80	25	27	20	1103257

Schnittwertempfehlungen ab Seite 582
 Cutting data recommendations starting page 582

hinterdreht
backed off

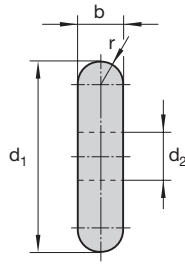

Katalog-Nr.	Cat.-No.	1371
Typ	Type	N
Norm	Standard	DIN 856 bzw. erweitert extended
Werkstoff	Material	HSS-E EMO5Co5

rh 11	d ₁ k 14	b	d ₂ H 7	z ⚙	Ident No.
0,5	50	1	16	16	1105816
0,75	50	1,5	16	16	1105825
1	50	2	16	14	1105834
1,25	50	2,5	16	14	1105843
1,5	50	3	16	14	1105852
1,6	50	3,2	16	14	1105861
1,75	50	3,5	16	14	1105870
2	50	4	16	14	1105889
2,25	63	4,5	22	12	1105898
2,5	63	5	22	12	1105905
2,75	63	5,5	22	12	1105914
3	63	6	22	12	1105923
3,25	63	6,5	22	12	1105932
3,5	63	7	22	12	1105941
4	63	8	22	12	1105969
4,25	63	8,5	22	12	1105978
4,5	63	9	22	12	1105987
5	63	10	22	12	1106003
5,25	80	10,5	27	12	1106012
5,5	80	11	27	12	1106021
6	80	12	27	12	1106030
6,5	80	13	27	12	1106049
7	80	14	27	12	1106058
7,5	80	15	27	12	1106067
8	80	16	27	12	1106076
9	100	18	32	12	1106094
10	100	20	32	12	1106110
11	100	22	32	12	1106129
12	100	24	32	12	1106138
12,5	100	25	32	12	1106147
14	125	28	32	12	1106165
15	125	30	32	12	1106174
16	125	32	32	12	1106183
18	125	36	32	12	1106209
20	125	40	32	12	1106227
25	145	50	40	12	1106254

Schnittwertempfehlungen ab Seite 582
 Cutting data recommendations starting page 582

hinterdreht
backed off

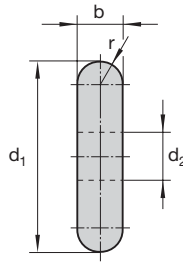

Katalog-Nr.	Cat.-No.				1372
Typ	Type				N
Norm	Standard				≈ DIN 856 d ₁ B ≙ DIN Standard
Besonderheiten	Special features				Extra große Fräserdurchmesser Special large cutter dia.
Werkstoff	Material				HSS-E EMo5Co5
rh 11	d ₁ k 14	b	d ₂ H 7	z	Ident No.
1,5	100	3	22	24	1106263
2	100	4	22	24	1106272
2,5	110	5	27	24	1106281
3	110	6	27	24	1106290
4	110	8	27	18	1106307
5	110	10	32	18	1106316
6	110	12	32	14	1106325
8	110	16	32	14	1106334

Schnittwertempfehlungen ab Seite 582
 Cutting data recommendations starting page 582

hinterdreht
backed off

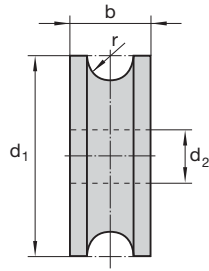

Katalog-Nr.	Cat.-No.	1381
Typ	Type	N
Norm	Standard	DIN 855
Werkstoff	Material	HSS-E EMo5Co5

rh 11	d ₁ k 14	b	d ₂ H 7	z 	Ident No.
1,5	50	8	16	14	1106744
2	50	9	16	14	1106771
2,5	63	10	22	12	1106799
3	63	12	22	12	1106815
3,5	63	16	22	12	1106833
4	63	16	22	12	1106851
4,5	63	18	22	12	1106879
5	63	20	22	12	1106897
6	80	24	27	12	1106922
7	80	32	27	12	1106940
7,5	80	32	27	12	1106959
8	80	32	27	12	1106968
9	100	36	32	12	1106986
10	100	36	32	12	1107002
11	100	40	32	12	1107011
12	100	40	32	12	1107020
12,5	100	40	32	12	1107039
14	125	48	32	10	1107057
15	125	50	32	10	1107066
16	125	50	32	10	1107075
20	125	60	32	10	1107119
25	145	80	40	10	1107146

Schnittwertempfehlungen ab Seite 582
Cutting data recommendations starting page 582

radial-axial
 hinterdreht

 backed off
 radially and axially

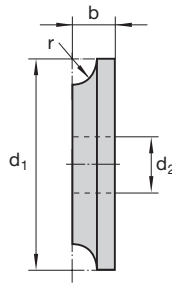

Katalog-Nr.	Cat.-No.	1391
Typ	Type	N
Norm	Standard	DIN 6513
Werkstoff	Material	HSS-E EMo5Co5

rh 11	d ₁ js 16	b	d ₂ H 7	z	Ident No.
2	50	5	16	14	1108038
2,5	63	5	22	12	1108047
3	63	6	22	12	1108056
4	63	8	22	12	1108074
5	63	10	22	12	1108083
6	80	12	27	12	1108092
8	80	16	27	12	1108118
10	100	18	32	12	1108136
12	100	20	32	12	1108154
14	125	24	32	10	1108172

Schnittwertempfehlungen ab Seite 582
 Cutting data recommendations starting page 582

für Steigungen nach Modul
mit versetzten Zähnen
und einem Meßzahn

for module pitch
with offset teeth and
one tooth for checking

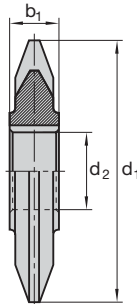

Katalog-Nr.	Cat.-No.	2500
Eingriffswinkel	Pressure angle	20°
Bezugsprofil	Basic profile	I nach to DIN 3972
Drallwinkel	Helix angle	geradeverzahnt straight tooth
Ausführung	Type	gefräst, mit Fasenschliff milled, with eccentric relief
Werkstoff	Material	HSS DMo5

m	d ₁	b ₁	d ₂	Ident No.
1	70	8	22	1234419
1,5	70	8	22	1234437
2	70	8	22	1234455
2,5	70	8	22	1234473
3	80	10	22	1234491
3,5	80	10	22	1234516
3,75	80	12	22	-
4,5	80	13	22	1234543
5,5	100	15	27	-
6,5	100	18	27	-
8	100	22	27	1234605
10	125	27	32	1234623

Wir fertigen außerdem: Schneckenfräser mit größeren Abmessungen und mit anderen Bezugsprofilen, auch als Trapezgewindefräser mit Steigung in Millimetern
We also manufacture: worm cutters of larger dimensions with different basic profiles, also available as trapezoidal thread milling cutters with millimetre pitch

Schnittwertempfehlungen ab Seite 582
Cutting data recommendations starting page 582

für Steigungen nach Modul
mit einem Meßzahn

for module pitch
with one tooth for checking

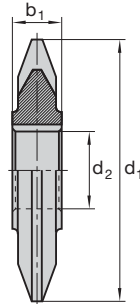

Katalog-Nr.	Cat.-No.	2512
Eingriffswinkel	Pressure angle	20°
Bezugsprofil	Basic profile	I nach to DIN 3972
Drallwinkel	Helix angle	kreuzverzahnt staggered tooth
Ausführung	Type	gefräst, mit Fasenschliff milled, with eccentric relief
Werkstoff	Material	HSS-E EMo5Co5

m	d ₁	b ₁	d ₂	Ident No.
1	140	8	40	1235212
1,5	140	8	40	1235221
2	140	10	40	1235230
2,5	140	10	40	1235249
3	140	10	40	1235258
3,5	140	12	40	1235267
4	140	12	40	1235276
4,5	140	14	40	1235285
5	140	14	40	1235294
6	145	16	40	1235301
7	145	19	40	1235310
8	145	22	40	1235329
9	150	25	40	1235338
10	150	27	40	1235347

Wir fertigen außerdem: Zahnstangenfräser mit größeren Abmessungen,
anderen Bezugsprofilen und mit 10° geneigtem Profil
We also manufacture: rack cutters with larger dimensions, different basic
profiles and with 10° inclined profile

Schnittwertempfehlungen ab Seite 582
Cutting data recommendations starting page 582

zum Vorfräsen von Zahnrädern,
Zahnstangen und Schnecken
nach Modul
ohne Meßzahn
versetzte Spanbrecher ab Modul 10

for roughing gears, tooth racks
and worms of module pitch
without tooth for checking
staggered chip breakers from module 10

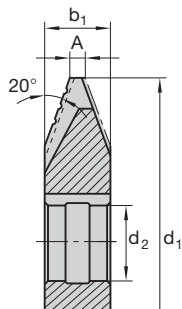



Katalog-Nr.	Cat.-No.	2513
Eingriffswinkel	Pressure angle	20°
Bezugsprofil	Basic profile	IV nach to DIN 3972
Drallwinkel	Helix angle	kreuzverzahnt staggered tooth
Ausführung	Type	gefräst, mit Fasenschliff milled, with eccentric relief
Werkstoff	Material	HSS-E EMo5Co5

m	d ₁	b ₁	d ₂	A	Ident No.
5	140	13	40	2,56	Auf Anfrage Upon request
5,5	140	14	40	2,86	
6	145	15	40	3,17	
6,5	145	17	40	3,48	
7	145	18	40	3,79	
7,5	145	19	40	4,1	
8	145	20	40	4,41	
9	150	23	40	5,04	
10	150	25	40	5,67	
11	150	28	40	6,3	
12	150	30	40	6,93	
13	155	34	40	7,56	
14	160	36	40	8,2	
15	165	38	40	8,83	
16	170	40	40	9,47	
17	180	43	50	10,11	
18	190	46	50	10,75	
19	195	48	50	11,39	
20	200	50	50	12,03	

Die in der Tabelle angegebene Zahnkopfbreite A kann dabei als Prüfmaß verwendet werden
The tooth tip width A given in the table can be used as a checking dimension

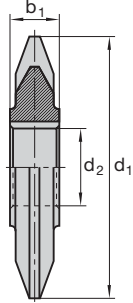
Schnittwertempfehlungen ab Seite 582
Cutting data recommendations starting page 582

<p>Steigungen nach Modul Form A: mit geradem Profil Form B: mit 10° geneigtem Profil¹⁾</p> <p>Module pitch Form A: with straight profile Form B: with 10° inclined profile¹⁾</p>					
Katalog-Nr.	Cat.-No.	2521¹⁾			
Eingriffswinkel	Pressure angle	20°			
Bezugsprofil	Basic profile	I nach DIN 3972			
Drallwinkel	Helix angle	geradeverzahnt straight tooth			
Ausführung	Type	hinterdreht backed off			
Werkstoff	Material	HSS-E EMo5Co5			
m	d₁	b₁	d₂	Ident No. Form A	Ident No. Form B
1	140	8	40	1235711	1235855
1,5	140	8	40	1235720	1235864
2	140	8	40	1235739	1235873
2,5	140	10	40	1235748	1235882
3	140	10	40	1235757	1235891
3,5	140	10	40	1235766	1235908
4	140	10	40	1235775	1235917
4,5	140	11	40	1235784	1235926
5	140	13	40	1235793	1235935
6	145	15	40	1235800	1235944
7	145	17	40	1235819	1235953
8	145	20	40	1235828	1235962
9	150	22	40	1235837	1235971
10	150	25	40	1235846	1235980

¹⁾ Nur lieferbar, solange Vorrat

¹⁾ Available until stock is depleted

Falls nicht anders vorgeschrieben, liefern wir Form A

Unless otherwise specified, we supply form A

Wir fertigen außerdem: Zahnstangenfräser mit größeren Abmessungen und anderen Bezugsprofilen

We also manufacture: rack cutters with larger dimensions and different basic profiles

Schnittwertempfehlungen ab Seite 582

Cutting data recommendations starting page 582

Steigungen nach Modul
Form A: mit geradem Profil
Form B: mit 10° geneigtem Profil¹⁾

Module pitch
Form A:
with straight profile
Form B:
with 10° inclined profile¹⁾

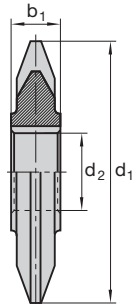
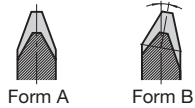

Katalog-Nr.	Cat.-No.	2522 ¹⁾
Eingriffswinkel	Pressure angle	20°
Bezugsprofil	Basic profile	I nach to DIN 3972
Drallwinkel	Helix angle	geradeverzahnt straight tooth
Ausführung	Type	hinterschliffen relief ground
Werkstoff	Material	HSS-E EM05Co5

m	d ₁	b ₁	d ₂	Ident No. Form A	Ident No. Form B
1	140	8	40	1236319	2125816
1,5	140	8	40	1236328	2254679
2	140	8	40	1236337	1236471
2,5	140	10	40	1236346	1236480
3	140	10	40	1236355	1236499
3,5	140	10	40	1236364	1236505
4	140	10	40	1236373	1236514
4,5	140	11	40	1236382	2222348
5	140	13	40	1236391	1236532
6	145	15	40	1236408	1236541
7	145	17	40	1236417	1236550
8	145	20	40	1236426	1236569
9	150	22	40	2120452	1236578
10	150	25	40	1236444	1236587

¹⁾ Nur lieferbar, solange Vorrat

¹⁾ Available until stock is depleted

Falls nicht anders vorgeschrieben, liefern wir Form A

Unless otherwise specified, we supply form A

Wir fertigen außerdem: Zahnstangenfräser mit größeren Abmessungen und anderen Bezugsprofilen

We also manufacture: rack cutters with larger dimensions and different basic profiles

Schnittwertempfehlungen ab Seite 582

Cutting data recommendations starting page 582

für Stirnräder nach Modul
for spur gears to module pitch

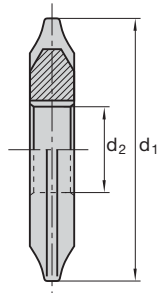

Katalog-Nr.	Cat.-No.	2601
Eingriffswinkel	Pressure angle	20°
Bezugsprofil	Basic profile	I nach to DIN 3972
Drallwinkel	Helix angle	-
Ausführung	Type	hinterdreht backed off
Werkstoff	Material	HSS-E EMo5Co5

m	d ₁	d ₂	Ident No.
0,3	35	13	Auf Anfrage Upon request
0,4	35	13	
0,5	40	16	
0,6	40	16	
0,7	40	16	
0,75	40	16	
0,8	40	16	
0,9	50	16	
1	50	16	
1,25	50	16	
1,5	60	22	
1,75	60	22	
2	60	22	
2,25	60	22	
2,5	65	22	
2,75	70	27	
3	70	27	
3,25	75	27	
3,5	75	27	
3,75	80	27	
4	80	27	
4,25	85	27	
4,5	85	27	
4,75	90	27	
5	90	32	
5,5	95	23	
6	100	32	
6,5	105	32	
7	105	32	
7,5	110	32	

Auf Wunsch werden auch Zahnformfräser über Modul 10 in Sätzen zu 8 Stück geliefert
If required, we also supply involute gear cutters above module 10 in sets of 8 units
Außerdem fertigen wir: Zahnformfräser mit anderen Eingriffswinkeln oder nach CP.
Zahnformfräser zum Fräsen von Stirnrädern mit weniger als 12 Zähnen
We also manufacture: Involute gear cutters with other pressure angels or to CP.
Involute gear cutters for cutting spur gears with less than 12 teeth

Schnittwertempfehlungen ab Seite 582
Cutting data recommendations starting page 582

für Stirnräder nach Modul
for spur gears to module pitch

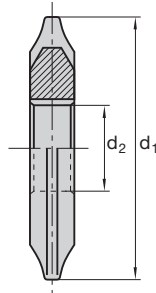

Katalog-Nr.	Cat.-No.	2601
Eingriffswinkel	Pressure angle	20°
Bezugsprofil	Basic profile	I nach to DIN 3972
Drallwinkel	Helix angle	-
Ausführung	Type	hinterdreht backed off
Werkstoff	Material	HSS-E EMO5Co5

m	d ₁	d ₂	Ident No.
8	110	32	Auf Anfrage Upon request
8,5	115	32	
9	115	32	
9,5	120	32	
10	120	32	
11	135	40	
12	145	40	
13	155	40	
14	160	40	
15	165	40	
16	170	40	
17	180	50	
18	190	50	
19	195	50	
20	205	50	

Satzenteilung von Modul 0,3 bis Modul 10 in Sätzen zu 8 Stück Specification of sets from module 0.3 to module 10 in sets of 8 units	
Fräser Cutter No.	für Zähnezahl for Number of teeth
1	12 - 13
2	14 - 16
3	17 - 20
4	21 - 25
5	26 - 34
6	35 - 54
7	55 - 134
8	135 - ∞

Satzenteilung von Modul 11 bis Modul 20 in Sätzen zu 15 Stück Specification of sets from module 11 to module 20 in sets of 15 units	
Fräser Cutter No.	für Zähnezahl for Number of teeth
1	12
1 1/2	13
2	14
2 1/2	15 - 16
3	17 - 18
3 1/2	19 - 20
4	21 - 22
4 1/2	23 - 25
5	26 - 29
5 1/2	30 - 34
6	35 - 41
6 1/2	42 - 54
7	55 - 79
7 1/2	80 - 134
8	135 - ∞

Auf Wunsch werden auch Zahnformfräser über Modul 10 in Sätzen zu 8 Stück geliefert
If required, we also supply involute gear cutters above module 10 in sets of 8 units
Außerdem fertigen wir: Zahnformfräser mit anderen Eingriffswinkeln oder nach CP.
Zahnformfräser zum Fräsen von Stirnrädern mit weniger als 12 Zähnen
We also manufacture: Involute gear cutters with other pressure angels or to CP.
Involute gear cutters for cutting spur gears with less than 12 teeth

Schnittwertempfehlungen ab Seite 582
Cutting data recommendations starting page 582

**für Zahnräder und Zahnstangen
 mit Innengewinde und Zentrierung
 zum Aufschrauben.
 2 Schlüsselflächen**

**for gears and racks
 with female thread and centring
 for screw-on.
 2 spanner flats**

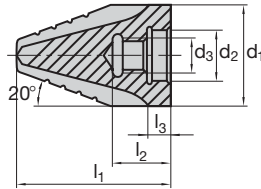

Katalog-Nr.	Cat.-No.	2620
Eingriffswinkel	Pressure angle	20°
Bezugsprofil	Basic profile	IV nach to DIN 3972
Drallwinkel	Helix angle	-
Ausführung	Type	gefräst und geschliffen milled and ground
Werkstoff	Material	HSS-E EMo5Co5

Fräser-Baumaße Overall Cutter			d ₃ (Zoll)	Aufnahme-Maße Adaptor dimensions			Ident No. Auf Anfrage Upon request
m	d ₁	l ₁		d ₂	l ₂	l ₃	
20	60	120	1 1/4	36	45	10	
22	65	125	1 1/4	36	45	10	
24	65	125	1 1/4	36	45	10	
26	70	130	1 1/4	36	45	10	
28	75	135	1 1/2	42	45	10	
30	80	135	1 1/2	42	45	10	
32	85	140	1 1/2	42	45	10	
34	90	145	1 1/2	42	45	10	
36	95	145	2	56	50	12	
38	100	150	2	56	50	12	
40	105	155	2	56	50	12	
42	110	155	2	56	50	12	
44	115	155	2	56	50	12	
46	120	160	2 1/2	70	50	12	
48	125	160	2 1/2	70	50	12	
50	130	160	2 1/2	70	50	12	

Anschlußmaße für Aufnahmedorne Mounting dimensions for adaptor mandrels					
d ₃ (Zoll)		d ₂	d ₁	l ₁	l ₂
BSW 1 1/4 - 7	Gg	36	70	40	9,5
BSW 1 1/2 - 6	Gg	42	90	40	9,5
BSW 2 - 4 1/2	Gg	56	115	45	11,5
BSW 2 1/2 - 4	Gg	70	130	45	11,5

**Aufnahmekegel wahlweise
Adaptor tapers optionally**

Morsekegel Morse taper shank	DIN 1806 DIN 1806
Morsekegel Morse taper shank	DIN 2207 DIN 2207
Metrische Kegel Metric taper	DIN 1806 DIN 1806
Steilkegel Steep taper	DIN 2080 DIN 2080

Diese Fräserausführung wird auch als Fertigfräser für Zahnstangen mit Bezugsprofil I oder II nach DIN 3972 geliefert
 This cutter version is also supplied as a finishing cutter for racks with basic profile I or II to DIN 3972

Schnittwertempfehlungen ab Seite 582
 Cutting data recommendations starting page 582

**Evolventenprofil mit Innen-
gewinde und Zentrierbohrung
zum Aufschrauben.
2 Schlüsselflächen**

Involute profile with female
thread and centring for screw-on.
2 spanner flats

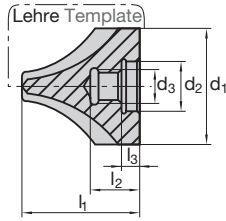

Katalog-Nr.	Cat.-No.	2621
Eingriffswinkel	Pressure angle	20°
Bezugsprofil	Basic profile	I oder/or II nach/to DIN 3972
Drallwinkel	Helix angle	-
Ausführung	Type	hinterdreht mit Profildfasenschliff backed off with ground profile lang
Werkstoff	Material	HSS-E EMo5Co5

m	Zähnezahl-Bereich Number of teeth range								Aufnahme-Maße Adaptor dimensions				Ident No.
	12 ... 16		17 ... 25		26 ... 54		55 ... D		d ₃ (Zoll)	d ₂	l ₂	l ₃	
20	70	115	66	115	62	120	60	120	1 1/4	36	45	10	Auf Anfrage Upon request
22	76	115	72	120	66	125	62	125	1 1/4	36	45	10	
24	84	120	78	120	74	125	68	125	1 1/4	36	45	10	
26	90	120	84	120	78	125	72	130	1 1/4	36	45	10	
28	98	120	90	120	84	125	78	135	1 1/2	42	45	10	
30	104	120	98	125	90	125	82	135	1 1/2	42	45	10	
32	110	125	104	125	96	130	88	145	1 1/2	42	45	10	
34	118	125	110	125	102	130	94	145	1 1/2	42	45	10	
36	124	130	116	130	108	135	98	145	2	56	50	12	
38	130	135	122	135	114	140	104	150	2	56	50	12	
40	136	135	128	140	120	145	110	155	2	56	50	12	
42	144	140	134	145	126	150	116	155	2	56	50	12	
44	150	150	140	155	130	155	120	155	2	56	50	12	
46	156	150	146	155	136	160	125	160	2 1/2	70	50	12	
48	164	160	152	155	142	160	130	160	2 1/2	70	50	12	
50	170	160	160	160	148	160	135	160	2 1/2	70	50	12	

Zahnform-Fingerfräser mit Evolventenprofil sind in der Regel nicht für Zähnezahlbereiche ausgelegt, sondern für spezielle Verzahnungsaufgaben mit bestimmter Zähnezahl. Bei Bestellung bitten wir daher um Werkstückbezeichnungen oder genaue Zahnradaten.
End mill type gear cutters with involute profiles are generally not designed for a number of teeth range but for special gear operations with a specific number of teeth. When ordering, therefore, please provide workpiece drawings or precise gear data.

Schnittwertempfehlungen ab Seite 582
Cutting data recommendations starting page 582

**stufenförmig,
wechselseitig schneidend
mit Längsnut**

**stepped-up type,
alternate cutting
with keyway**

Bezugsprofil IV DIN 3972
Basic profile IV DIN 3972

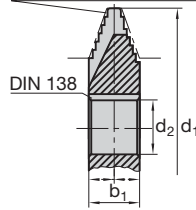

Radial-Span $\leq 8^\circ$
Radial rake $\leq 8^\circ$



Katalog-Nr.	Cat.-No.	2630
Eingriffswinkel	Pressure angle	20°
Bezugsprofil	Basic profile	IV nach to DIN 3972
Drallwinkel	Helix angle	-
Ausführung	Type	hinterdreht backed off
Werkstoff	Material	HSS-E EMo5Co5

m	d ₁	b ₁	d ₂	z	Ident No.
Fräser Reihe I Series I cutter					
12	145	28	40	16	2122085
14	160	32	40	16	2129266
16	170	37	40	16	2125036
18	180	42	50	16	2125037
20	200	46	50	16	2125005
22	210	50	50	16	2125006
24	220	54	50	16	2125007
26	240	58	60	16	2129268
28	250	63	60	16	2121680
30	260	68	60	16	2129276
Fräser Reihe II Series II cutter					
12	160	28	50	18	2125874
14	175	32	50	18	2129267
16	190	37	50	18	2121701
18	210	42	60	18	2126898
20	225	46	60	18	2122883
22	240	50	60	18	2127500
24	250	54	60	18	2127501
26	275	58	80	18	2129269
28	290	63	80	18	2129275
30	300	68	80	18	2129277

Schnittwertempfehlungen ab Seite 582
Cutting data recommendations starting page 582

für Kettenräder entspr.
Rollen- und Hülsenketten
nach DIN 8187, 8188.

for sprockets for
roller- and barrel chains
to DIN 8187, 8188.

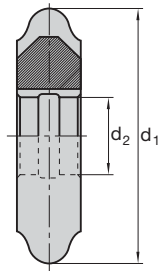

Katalog-Nr.	Cat.-No.		2701		
Ausführung	Type		hinterdreht backed off		
Werkstoff	Material		HSS-E EMO5Co5		
Teilung Pitch		Rollen-/Hülsen-Ø Roller/barrel Ø		d ₁	d ₂
mm	ca. Zoll	mm	ca. Zoll	mm	mm
6	15/64	4	5/32	63	22
6,35	1/4	3,3	5/32	63	22
8	5/16	5	3/16	63	22
9,525	3/8	5	3/16	70	22
9,525	3/8	6	15/64	70	22
9,525	3/8	6,35	1/4	70	22
12,7	1/2	7,75	5/16	70	22
12,7	1/2	7,93	5/16	70	22
12,7	1/2	8,51	5/16	70	22
15,875	5/8	10,16	5/16	90	27
19,05	3/4	11,9	15/32	90	27
19,05	3/4	12,07	1/2	90	27
25,4	1	15,88	5/8	100	27
30	1 1/4	15,88	5/8	105	32
31,75	1 1/4	19,05	3/4	110	32
38,1	1 1/2	22,22	7/8	125	32
38,1	1 1/2	25,4	1	125	32
44,45	1 3/4	25,4	1	140	40
44,45	1 3/4	27,94	1	140	40
50,8	2	28,57	1 1/8	140	40
50,8	2	29,21	1 1/8	140	40
57,15	2 1/4	35,71	1 13/32	150	40
63,5	2 1/2	39,37	1 13/32	170	50
63,5	2 1/2	39,68	1 9/16	170	50
76,2	3	47,62	1 7/8	190	50
76,2	3	48,26	1 7/8	190	50
Ident No. Auf Anfrage Upon request					

Satzenteilung in Sätzen zu 5 Stück	
Specification of sets of 5 units	
Fräser Cutter No.	für Zähneanzahl for Number of teeth
1	8 - 9
2	10 - 13
3	14 - 20
4	21 - 34
5	35 - ∞

Formfräser für Kettenräder werden sowohl in vollständigen Sätzen als auch einzeln geliefert. Bei der Bestellung von Einzelfräsern ist die Fräsernummer oder die zu fräsende Zähneanzahl anzugeben.

Form milling cutters for sprockets are supplied both in complete sets and separate. When ordering single cutters, please specify the cutter number or the number of teeth to be cut.

Außerdem fertigen wir: Formfräser für Kettenräder mit anderen oder größeren Abmessungen, oder mit eingesetzten Messern, für Kettenräder zu Gallketten DIN 8150 und 8151, Buchsenketten DIN 8164, SAE-Ketten, Renold-Ketten und für Kettenräder anderer Systeme.

We also manufacture: Form milling cutters for sprockets with other or larger dimensions or with inserted blades, for sprockets to match Gall's chains to DIN 8150 and 8151, barrel chains to DIN 8164, SAE chains, Renold chains and for sprockets of other systems.

Schnittwertempfehlungen ab Seite 582
Cutting data recommendations starting page 582

**für Zahnriemenscheiben
halb-überschneidend
for timing belt pulleys
semi-topping**

- r_k = Außenradius ext. radius
- b = Lückenbreite gap width
- α = Lückenwinkel gap angle
- h = Frästiefe depth of cut
- h_1 = Zahnhöhe am Fräser height of tooth on cutter
- r_1 = Zahnkopfradius tooth tip radius
- r_2 = Zahngrundradius tooth root radius

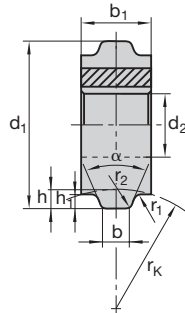

Katalog-Nr.	Cat.-No.	2742
Eingriffswinkel	Pressure angle	-
Bezugsprofil	Basic profile	-
Drallwinkel	Helix angle	-
Ausführung	Type	hinterdreht backed off
Werkstoff	Material	HSS-E EMo5Co5

T	z	Fräsermaße Cutter dimensions			Ident No.
		d ₁	b ₁	d ₂	
T 2,5 SE	bis/to 20	63	5	22	Auf Anfrage Upon request
T 2,5 N	über/over 20	63	5	22	
T 5 SE	bis/to 20	63	6	22	
T 5 N	über/over 20	63	6	22	
T 10 SE	bis/to 20	63	9	22	
T 10 N	über/over 20	63	9	22	
T 20 SE	bis/to 20	70	18	27	
T 20 N	über/over 20	70	18	27	

T	Kurzzeichen Short sign	Fräsermaße Cutter dimensions			Ident No.
		d ₁	b ₁	d ₂	
5,080 = 1/5"	XL	63	5	22	Auf Anfrage Upon request
9,525 = 3/8"	L	63	8	22	
12,70 = 1/2"	H	63	10	22	
22,25 = 7/8"	XH	80	18	32	
31,75 = 1 1/4"	XXH	90	26	32	

Satzenteilung für metrische Teilungen nach DIN 7721 Specification for metric pitches to DIN 7721	
Fräser Cutter No.	für Zähneanzahl for Number of teeth
1	10 - 13
2	14 - 20
3	21 - 34
4	35 - 71
5	72 - ∞

Satzenteilung für Zoll-Teilungen nach DIN ISO 5294 Specification for inch pitches to DIN ISO 5294	
Fräser Cutter No.	für Zähneanzahl for Number of teeth
1	10 - 13
2	14 - 20
3	21 - 34
4	35 - 71
5	72 - ∞

Die Profilhöhe h_1 am Fräser ist damit abhängig von der zu fräsenden Radzähnezahl. Diese ist zur technischen Bearbeitung mit anzugeben.
 The profile height h_1 on the cutter therefore depends on the number of teeth to be cut. This number must also be quoted to facilitate order processing.
 Beim Fräsen von Zahnriemenscheiben im Einzelteilverfahren wird der Zahnkopfradius r_1 überschritten.
 When cutting timing belt pulleys using the single indexing method, the tooth tip radius r_1 is also semi-topped.
 Für Räder mit abweichender Riementeilung oder mit Sonderprofilen benötigen wir Maßangaben entsprechend obenstehender Abbildung.
 For gears with different belt pitches or with special profiles we require dimensional data as shown in the figure above.

Schnittwertempfehlungen ab Seite 582
 Cutting data recommendations starting page 582

für Keilwellenprofile
for spline shaft profiles

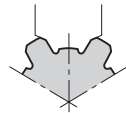

Form D (Standard)
mit Höcker with clearance lugs
mit Kantenbruch with chamfer

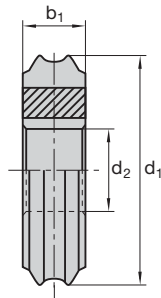

Katalog-Nr.	Cat.-No.	2730
Ausführung	Type	hinterdreht oder hinterschliffen backed off or relief ground
Werkstoff	Material	HSS-E EMO5Co5

Keilwellenmaße Spline shaft dimensions		Fräsermaße Cutter dimensions			Ident No.
DIN ISO 14 – leichte Reihe DIN ISO 14 – light series Nennmaß ¹⁾ Nominal dim. ¹⁾	Anzahl der Keile Number of Splines	d ₁	b ₁	d ₂	
23 x 26 x 6	6	63	10	22	Auf Anfrage Upon request
26 x 30 x 6	6	63	12	22	
28 x 32 x 6	6	63	13	22	
32 x 36 x 6	8	63	11	22	
36 x 40 x 7	8	63	12	22	
42 x 46 x 8	8	63	13	22	
46 x 50 x 9	8	70	14	27	
52 x 58 x 10	8	70	16	27	
56 x 62 x 10	8	70	18	27	
62 x 68 x 12	8	70	18	27	
72 x 78 x 12	10	70	16	27	
82 x 88 x 12	10	80	19	32	
92 x 98 x 14	10	80	20	32	
102 x 108 x 16	10	80	21	32	
112 x 120 x 18	10	80	23	32	
DIN ISO 14 – mittlere Reihe DIN ISO 14 – medium series Nennmaß ¹⁾ Nominal dim. ¹⁾	Anzahl der Keile Number of Splines	d ₁	b ₁	d ₂	Ident No.
11 x 14 x 3	6	56	6	22	Auf Anfrage Upon request
13 x 16 x 3,5	6	56	6	22	
16 x 20 x 4	6	56	8	22	
18 x 22 x 5	6	56	8	22	
21 x 25 x 5	6	63	9	22	
23 x 28 x 6	6	63	10	22	
26 x 32 x 6	6	63	12	22	
28 x 43 x 7	6	63	13	22	
32 x 38 x 6	8	63	11	22	
36 x 42 x 7	8	63	12	22	
42 x 48 x 8	8	63	13	22	
46 x 54 x 9	8	70	14	27	
52 x 60 x 10	8	70	16	27	
56 x 65 x 10	8	70	18	27	
62 x 72 x 12	8	70	18	27	
72 x 82 x 12	10	70	16	27	

¹⁾ Nennmaß: Innen-Durchmesser x Außen-Durchmesser x Keilbreite

¹⁾ Nominal dimension: inside dia. x outside dia. x spline width

Falls nicht anders vorgeschrieben, liefern wir Form D in hinterdrehter Ausführung
Unless otherwise specified, we supply form D in the relief turned version

Schnittwertempfehlungen ab Seite 582

Cutting data recommendations starting page 582



**für Keilwellenprofile
for spline shaft profiles**

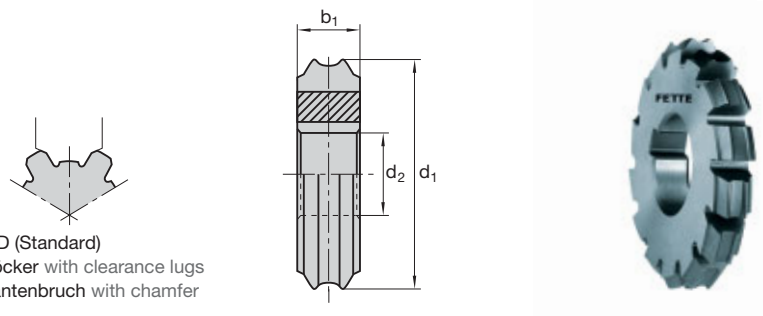

Form D (Standard)
mit Höcker with clearance lugs
mit Kantenbruch with chamfer

Katalog-Nr.	Cat.-No.	2730
Ausführung	Type	hinterdreht oder hinterschliffen backed off or relief ground
Werkstoff	Material	HSS-E EMo5Co5

Keilwellenmaße Spline shaft dimensions		Fräsermaße Cutter dimensions			Ident No.
DIN ISO 14 – leichte Reihe DIN ISO 14 – light series Nennmaß ¹⁾ Nominal dim. ¹⁾	Anzahl der Keile Number of Splines	d ₁	b ₁	d ₂	
82 x 92 x 12	10	70	19	32	Auf Anfrage Upon request
92 x 102 x 14	10	70	20	32	
102 x 112 x 16	10	70	21	32	
112 x 125 x 18	10	70	23	32	
DIN 5464 DIN 5464 Nennmaß ¹⁾ Nominal dim. ¹⁾	Anzahl der Keile Number of Splines	d ₁	b ₁	d ₂	Ident No.
16 x 20 x 2,5	10	56	5	22	Auf Anfrage Upon request
18 x 23 x 3	10	56	5	22	
21 x 26 x 3	10	56	7	22	
23 x 29 x 4	10	63	7	22	
26 x 32 x 4	10	63	8	22	
28 x 35 x 4	10	63	8	22	
32 x 40 x 5	10	70	10	27	
36 x 45 x 5	10	70	12	27	
42 x 52 x 6	10	70	13	27	
46 x 56 x 7	10	70	13	27	
52 x 60 x 5	16	80	9	32	
56 x 72 x 6	16	80	10	32	
62 x 72 x 6	16	80	11	32	
72 x 82 x 7	16	80	11	32	
82 x 92 x 6	20	90	11	32	
92 x 102 x 7	20	90	12	32	
102 x 115 x 8	20	90	13	32	
112 x 125 x 9	20	90	13	32	

¹⁾ Nennmaß: Innen-Durchmesser x Außen-Durchmesser x Keilbreite
¹⁾ Nominal dimension: inside dia. x outside dia. x spline width
 Falls nicht anders vorgeschrieben, liefern wir Form D in hinterdrehter Ausführung
 Unless otherwise specified, we supply form D in the relief turned version

Schnittwertempfehlungen ab Seite 582
 Cutting data recommendations starting page 582



für Keilwellenprofile
for spline shaft profiles

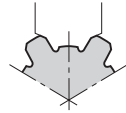

Form D (Standard)
mit Höcker with clearance lugs
mit Kantenbruch with chamfer

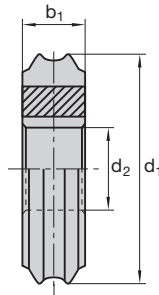

Katalog-Nr.	Cat.-No.	2730
Ausführung	Type	hinterdreht oder hinterschleifen backed off or relief ground
Werkstoff	Material	HSS-E EMo5Co5

Keilwellenmaße Spline shaft dimensions		Fräsermaße Cutter dimensions			Ident No.
DIN 5471 – 4 Keile					
DIN 5471 – 4 Splines					
Nennmaß¹⁾	Nominal dim.¹⁾	d₁	b₁	d₂	
11 x 15	x 3	56	11	22	
13 x 17	x 4	56	12	22	
16 x 20	x 6	56	12	22	
18 x 22	x 6	63	14	22	
21 x 25	x 8	63	14	22	
24 x 28	x 8	63	16	22	
28 x 32	x 10	63	17	22	
32 x 38	x 10	70	22	27	
36 x 42	x 10	70	23	27	
42 x 48	x 12	70	27	27	
46 x 52	x 14	70	28	27	
52 x 60	x 14	80	34	32	
58 x 65	x 16	80	38	32	
62 x 70	x 16	80	40	32	
68 x 78	x 16	80	45	32	
DIN 5472 – 6 Keile					Auf Anfrage Upon request
DIN 5472 – 6 Splines					
Nennmaß¹⁾	Nominal dim.¹⁾	d₁	b₁	d₂	
21 x 25	x 5	63	9	22	
23 x 28	x 6	63	10	22	
26 x 32	x 6	63	12	22	
28 x 34	x 7	63	13	22	
32 x 38	x 8	70	14	27	
36 x 42	x 8	70	16	27	
42 x 48	x 10	70	17	27	
46 x 52	x 12	80	18	32	
52 x 60	x 14	80	20	32	
58 x 65	x 14	80	22	32	
62 x 70	x 16	80	23	32	
68 x 78	x 16	90	27	32	
72 x 82	x 16	90	29	32	
78 x 90	x 16	90	33	32	
82 x 95	x 16	90	36	32	
88 x 100	x 16	90	36	32	

¹⁾ Nennmaß: Innen-Durchmesser x Außen-Durchmesser x Keilbreite

¹⁾ Nominal dimension: inside dia. x outside dia. x spline width

Falls nicht anders vorgeschrieben, liefern wir Form D in hinterdrehter Ausführung
Unless otherwise specified, we supply form D in the relief turned version

Schnittwertempfehlungen ab Seite 582

Cutting data recommendations starting page 582



**für Keilwellenprofile
for spline shaft profiles**

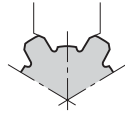

Form D (Standard)
mit Höcker with clearance lugs
mit Kantenbruch with chamfer

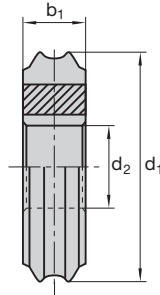

Katalog-Nr.	Cat.-No.	2730
Ausführung	Type	hinterdreht oder hinterschliffen backed off or relief ground
Werkstoff	Material	HSS-E EMo5Co5

Keilwellenmaße Spline shaft dimensions	Fräsermaße Cutter dimensions			Ident No.
DIN 5472 - 6 Keile DIN 5472 - 6 Splines				
Nennmaß¹⁾ Nominal dim.¹⁾	d₁	b₁	d₂	
92 x 105 x 20	90	38	32	
98 x 110 x 20	90	40	32	
105 x 120 x 20	100	45	32	
115 x 130 x 20	100	45	32	
130 x 145 x 24	100	54	32	
Zapfwelle²⁾ P.t.o. shaft²⁾	Fräsermaße Cutter dimensions			Ident No.
DIN 9611 - 6 Keile DIN 9611 - 6 Splines				
Nennmaß¹⁾ Nominal dim.¹⁾	d₁	b₁	d₂	
28,91 x 34,79 x 8,69	70	11	27	

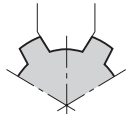

Form A
ohne Höcker without clearance lugs
ohne Kantenbruch without chamfer

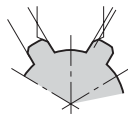

Form B
ohne Höcker without clearance lugs
mit Kantenbruch with chamfer

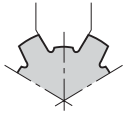

Form C
mit Höcker with clearance lugs
ohne Kantenbruch without chamfer

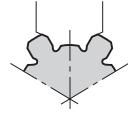

Form E
Schleifmaßfräser
grindling size cutter



für Form A – E Forms A – E
zum Durchfräsen einen Bundes
for through-cutting a shoulder

¹⁾ Nennmaß: Innen-Durchmesser x Außen-Durchmesser x Keilbreite
¹⁾ Nominal dimension: inside dia. x outside dia. x spline width
²⁾ Zapfwellen 2 und 3 auf Anfrage
²⁾ P.t.o. shafts 2 and 3 on request
 Falls nicht anders vorgeschrieben, liefern wir Form D in hinterdrehter Ausführung
 Unless otherwise specified, we supply form D in the relief turned version

Schnittwertempfehlungen ab Seite 582
 Cutting data recommendations starting page 582

für Keilwellen und Zahnwellen
als Satzfräser
6° positiver Spannwinkel
versetzte Keilnuten
1 Satz = 2 Stück, Fräser Nr. 2 mit 2 Längsnuten

for straight sided and involute spline shafts
designed as gang cutters
6° positive rake angle
staggered keyways
1 set = 2 units, cutter No. 2 with 2 keyways

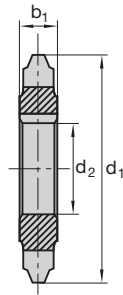

Katalog-Nr.	Cat.-No.	2731
Eingriffswinkel	Pressure angle	20°
Bezugsprofil	Basic profile	-
Drallwinkel	Helix angle	-
Ausführung	Type	hinterschliffen relief ground
Werkstoff	Material	HSS-E-PM

d ₁	b ₁	d ₂	Ident No.
75 - 85	10	40	Auf Anfrage Upon request
75 - 85	12	40	
75 - 85	14	40	
75 - 85	16	40	
75 - 85	18	40	
75 - 85	20	40	

Bei Bestellung benötigen wir Maß- und Toleranzangaben oder Zeichnungen der zu fräsenden Werkstückprofile.
When ordering, please quote dimensional and tolerance data or provide drawings of the workpiece profiles to be machined.

Schnittwertempfehlungen ab Seite 582
Cutting data recommendations starting page 582

**zum Abrunden von Zahnkanten
for chamfering tooth edges**

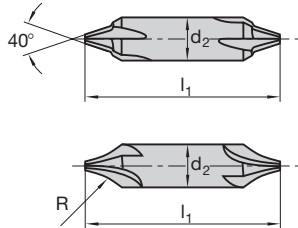

Katalog-Nr.	Cat.-No.	2801	2802	2803	2804
Eingriffswinkel	Pressure angle	20°		-	
Bezugsprofil	Basic profile			-	
Drallwinkel	Helix angle			-	
Ausführung	Type	hinterschliffen relief ground mit geraden Flanken mit geschweiften Flanken with straight flanks with curved flanks			-
Werkstoff	Material	HSS-E			
m	d₂	l₁	Ident No.	Ident No.	Ident No.
1	13	80	1259311	1259918	Auf Anfrage
1,25	13	80	1259320	1259927	Upon request
1,5	13	80	1259339	1259936	
1,75	13	80	1259348	1259945	
2	13	80	1259357	1259954	
2,25	13	80	1259366	1259963	
2,5	13	80	1259375	1259972	
2,75	13	80	1259384	1259981	
3	13	80	1259393	1259990	
3,25	13	80	1259400	1260005	
3,5	13	80	1259419	1260014	
3,75	13	80	1259428	1260023	
4	13	80	1259437	1260032	
4,5	13	80	1259446	1260041	
5	18	80	1259455	1260050	
5,5	18	80	1259464	1260069	
6	18	80	1259473	1260078	
6,5	18	80	1259482	1260087	
7	25	110	1259491	1260096	
8	25	110	1259507	1260103	

Für alle Zähnezahlen einer Modulgröße und für Eingriffswinkel 15° oder 20° ist nur ein Fräser erforderlich
For any number of teeth of one module size and for pressure angles of 15° or 20° only one cutter is required

Schnittwertempfehlungen ab Seite 582
Cutting data recommendations starting page 582

für Trapezgewinde DIN 103
Flankenwinkel 30°¹⁾

for Trapezoidal thread DIN 103
Thread angle 30°¹⁾

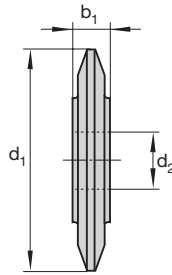
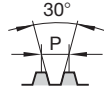

Katalog-Nr.	Cat.-No.	1810
Norm	Standard	DIN 1893
Werkstoff	Material	HSS-E Mo5Co5

P	d ₁ js 16	b k 11	d ₂	z	Ident No.
4	71	8	22	30	1184035
5	71	8	22	30	1184044
6	71	8	22	30	1184053
7	71	8	22	30	1184062
8	71	8	22	30	1184071
9	80	10	22	30	1184080
10	80	10	22	30	1184099
12	80	10	22	30	1184106
14	80	10	22	30	1184115
16	80	12	22	30	1184124
18	100	12	27	30	1184133

¹⁾ Mit Flankenwinkel 29° oder 40° auf Anfrage
¹⁾ With thread angle 29° or 40° upon request

Schnittwertempfehlungen ab Seite 582
Cutting data recommendations starting page 582

für metrische ISO-Gewinde nach DIN 13
für Außengewinde (Bolzensgewinde)¹⁾
oder Innengewinde (Muttergewinde)¹⁾
hinterschliffen

for metric ISO thread to DIN 13
for external threads (male)¹⁾
and internal threads (female)¹⁾
relief ground

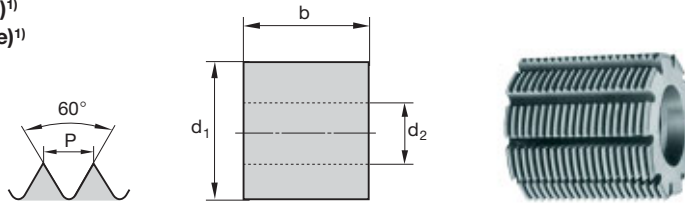

Katalog-Nr.	Cat.-No.	1703
Norm	Standard	DIN 852 D
Typ	Type	N
Drallwinkel	Helix angle	geradegenutet straight fluted
Werkstoff	Material	HSS-E EMO5Co5

P	d ₁ js 16	b k 11	d ₂	z ⚙	Ident No.
1	32	25	13	8	Auf Anfrage
1,25	32	25	13	8	Upon request
1,5	32	25	13	8	
1,5	40	32	16	8	
2	40	32	16	9	
2	40	40	16	9	
2	50	40	22	10	
2	50	50	22	10	
2,5	40	32	16	9	
2,5	40	40	16	9	
2,5	50	40	22	10	
2,5	50	50	22	10	
2,5	63	50	27	12	
2,5	63	63	27	12	
3	40	32	16	9	
3	40	40	16	9	
3	50	40	22	10	
3	50	50	22	10	
3	63	50	27	12	
3	63	63	27	12	

¹⁾ Bei Bestellung bitte „B“ (= Bolzensgewinde) oder „M“ (= Muttergewinde) angeben.
Gewindefräser für andere Gewindeausführungen, drallgenutete Gewindefräser und
Gewinde-Walzbackenfräser oder als Schaftausführung: auf Anfrage.

¹⁾ When ordering, please state “B” (= male thread) or “M” (= female thread).
Thread milling cutters for other thread forms, spiral fluted thread milling cutters and
thread roll bar cutters or in shank type design: upon request.

Schnittwertempfehlungen ab Seite 582
Cutting data recommendations starting page 582

Werkstoff	Material	R _m /UTS (N/mm ²)	HHS-E (v _c m/min)	f _z bei Fräser d ₁ mm f _z at cutter dia. d ₁ mm						Leistungs- faktor Efficiency factor LF
				5	8	12	20	32	> 50	
Unlegierter Baustahl	Plain carbon steel	-700	35	0,03	0,05	0,06	0,08	0,09	0,1	20
Automatenstahl	Free cutting steel	-700	35	0,03	0,05	0,06	0,08	0,09	0,1	20
Baustahl	Structural alloy steel	500-950	28	0,025	0,045	0,06	0,08	0,09	0,1	18
Vergütungsstahl, mittelfest	Heat-treatable steel, medium strength	500-950	28	0,025	0,05	0,06	0,08	0,09	0,1	18
Stahlguß	Cast steel	-950	20	0,025	0,04	0,05	0,08	0,09	0,1	18
Einsatzstahl	Case hardening steel	-950	35	0,03	0,05	0,06	0,08	0,09	0,1	18
Rost- und säurebeständiger Stahl, ferritisch, martensitisch	Stainless steel, ferritic, martensitic	500-950	15	0,025	0,04	0,05	0,06	0,07	0,09	16
Vergütungsstahl, hochfest	Heat-treatable steel, high strength	950-1400	20	0,02	0,04	0,05	0,08	0,09	0,1	13
Nitrierstahl, vergütet	Nitriding steel	950-1400	20	0,02	0,04	0,05	0,08	0,09	0,1	15
Werkzeugstahl	Tool steel	950-1400	20	0,02	0,04	0,05	0,08	0,09	0,1	13
Rost- und säurebeständiger Stahl, austenitisch	Stainless steel, austenitic	500-950	22	0,025	0,05	0,06	0,07	0,08	0,09	15
Martensitaushärtbarer Stahl	Maraging steel		22	0,025	0,05	0,06	0,07	0,08	0,09	15
Grauguß	Grey cast iron	100-400 (120-310 HB)	28	0,04	0,07	0,08	0,1	0,12	0,15	30
Legierter Grauguß	Alloyed grey cast iron	150-250 (160-230 HB)	22	0,03	0,05	0,06	0,08	0,09	0,1	25
Sphäroguß	Nodular cast iron	400-800 (120-310 HB)	35	0,02	0,05	0,06	0,1	0,12	0,15	24
Temperguß	Malleable cast iron	350-700 (150-280 HB)	42	0,02	0,05	0,06	0,1	0,12	0,15	30
Rein-Metalle, weich	Pure metals, soft	-500	100	0,03	0,05	0,06	0,08	0,09	0,1	30
Aluminium-Legierungen, langspanend	Aluminium alloys, long chipping	-550	250	0,03	0,03	0,03	0,03	0,03	0,03	30
Aluminium-Legierungen, kurzspanend	Aluminium alloys, short chipping	-400	70	0,02	0,025	0,03	0,04	0,06	0,1	25
Kupfer-Legierungen, langspanend	Copper alloys, long chipping	300-700	35	0,03	0,05	0,06	0,08	0,09	0,1	30
Kupfer-Legierungen, kurzspanend	Copper alloys, short chipping	-500	42	0,02	0,025	0,03	0,04	0,06	0,09	35
Magnesium-Legierungen	Magnesium alloys	160-300	250	0,04	0,05	0,06	0,08	0,1	0,12	25
Thermoplaste	Thermoplastics	40-70	120	0,03	0,04	0,05	0,06	0,08	0,1	25
Duroplaste	Duroplastics	20-40	70	0,03	0,04	0,05	0,06	0,08	0,1	25
Graphit	Graphite									
Titan-Legierungen, mittelfest	Titanium alloys, medium strength	-950	22	0,014	0,024	0,05	0,08	0,08	0,1	18
Titan-Legierungen, hochfest	Titanium alloys, high strength	900-1400	12	0,01	0,018	0,04	0,06	0,07	0,08	14
Nickelbasis-Legierungen, mittelfest	Nickel based alloys, medium strength	-950	20	0,02	0,048	0,09	0,12	0,09	0,1	18
Nickel-Basis-Legierungen, hochwarmfest	Heat resistant nickel based alloys, high strength	900-1400	10	0,01	0,028	0,06	0,07	0,08	0,09	16
Hartguß gehärteter Stahl	Chilled cast iron hardened steel	300-600	12	0,012	0,04	0,05	0,08	0,09	0,1	25

<p>Drehzahl Speed</p> $n = \frac{v_c \cdot 1000}{\pi \cdot d_1} \cdot f_1$ <p>v_c Tab. Seite 580 Page 580</p>	<p>Vorschubgeschwindigkeit Feed rate</p> $v_f = f_z \cdot z \cdot n \cdot f_2$ <p>f_z Tab. Seite 580 Page 580</p>	<p>a_e = Schnittbreite in mm Width of cut in mm</p> <p>a_p = Schnitttiefe in mm Depth of cut in mm</p> <p>d_1 = Durchmesser in mm Cutter diameter in mm</p> <p>f_1 = Korrekturfaktor für v_c Correction factor v_c</p> <p>f_2 = Korrekturfaktor für v_f Correction factor v_f</p> <p>f_z = Vorschub pro Zahn in mm Feed per tooth in mm</p> <p>LF = Leistungsfaktor in $\text{cm}^3/\text{min}/\text{kW}$ Efficiency factor in $\text{cm}^3/\text{min}/\text{kW}$</p> <p>$n$ = Drehzahl in min^{-1} Speed in min^{-1}</p> <p>P_e = Spindelleistung in kW Drive power in kW</p> <p>Q = Spanvolumen in cm^3/min Chip volume in cm^3/min</p> <p>v_c = Schnittgeschwindigkeit in m/min Cutting speed in m/min</p> <p>v_f = Vorschubgeschwindigkeit in mm/min Feed rate in mm/min</p> <p>z = Anzahl der Schneiden No. of teeth</p>
<p>Spanvolumen Chip volume</p> $Q = \frac{a_e \cdot a_p \cdot v_f}{1000}$	<p>Spindelleistung Drive power</p> $P_e \approx \frac{Q}{\text{LF}}$	

Schnittgeschwindigkeitskorrektur f_1
Cutting speed correction factor f_1

	unbeschichtet uncoated	TiN	TiCN	TiCN Plus	AL PLUS
$f_1 =$	1	1,3	1,6	1,6	1,6

Vorschub-Korrektur f_2
Feed rate correction factor f_2

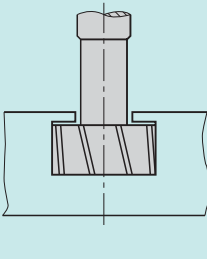
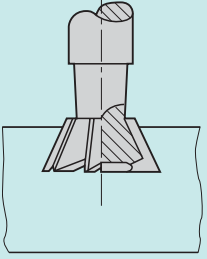
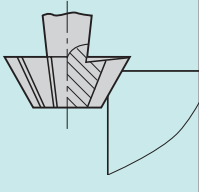
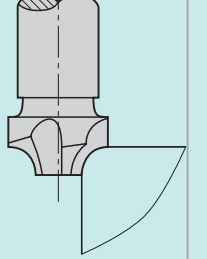
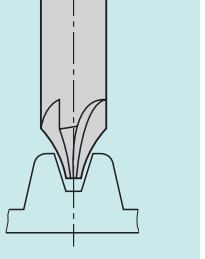
					
	T-Nutenfräser T-Slot Milling Cutters	Winkelfräser Angle Milling Cutters	Viertelrund-Profilfräser Corner Rounding Cutters	Zahn-Abrundfräser Gear Chamfering Cutters	Zahn-Abrundfräser Gear Chamfering Cutters
$f_2 =$	0,5	0,6	1	1	1

Werkstoff	Material	R _m /UTS (N/mm ²)	HHS-E TiN (v _c m/min)	f _z mm				Leistungs- faktor Efficiency factor LF
				Typ 1	Type 1	Typ 2	Type 2	
Unlegierter Baustahl	Plain carbon steel	-700	45	0,06		0,07		20
Automatenstahl	Free cutting steel	-700	45	0,06		0,07		20
Baustahl	Structural alloy steel	500-950	36	0,04		0,06		18
Vergütungsstahl, mittelfest	Heat-treatable steel, medium strength	500-950	36	0,05		0,06		18
Stahlguß	Cast steel	-950	25	0,04		0,05		18
Einsatzstahl	Case hardening steel	-950	45	0,06		0,05		18
Rost- und säurebeständiger Stahl, ferritisch, martensitisch	Stainless steel, ferritic, martensitic	500-950	20	0,04		0,03		16
Vergütungsstahl, hochfest	Heat-treatable steel, high strength	950-1400	25	0,03		0,03		13
Nitrierstahl, vergütet	Nitriding steel	950-1400	16	0,04		0,03		15
Werkzeugstahl	Tool steel	950-1400	16	0,04		0,03		13
Rost- und säurebeständiger Stahl, austenitisch	Stainless steel, austenitic	500-950	28	0,06		0,03		15
Martensitaushärtbarer Stahl	Maraging steel							
Grauguß	Grey cast iron	100-400 (120-310 HB)	36	0,08		0,08		30
Legierter Grauguß	Alloyed grey cast iron	150-250 (160-230 HB)	28	0,06		0,06		25
Sphäroguß	Nodular cast iron	400-800 (120-310 HB)	45	0,06		0,06		24
Temperguß	Malleable cast iron	350-700 (150-280 HB)	56	0,08		0,06		30
Rein-Metalle, weich	Pure metals, soft	-500	200	0,06		0,08		30
Aluminium-Legierungen, langspanend	Aluminium alloys, long chipping	-550	355	0,05		0,07		30
Aluminium-Legierungen, kurzspanend	Aluminium alloys, short chipping	-400	90	0,04		0,06		25
Kupfer-Legierungen, langspanend	Copper alloys, long chipping	300-700	45	0,08		0,08		30
Kupfer-Legierungen, kurzspanend	Copper alloys, short chipping	-500	56	0,08		0,06		35
Magnesium-Legierungen	Magnesium alloys	160-300	355	0,04		0,06		25
Thermoplaste	Thermoplastics	40-70	150	0,05		0,07		25
Duroplaste	Duroplastics	20-40	90	0,06		0,08		25
Graphit	Graphite							
Titan-Legierungen, mittelfest	Titanium alloys, medium strength	-950	22	0,05		0,04		18
Titan-Legierungen, hochfest	Titanium alloys, high strength	900-1400	10	0,04		0,03		14
Nickelbasis-Legierungen, mittelfest	Nickel based alloys, medium strength	-950	25	0,06		0,06		18
Nickel-Basis-Legierungen, hochwarmfest	Heat resistant nickel based alloys, high strength	900-1400	12	0,04		0,04		16
Hartguß gehärteter Stahl	Chilled cast iron hardened steel	300-600	16	0,04		0,03		25

Drehzahl Speed $n = \frac{v_c \cdot 1000}{\pi \cdot d_1} \cdot f_1$ v_c Tab. Seite 582 Page 582	Vorschubgeschwindigkeit Feed rate $v_f = f_z \cdot z \cdot n \cdot f_2$ f_z Tab. Seite 582 Page 582	a_e = Schnittbreite in mm Width of cut in mm a_p = Schnitttiefe in mm Depth of cut in mm d_1 = Durchmesser in mm Cutter diameter in mm f_1 = Korrekturfaktor für v_c Correction factor v_c f_2 = Korrekturfaktor für v_f Correction factor v_f f_z = Vorschub pro Zahn in mm Feed per tooth in mm LF = Leistungsfaktor in $\text{cm}^3/\text{min}/\text{kW}$ Efficiency factor in $\text{cm}^3/\text{min}/\text{kW}$ n = Drehzahl in U/min Speed in min^{-1} P_e = Spindelleistung in kW Drive power in kW Q = Spanvolumen in cm^3/min Chip volume in cm^3/min v_c = Schnittgeschwindigkeit in m/min Cutting speed in m/min v_f = Vorschubgeschwindigkeit in mm/min Feed rate in mm/min z = Anzahl der Schneiden No. of teeth
Spanvolumen Chip volume $Q = \frac{a_e \cdot a_p \cdot v_f}{1000}$	Spindelleistung Drive power $P_e \approx \frac{Q}{\text{LF}}$	

Schnittgeschwindigkeitskorrektur f_1

Cutting speed correction factor f_1

	unbeschichtet uncoated	TiN	TiCN	TiCN Plus	AL Plus
$f_1 =$	0.8	1	1,2	1,2	1,2

Schnittgeschwindigkeitskorrektur f_m / Vorschubkorrektur f_2

Cutting speed correction factor f_m / Feed rate correction factor f_2

Modul m Module m (mm)	1	3	5	10	20	> 30
Teilung T Pitch T (mm)	2,5	10	20	30	-	-
$f_m =$	1	1	0,9	0,85	0,6	0,5
$f_2 =$	1	1	1	1,2	1,5	1,5

Typenzuordnung der Fräser

Type classification

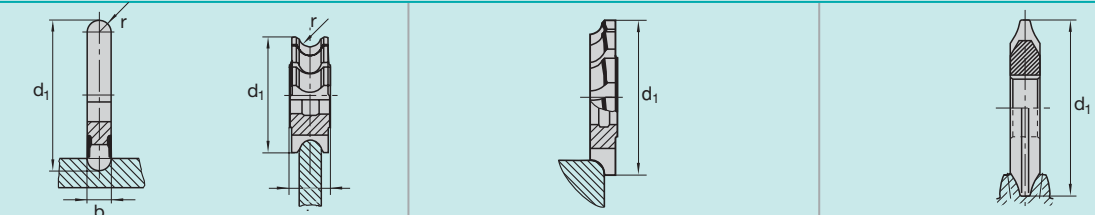
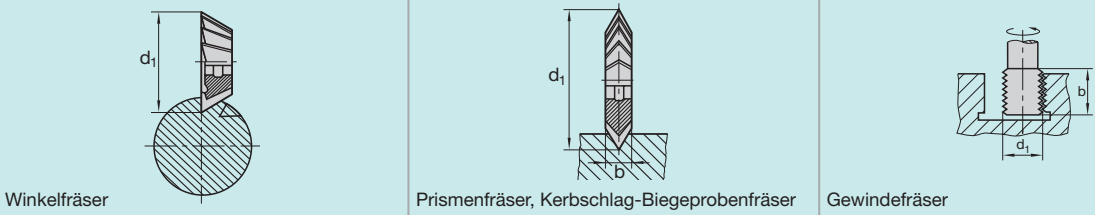
Typ I Type I	Typ II Type II
 Halbrund-Profilfräser konvex, konkav Form-Relieved convex, concave Cutters Viertelrund-Profilfräser Form-Relieved Corner Rounding Cutters Zahnformfräser Involute Gear Cutters	 Winkelfräser Single Angle Milling Cutters Prismenfräser, Kerbschlag-Biegeprobenfräser Double Angle Milling Cutters, Notched-bar Impact Tests Milling Cutters Gewindefräser Involute Gear Cutters

Anhang Attachment

Werkzeugschäfte Tool Shanks

Zylinderschäfte für Bajonettverschluss
Straight shanks Posi-Lock Feature (Weldon)

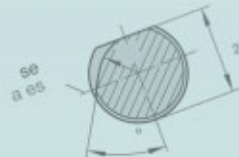
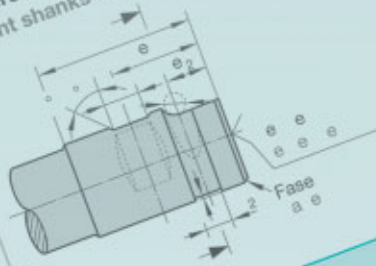

(Darstellung für rechts-
schneidende Werkzeuge)
(Illustration shows R. H.
cutting tools)

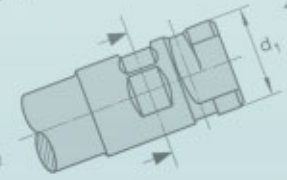

DIN 1835 C		DIN 332 A		d ₁	h ₁	h ₂	h ₃	l ₁
h 6	b ₁ ± 0,05	b ₂ + 0,5	e ₁ 0	F 8	h 13	f 9	h 13	+ 2
40	14	0	-1	10	38	35	36	70
50	18	12	40	12	47,8	44	45	80
63	18	14	45	12	60,8	57	58	90
			50					

Steilkegelschäfte
7/24 taper shanks

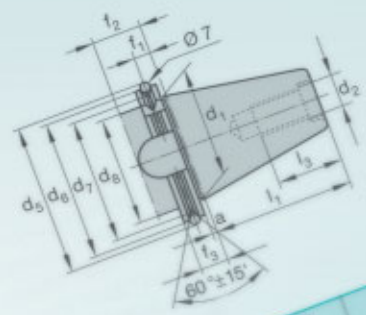

DIN 69871 A		d ₁	d ₂	d ₃	d ₄	d ₅	d ₆	d ₇	d ₈	f ₁	f ₂	f ₃
SK	a	b	M 12	M 16	M 20	M 24	± 0,05	0	max.	± 0,1	min.	0
30	3,2	16,1	31,75	44,45	59,30	72,30	-0,1	50,00	44,30	11,1	35	19,1
40	3,2	16,1	44,45	57,15	72,30	91,35		63,55	56,25	11,1	35	19,1
45	3,2	19,3	57,15	69,85	91,35	107,25		82,55	75,25	11,1	35	19,1
50	3,2	25,7	69,85		107,25	127,25		97,50	91,25	11,1	35	19,1

Steilkegelschäfte mit Trapezritze und zentraler Kühlmittelzufuhr über Bund
7/24 taper shanks with trapezoidal groove and central coolant supply over shoulder



Hierzu Anzug
Seite 000
For use with
page 000

Anhang Attachment

Werkstoffe-Vergleichstabellen Material comparison charts	586
Werkzeugschäfte Tool shanks	590
Werkzeugbohrungen Tool bores	596
Aufnahmemäße nach DIN 8030 Mounting dimensions based on DIN 8030	597
Drallsteigungen Helix angles	598
Berechnung des Eingriffswinkels φ_s Calculation of approach angle φ_s	600
Maße, Einheiten, Anwendungsformeln Dimensions, units and application formulas	601
Härtevergleichstabelle Hardens as comparison table	602
Norm-Bezeichnungen von Werkzeugen nach DIN Standard tool designations to DIN	603
Lösungen von Problemen beim Fräsen Trouble shooting with milling	606

ISO	Deutschland Germany		USA U.S.A.	Frankreich France	Italien Italy	Großbritannien Great Britain	
	W-Nr.	DIN	AISI/SAE	AFNOR	UNI	BS	EN
P	Baustahl und Vergütungsstahl Construction steels						
	1.0050	St50	A570Gr50	A50-2	Fe490	Fe490-2FN	–
	1.0501	C35	1035	CC35	C35	060A35	–
	1.0503	C45	1045	CC45	C45	080M46	–
	1.0601	C60	1060	CC55	C60	080A62	43D
	1.0715	9SMn28	1213	S250	CF9SMn28	230M07	–
	1.0718	9SMnPb28	12L13	S250Pb	CF9SMnPb28	–	–
	1.0722	10SPb20	–	10PbF2	CF10SPb20	–	–
	1.1141	Ck15	1015	XC12	C16	080M15	32C
	1.1157	40Mn4	1039	35M5	–	150M36	15
	1.1158	Ck25	1025	–	–	–	–
	1.1167	36Mn5	1335	40M5	–	–	–
	1.1191	Ck45	1045	XC42	C45	080M46	–
	1.1203	Ck55	1055	XC55	C50	070M55	–
	1.1221	Ck60	1060	XC60	C60	080A62	43D
	1.1274	Ck101	1095	–	–	060A96	–
	1.3401	X120Mn12	–	Z120M12	G-X120Mn12	Z120M12	–
	1.3505	100Cr6	52100	100C6	100Cr6	534A99	31
	1.5026	100Cr6	9255	55S7	55Si8	250A53	45
	1.5415	15Mo3	ASTM A204Gr.A	15D3	16Mo3KW	1501-240	–
	1.5622	14Ni6	ASTM A350LF5	16N6	14Ni6	–	–
	1.5662	X8Ni9	ASTM A353	–	X10Ni9	1501-509;510	–
	1.5680	12Ni19	2515	Z18N5	–	–	–
	1.5710	36NiCr6	3135	35NC6	–	640A35	111A
	1.5752	14NiCr14	3415; 3310	12NC15	–	655M13	36A
						655A12	
	1.6511	36CrNiMo4	9840	40NCD3	38NiCrMo4(KB)	816M40	110
	1.6546	40NiCrMo22	8740	–	40NiCrMo2(KB)	311-Type 7	–
	1.6580	30CrNiMo8	–	30CrNiMo8	30CrNiMo8	–	–
	1.6587	17CrNiMo6	–	18NCD6	–	820A16	–
	1.6657	14NiCrMo134	–	–	15NiCrMo13	832M13	36C
	1.7015	15Cr3	5015	12C3	–	523M15	–
	1.7033	34Cr4	5132	32C4	34Cr4(KB)	530A32	18B
	1.7131	16MnCr5	5115	16MC5	16MnCr5	(527M20)	–
	1.7176	55Cr3	5155	55C3	–	527A60	48
	1.7218	25CrMo4	4130	25CD4	25CrMo4(KU)	1717CDS110	–
	1.7220	34CrMo4	4137; 4135	35CD4	35CrMo4	708A37	19B
	1.7225	42CrMo4	4140	42CD4	42CrMo4	708M40	19A
	1.7335	13CrMo4 4	ASTM A182 F11	15CD3.5	14CrMo4 5	1501-620Gr27	–
			F12	15CD4.5			
	1.7361	32CrMo12	–	30CD12	32CrMo12	722M24	40B
	1.7380	10CrMo9 10	ASTM A182 F.22	12CD9, 10	12CrMo9, 10	1501-622 Gr.31;45	–
	1.7715	14MoV6 3	–	–	–	1503-660-440	–
	1.8159	50CrV4	6150	50CV4	50CrV4	735A50	47
	1.8504	34CrAl6	–	–	–	–	–
1.8509	41CrAlMo7	–	40CAD6, 12	41CrAlMo7	905M39	41B	
1.8523	39CrMoV13 9	–	–	36CrMoV12	897M39	40C	

ISO	Deutschland Germany		USA U.S.A.	Frankreich France	Italien Italy	Großbritannien Great Britain		
	W-Nr.	DIN	AISI/SAE	AFNOR	UNI	BS	EN	
P	Werkzeugstähle Tool steels							
	1.1545	C105W1	–	Y1105 C100KU	C98KU	–	–	
	1.2067	100Cr6	L3	Y100C6	–	BL3	–	
	1.2080	X210Cr12	D3	Z200C12 X250Cr12KU	X210Cr13KU	BD3	–	
	1.2343	X38CrMoV5 1	H11	Z38CDV5	X37CrMoV51(KU)	BH11	–	
	1.2344	X40CrMoV5 1	H13	Z40CDV5 X40CrMoV511KU	X35CrMoV05KU	BH13	–	
	1.2363	X100CrMoV 5 1	A2	Z100CDV5	X100CrMoV51KU	BA2	–	
	1.2379	X155CrVMo12 1	D2	Z160CDV12	X155CrVMo121(KU)	BD2	–	
	1.2419	105WCr6	–	105WC13 107WCr5KU	10WCr6	–	–	
	1.2436	X210CrW12	–	–	X215CrW12 1KU	–	–	
	1.2542	45WCrV7	S1	–	45WCrV8KU	BS1	–	
	1.2581	X30WCrV9 3	H21	Z30WCV9 X30WCrV9 3KU	X28W09KU	BH21	–	
	1.2601	X165CrMoV12	–	–	X165CrMoW12KU	–	–	
	1.2713	55NiCrMoV6	L6	55NCDV7	–	–	–	
	1.2833	100V1	W210	Y1105V	–	BW2	–	
	1.3243	S 6-5-2-5	M41	Z85WDKCV	HS 6-5-2-5	–	–	
	Nichtrostende und wärmefeste Stähle Stainless and heat resistant steels							
	1.4016	X8Cr17	430	Z8C17	X8Cr17	430S15	60	
	1.4027	G-X20Cr14	–	Z20C13M	–	420C29	56B	
	1.4034	X46Cr13	–	Z40CM Z38C13M	X40Cr14	420S45	56D	
1.4057	X22CrNi17	431	Z15CNI6.02	X16CrNi16	431S29	57		
1.4104	X12CrMoS17	430F	Z10CF17	X10CrS17	–	–		
1.4113	X6CrMo17	434	Z8CD17.01	X8CrMo17	434S17	–		
1.4122	X35CrMo17	–	–	–	–	–		
1.4313	X5CrNi13 4	–	Z4CND13.4M	–	425C11	–		
1.4718	X45CrSi9 3	HW3	Z45CS 9	X45CrSi8	401S45	52		
1.4724	X10CrAl13	405	Z10C13	X10CrAl12	403S17	–		
1.4742	X10CrAl18	430	Z10CAS18	X8Cr17	430S15	60		
1.4747	X80CrNiSi20	HNV6	Z80CSN20.02	X80CrSiNi20	443S65	59		
1.4762	X10CrAl24	446	Z10CAS24	X16Cr26	–	–		
1.4871	X53CrMnNiN 219	EV8	Z52CMN21.09	X53CrMnNiN21 9	349S54	–		

ISO	Deutschland Germany		USA U.S.A.	Frankreich France	Italien Italy	Großbritannien Great Britain	
	W-Nr.	DIN	AISI/SAE	AFNOR	UNI	BS	EN
M	1.4301	X5CrNi189	304	Z6CN18.09	X5CrNi18 10	304S15	58E
	1.4305	X12CrNiS18 8	303	Z10CNF18.09	X10CrNiS 18.09	303S21	58M
	1.4308	G-X6CrNi18 9	–	Z6CN18.10M	–	304C15	–
	1.4311	X2CrNiN 18 10	304LN	Z2CN18.10	–	304S62	–
	1.4362	X2CrNiN 23 4	S32304	–	–	–	–
	1.4401	X5CrNiMo 18 10	316	Z6CND17.11	X5CrNiMo17 12	316S16	–
	1.4408	G-X6CrNiMo 18 10	–	–	–	316C16	–
	1.4417	X2CrNiMoSi 19 5	S31500	–	–	–	–
	1.4429	X2CrNiMoN 18 13	316LN	Z2CND17.13	–	–	–
	1.4438	X2CrNiMo18 16	317L	Z2CND19.15	X2CrNiMo18 16	317S12	–
	1.4460	X8CrNiMo27 5	S32900	–	–	–	–
	1.4462	X2CrNiMoN 22 53	S31803	–	–	–	–
	1.4541	X10CrNiTi 18 9	321	Z6CNT18.10	X6CrNiTi18 11	2337	321S12
	1.4542	X5CrNiCuNb174	J467	–	–	–	–
	1.4550	X10CrNiNb 18 9	347	Z6CNNb18.10	X6CrNiNb18 11	347S17	58F
	1.4571	X10CrNiMo18 10	316Ti	Z6NDT17.12	X6CrNiMoTi1712	320S17	58J
	1.4581	G-X5CrNi	–	Z4CNDNb	XG8CrNiMo	318C17	–
		MoNb 18 10	–	18 12M	18 11	–	–
	1.4583	X10CrNi	318	Z6CNDNb	X6CrNiMoNb	–	–
		MoNb 18 12	–	17 13B	17 13	–	–
	1.4828	X15CrNiSi20 12	309	Z15CNS20.12	–	309S24	–
	1.4845	X12CrNi25 21	310S	Z12CN25 20	X6CrNi25 20	310S24	–
	1.4864	X12NiCrSi36 16	330	Z12NCS35.16	–	–	–
	1.4865	G-X40NiCrSi38 18	–	–	XG50NiCr39 19	330C11	–
1.4878	X12CrNiTi18 9	321	Z6CNT18.12B	X6CrNiTi1811	32S12	58B	
			189		321S20	58C	
K	Grauguss (unlegiert) Grey cast iron (plain carbon)						
	0.6015	GG15	No 25B	Ft 15 D	–	Grade 150	–
	0.6025	GG25	No 35B	Ft 25 D	–	Grade 260	–
	0.6035	GG35	No 50B	Ft 35 D	–	Grade 350	–
	0.6040	GG40	No 55B	Ft 40 D	–	Grade 400	–
	Grauguss (legiert) Grey cast iron (alloy)						
	0.6660	GGL-NiCr 20 2	A436-72	L-NC 20 2	–	L-NiCr 20 2	–
	0.6678	GGL-NiCr 35 2	–	–	–	–	–
	Kugelgraphitguss (unlegiert) Spheroidal graphite cast iron (plain carbon)						
	0.7040	GGG 40	60-40-18	FCS 400-12	–	SNG 420/12	–
	0.7060	GGG 60	–	FGS 600-3	–	SNG 600/3	–
	0.7070	GGG 70	100-70-03	FGS 700-2	–	SNG 700/2	–
	Kugelgraphitguss (legiert) Spheroidal graphite cast iron (alloy)						
	0.7652	GGG NiMn 137	–	L-NM 137	–	L-NiMn 13 7	–
	0.7660	GGG NiCr 20 2	–	L-NC 20 2	–	L-NiMn 20 2	–
	Temperguss Malleable cast iron						
	0.8135	GTS-35	32510	MN 35-10	–	B 340/12	–
	0.8155	GTS-55	50005	MP 50-5	–	P 510/4	–
	0.8170	GTS-70	–	IP 70-2	–	P 690	–

ISO	Deutschland Germany		USA U.S.A.	Frankreich France	Italien Italy	Großbritannien Great Britain	
	W-Nr.	DIN	AISI/SAE	AFNOR	UNI	BS	EN
N	NE-Schwermetall-Legierungen Non-ferrous heavy metal alloys						
	2.0321	CuZn37(Ms63)	C27400	CuZn37	P-CuZn37	CZ 108	
	2.0402	CuZn40Pb2(Ms58)	C37700	CuZn39Pb2	P-CuZn3940Pb2	CZ 122	
	2.0550	CuZn40Al2				CZ 135	
	2.0780	CuNi12Zn30Pb					
	2.0882	CuNi30Fe	C71500	CuNi30Mn1Fe	CuNi30Mn1Fe	CN107	
	2.0975	CuAl10Ni	C95800	CuAl10Fe5Ni5	CuAl11Fe4Ni4	AB2	
	2.1080	CuSn6Zn					
	2.1498	CuSP			CuS(P0,01)		
	2.3205	PbSb5					
	2.3290	PbSb9					
	Leichtmetall-Legierungen Light metal alloys						
	3.1355	AlCuMg2	AA 2024	2024	2024	2024	AW-2024
	3.1645	AlCuMgPb					-2007
	3.2581.01	G-AlSi12	B413.0	A-S 13	3051/G-AS9MG	LM6	AC-44200
	3.3527	AlMg2Mn0,8					AW-5049
	3.3535	AlMg3	AA 5754	5754			-5754
	3.4365	AlZnMgCu1,5	AA 7075	7075	7075	7075	-7075
	3.5161	MgZn6ZrF30					
3.5312	MgAl3ZnF25						
3.5912	G-MgAl9Zn1						
3.7115	TiAl5Sn2,5	ASTM: B 265	T-A5E		TA14,17		
3.7165	TiAl6V4			T-A6V	TA10-13/TA28		
3.7174	TiAl6V6Sn2	4971					
S	Hochwärmfeste Werkstoffe High-temperature materials						
	Handels- name Tradename						
	HS-27	NiCo32Cr26Mo			KC20WN		
	Hastelloy-C	NiCr17Ho17FeW	5388C	NC17DWY			
	Inconel 718	NiCr19Fe19-NbMo	5838		NC19FeNb		HR8
	Lescalloy	NiCr16FeTi					
	Nimonic90	NiCr20Co18Ti					
	Unitemp	NiCr16Co8WAlTi					
	Vakumell	NiCr20TiAl					
	Vakumelt	NiCo10Cr9WAlTi					

Fette-Präzisionswerkzeuge erfüllen alle Voraussetzungen für einen zuverlässigen, reibungslosen Einsatz sowohl auf konventionellen als auch auf NC- und CNC-Werkzeugmaschinen.

Die für die NC-Programmierung erforderlichen Maßangaben (\varnothing , Länge) des Spannmittels vor der Maschinenspindel finden Sie in der Baumaßtabelle bei der jeweiligen Spannmittel-Katalognummer.

Fette precision tools satisfy all criteria for reliable, trouble-free use also on NC and CNC machine tools.

The measurements (dia., length) of the clamping fixture in front of the machine spindle, needed for NC programming, are given in the size table under the corresponding clamping fixture catalogue number.

Zylinderschäfte Straight shanks				DIN 1835 A		DIN 6535 HA	
d_1	l_1 + 2	l_5	Zentrierung Center bore	d_1	l_1 + 2		
h 6	0			h 6	0		
6	36	0,8	1,60 x 2,50	6	36		
8	36	0,8	1,60 x 3,35	8	36		
10	40	1,0	1,60 x 3,35	10	40		
12	45	1,2	1,60 x 3,35	12	45		
16	48	1,6	2,00 x 4,25	14	45		
20	50	2,0	2,50 x 5,30	16	48		
25	56	2,0	2,50 x 5,30	18	48		
32	60	2,0	3,15 x 6,70	20	50		
40	70	2,0	4,00 x 8,50	25	56		
50	80	2,0	4,00 x 8,50	32	60		
63	90	2,0	4,00 x 8,50				

Zylinderschäfte mit seitlicher Mitnahmefläche Straight shanks with clamping flat

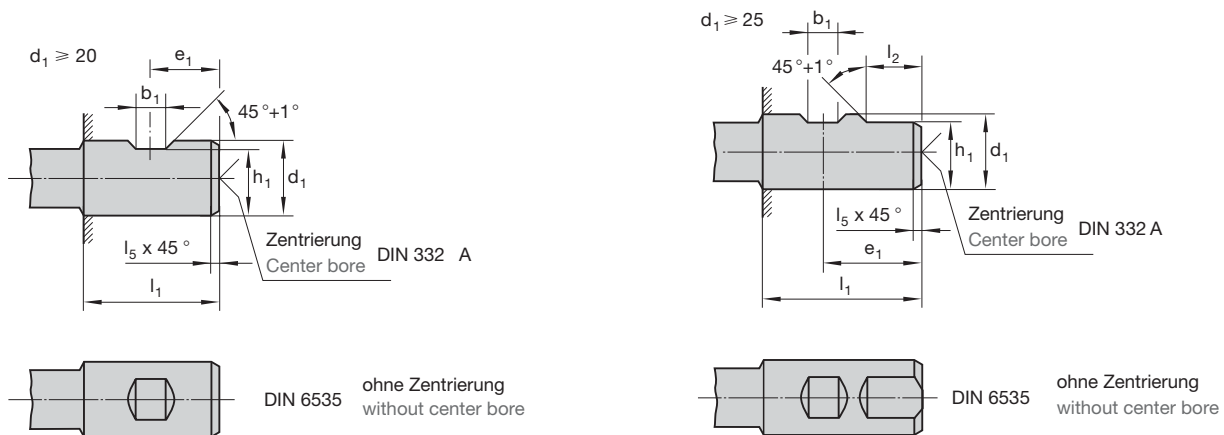

DIN 1835 B								DIN 6535 HB						
d_1	l_1 + 2	l_5	e_1 0	b_1 + 0,05	l_2 + 1	h_1	Zentrierung Center bore	d_1	b_1 + 0,05	e_1 0	h_1	l_1 + 2	l_2 + 1	
h 6	0		- 1	0	0	h 13		h 6	0	- 1	h 11	0	0	
6	36	0,8	18	4,2		4,8	1,60 x 2,50	6	4,2	18	5,1	36		
8	36	0,8	18	5,5		6,6	1,60 x 3,35	8	5,5	18	6,9	36		
10	40	1,0	20	7		8,4	1,60 x 3,35	10	7	20	8,5	40		
12	45	1,2	22,5	8		10,4	1,60 x 3,35	12	8	22,5	10,9	45		
16	48	1,6	24	10		14,2	2,00 x 4,25	14	8	22,5	12,7	45		
20	50	2,0	25	11		18,2	2,50 x 5,30	16	10	24	14,2	48		
25	56	2,0	32	12	17	23	2,50 x 5,30	18	10	24	16,2	48		
32	60	2,0	36	14	19	30	3,15 x 6,70	20	11	25	18,2	50		
40	70	2,0	40	14	19	38	4,00 x 8,50	25	12	32	23	56	17	
50	80	2,0	45	18	23	47,8	4,00 x 8,50	32	14	36	30	60	19	
63	90	2,0	50	18	23	60,8	4,00 x 8,50							

Zylinderschäfte mit Anzugsgewinde Straight shanks with draw-bar thread

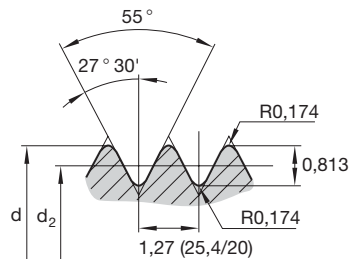
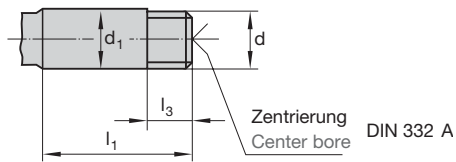

DIN 1835 D

d ₁	d	d ₂	l ₁ + 2 0	l ₃ + 2 0	Zentrierung Center bore
h 6					
6	5,9 ^{-0,1}	5,087 ^{-0,1}	36	10	1,60 x 2,50
10	9,9 ^{-0,1}	9,087 ^{-0,1}	40	10	1,60 x 3,35
12	11,9 ^{-0,1}	11,087 ^{-0,1}	45	10	1,60 x 3,35
16	15,9 ^{-0,1}	15,087 ^{-0,1}	48	10	2,00 x 4,25
20	19,9 ^{-0,15}	19,087 ^{-0,15}	50	15	2,50 x 5,30
25	24,9 ^{-0,15}	24,087 ^{-0,15}	56	15	2,50 x 5,30
32	31,9 ^{-0,15}	31,087 ^{-0,15}	60	15	3,15 x 6,70

Zylinderschäfte mit geneigter Spannfläche Straight shanks with whistle notch

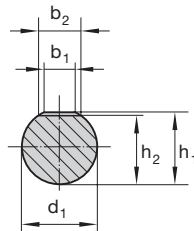
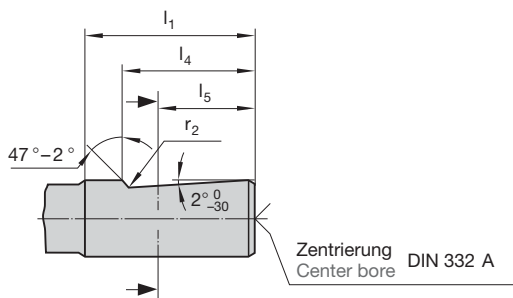

DIN 1835 E

d ₁	h ₂	l ₁ + 2 0	l ₄ 0 - 1	l ₅	r ₂ min.	Zentrierung Center bore	(b ₁) ≈	(b ₂)	(h ₁)
h 6	h 13								
6	4,8	36	25	18	1,2	1,60 x 2,50	3,5	4,8	5,4
8	6,6	36	25	18	1,2	1,60 x 3,35	4,7	6,1	7,2
10	8,4	40	28	20	1,2	1,60 x 3,35	5,7	7,3	9,1
12	10,4	45	33	22,5	1,2	1,60 x 3,35	6	8,2	11,2
16	14,2	48	36	24	1,6	2,00 x 4,25	7,6	10,1	15
20	18,2	50	38	25	1,6	2,50 x 5,30	8,4	11,5	19,1
25	23	56	44	32	1,6	2,50 x 5,30	9,3	13,6	24,1
32	30	60	48	35	1,6	3,15 x 6,70	9,9	15,5	31,2

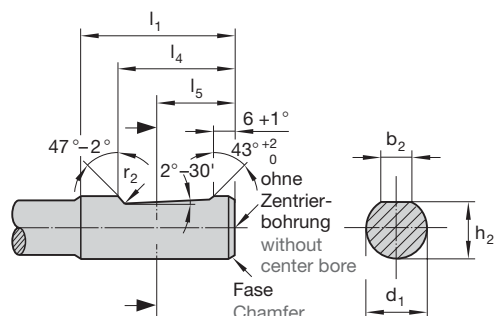

DIN 6535 HE

d ₁	h ₂	l ₁ + 2 0	l ₄ 0 - 1	l ₅	r ₂ min.	b ₂ ≈
h 6	h 11					
6	5,1	36	25	18	1,2	4,3
8	6,9	36	25	18	1,2	5,5
10	8,5	40	28	20	1,2	7,1
12	10,4	45	33	22,5	1,2	8,2
14	12,7	45	33	22,5	1,2	8,1
16	14,2	48	36	24	1,6	10,1
18	16,2	48	36	24	1,6	10,8
20	18,2	50	38	25	1,6	11,4

Zylinderschäfte für Bajonettverschluss Straight shanks Posi-Look Feature (Weldon)

(Darstellung für rechts-
schneidende Werkzeuge)
(Illustration shows R. H.
cutting tools)

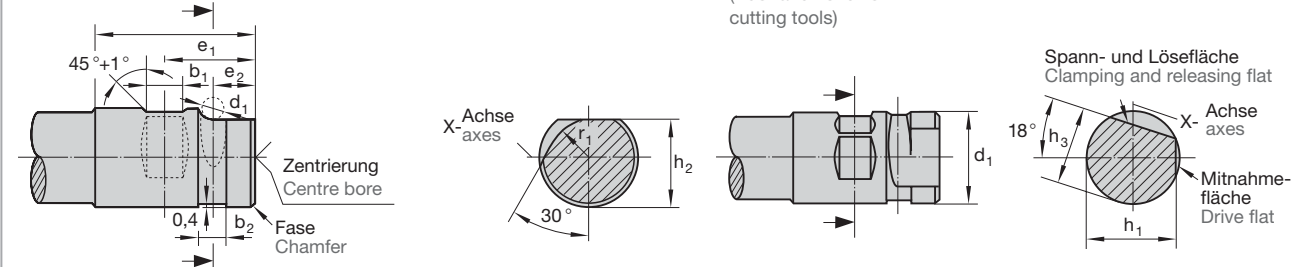

DIN 1835 C

DIN 332 A

d ₁	b ₁	b ₂ + 0,5	e ₁ 0	e ₂ + 0,5	d _i	h ₁	h ₂	h ₃	l ₁ + 2	r ₁
h 6	± 0,05	0	- 1	0	F 8	h 13	f 9	h 13	0	
40	14	12	40	17	10	38	35	36	70	15
50	18	14	45	21	12	47,8	44	45	80	19
63	18	14	50	21	12	60,8	57	58	90	25,5

Steilkegelschäfte 7/24 taper shanks

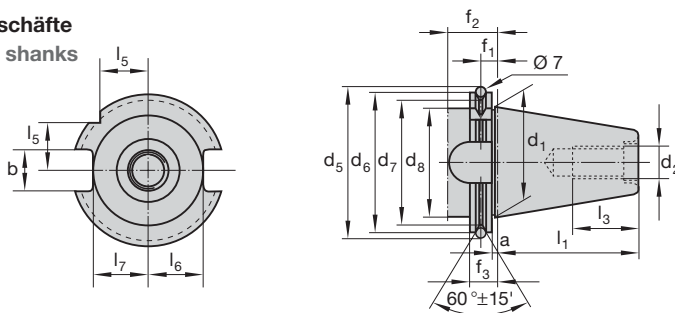

Hierzu Anzugsbolzen siehe Kat.-Nr. 9559
LMT-Katalog „Spannen“ ab Seite 221
For use with pull studs see Cat.-No. 9559
LMT Catalogue “Chucking” starting page 221

DIN 69871 A

SK	a	b	d ₁	d ₂	d ₅	d ₆ 0	d ₇ 0	d ₈	f ₁	f ₂	f ₃ 0	l ₁ 0	l ₃	l ₅ 0	l ₆ 0	l ₇ 0
	± 0,1	H 12			± 0,05	- 0,1	- 0,5	max.	± 0,1	min.	- 0,1	- 0,3	min.	- 0,3	- 0,4	- 0,4
30	3,2	16,1	31,75	M 12	59,30	50,00	44,30	45	11,1	35	19,1	47,80	24	15	16,4	19
40	3,2	16,1	44,45	M 16	72,30	63,55	56,25	50	11,1	35	19,1	68,40	32	18,5	22,8	25
45	3,2	19,3	57,15	M 20	91,35	82,55	75,25	63	11,1	35	19,1	82,70	40	24	29,1	31,3
50	3,2	25,7	69,85	M 24	107,25	97,50	91,25	80	11,1	35	19,1	101,75	47	30	35,5	37,7

Steilkegelschäfte mit Trapezrinne und zentraler Kühlmittelzufuhr über Bund 7/24 taper shanks with trapezoidal groove and central coolant supply over shoulder

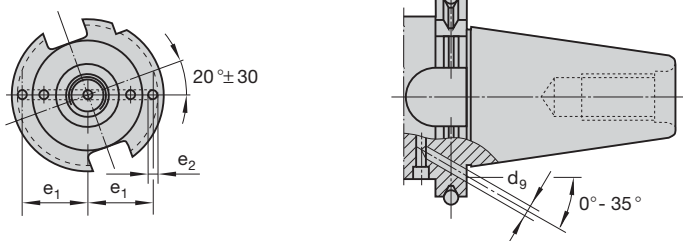

Die Hilfsbohrung bei Form B muß für einen Betriebsdruck bis 50 bar abgedichtet sein. Ausführung nach Wahl des Herstellers. Kegelwinkel-Toleranzqualität des Steilkegelschaftes AT 4 nach DIN 2080 Teil 1.

The supplement on Form B has to be sealed for pressure of 50 bar. Design in accordance with the selection manufactures. Included taper angle tolerance quality of the 7/24 taper shank AT 4 to DIN 2080 Part 1.

Hierzu Anzugsbolzen DIN 69872 siehe Kat.-Nr. 9559 LMT-Katalog „Spannen“ ab Seite 221
For use with pull studs DIN 69872 see Cat.-No. 9559 LMT Catalogue “Chucking” starting page 221

Die übrigen Maße wie Steilkegelschäfte nach DIN 69871 A.
All other dimensions such as for 7/24 taper shanks to DIN 69871 A

DIN 69871 B

SK	d ₉	e ₁ ± 0,1	e ₂ max.
30	4	21	5
40	4	27	5
45	5	35	6
50	6	42	7

Steilkegelschäfte 7/24 taper shanks

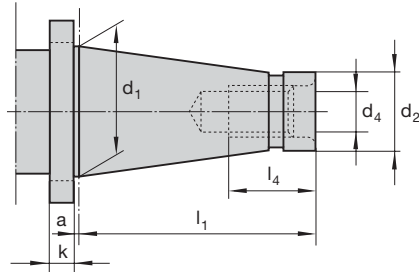
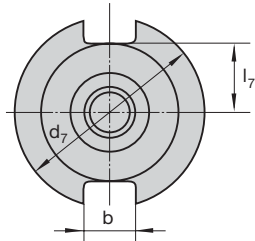

SK 40 mit Maho-Ringnut SK 40 with Maho Ring Groove

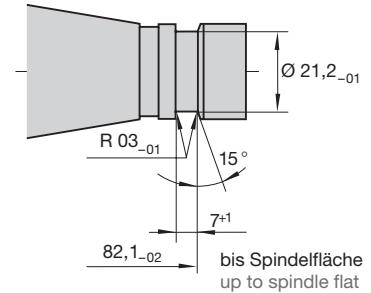

DIN 2080

SK	a ± 0,2	b H 12	d ₁	d ₂ a 10	d ₄	d ₇ 0 - 0,4	k ± 0,15	l ₁	l ₄	l ₇ max.
30	1,6	16,1	31,75	17,4	M 12	50	8	68,4	24	16,2
40	1,6	16,1	44,45	25,3	M 16	63	10	93,4	32	22,5
45	3,2	19,3	57,15	32,4	M 20	80	12	106,8	40	29
50	3,2	25,7	69,85	39,6	M 24	97,5	12	126,8	47	35,3
60	3,2	25,7	107,95	60,2	M 30	156	16	206,8	59	60

Morsekegelschäfte mit Anzugsgewinde Morse taper shanks with draw-bar thread

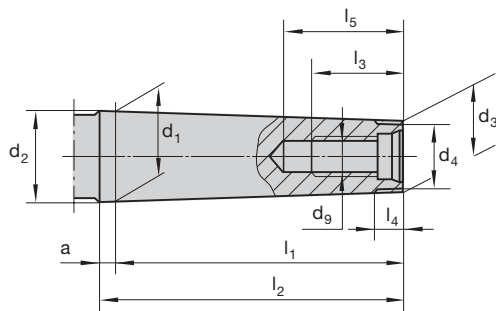

Mit Bund With shoulder

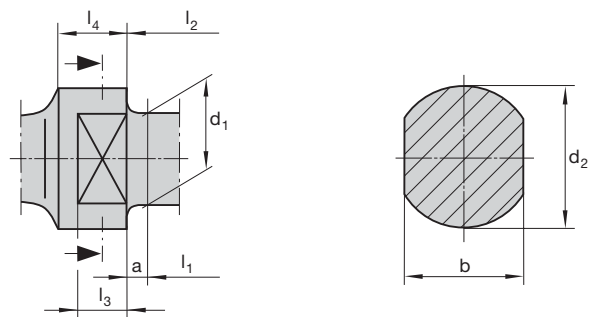

DIN 228 A

DIN 2207

MK	a	d ₁	d ₂ ≈	d ₃ ≈	d ₄ max.	d ₉	l ₁ max.	l ₂ max.	l ₃ min.	l ₄	l ₅ min.	Mit Bund With shoulder			
												b d 9	d ₂	l ₃	l ₄
0	3,0 ^{+1,2}	9,045	9,2	6,4	6	-	50	53	-	4	-				
1	3,5 ^{+1,4}	12,065	12,2	9,4	9	M 6	53,5	57	16	5	22				
2	5,0 ^{+1,4}	17,780	18,0	14,6	14	M 10	64	69	24	5	31,5				
3	5,0 ^{+1,7}	23,825	24,1	19,8	19	M 12	81	86	24	7	33,5	24	24	12	18
4	6,5 ^{+1,9}	31,267	31,6	25,9	25	M 16	102,5	109	32	9	42,5	32	32	15	23
5	6,5 ^{+1,9}	44,399	44,7	37,6	35,7	M 20	129,5	136	40	10	52,5	45	45	18	28
6	8,0 ^{+2,3}	63,348	63,8	53,9	51	M 24	182	190	47	16	61,5	65	65	25	39

Morsekegelschäfte mit Austreibblappen Morse taper shanks with tang

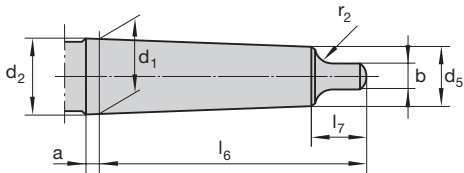

DIN 228 B

MK	a	b	d ₁	d ₁	d ₅	l ₆	max.	r ₂
		h 13		≈	≈	0	l₇	
0	3,0 ^{+1,2}	3,9	9,045	9,2	6,1	56,5	10,5	4
1	3,5 ^{+1,4}	5,2	12,065	12,2	9,0	62,0	13,5	5
2	5,0 ^{+1,4}	6,3	17,780	18,0	14,0	75,0	16	6
3	5,0 ^{+1,7}	7,9	23,825	24,1	19,1	94,0	20	7
4	6,5 ^{+1,9}	11,9	31,267	31,6	25,2	117,5	24	8
5	6,5 ^{+1,9}	15,9	44,399	44,7	36,5	149,5	29	10
6	8,0 ^{+2,3}	19,0	63,348	63,8	52,4	210,0	40	13

BT-Schäfte

BT-Shanks

für automatische Werkzeugwechsler
for automatic tool changes

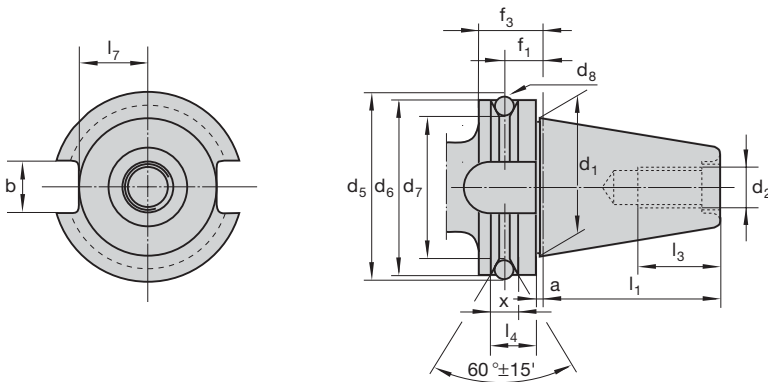

für JMTBA-Standard MAS 403-1975 to JMTBA-Standard MAS 403-1975

(JMTBA = Japan Machine Tool Builders Association)

BT	a	b	d ₁	d ₂	d ₅	d ₆	d ₇	d ₈	f ₁	f ₃	l ₁	l ₃	l ₄	l ₇	x
		H 12			- 0,37	h 8	- 0,5	+ 0,1	± 0,1		± 0,2	min.	min.	± 0,1	
BT 30	1,6	16,1	31,75	M 12	56,144	46	38	8	13,6	21,6	48,4	24	17	16,2	4
BT 40	1,6	16,1	44,45	M 16	75,679	63	53	10	16,6	26,6	65,4	30	21	22,5	5
BT 45	3,2	19,3	57,15	M 20	100,215	85	73	12	21,2	33,2	82,8	38	26	29	6
BT 50	3,2	25,7	69,85	M 24	119,019	100	85	15	23,2	38,2	101,8	45	31	25,3	7

Anhang Attachment

Werkzeugschäfte Tool Shanks

Hohlschaftkegel mit Plananlage (HSK)

für automatischen Werkzeugwechsel
nach DIN 69893 – Teil 1 (Form A)

Der Kegel-Hohlschaft weist aufgrund des kegeligen Schaftes und der Plananlage eine große Positioniergenauigkeit und hohe Steifigkeit auf. Außerdem ist er für rotierende und stehende Werkzeuge sowie Meßzeuge geeignet.

Der Kegel-Hohlschaft nach DIN 69893 soll den Steilkegel für automatischen Werkzeugwechsel nach DIN 69871 Teil 1 ergänzen bzw. ersetzen. Gegenseitige Austauschbarkeit besteht nicht.

Hollow Tapered Shanks with face contact (HSK)

for automatic tool change
to DIN 69893 – Part 1 (Form A)

Due to the tapered shank and face contact, a high positioning accuracy, and high grade of rigidity is suited for use with rotary and stationary tools including measuring instruments.

The Taper Hollow Shank to DIN 69893 supplements the Steep Taper for automatic Tool Changers to DIN 69871 Part 1. Reciprocal interchangeability is not given.

Form A

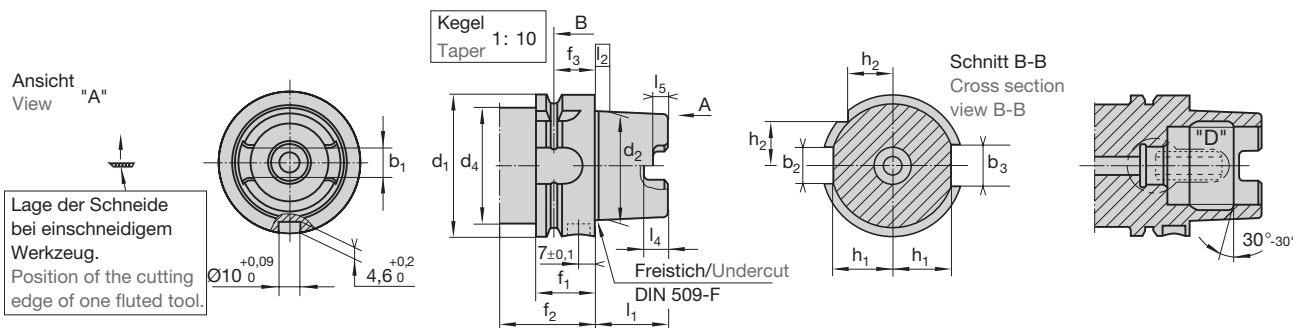

Form C

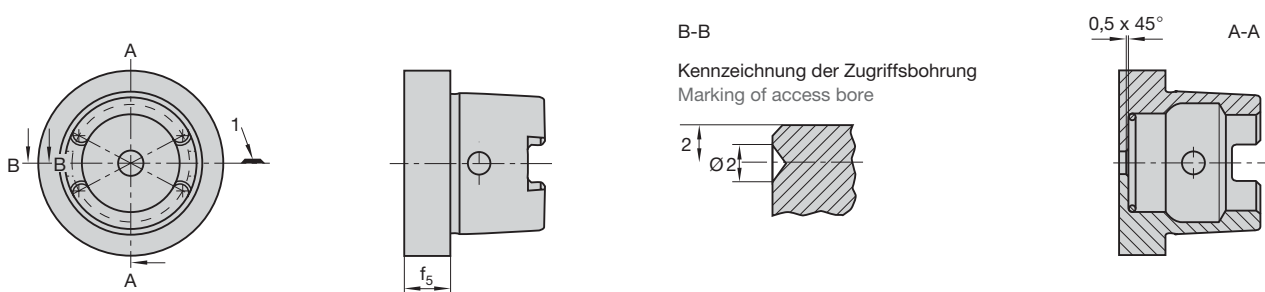

Nenngröße Nominal size d_1 H10	b_1 H10	b_2 H10	b_3 H10	d_2	d_4 max.	f_1 0 -0,1	f_2 min.	f_3 $\pm 0,1$	h_1 0 -0,2	h_2 0 -0,3	l_1 0 -0,2	l_2	l_4 +0,2 0	l_5 +0,2 0
32	7	7	9	24	26	20	35	16	13	9,5	16	3,2	5	3
40	8	9	11	30	34		35	16	17	12	20	4	6	3,5
50	10,5	12	14	38	42	26	42	18	21	15,5	25	5	7,5	4,5
63	12,5	16	18	48	53	25	42	18	26,5	20	32	6,3	10	6
80	16	18	20	60	67	26	42	18	34	25	40	8	12	8
100	20	20	22	75	85	29	45	20	44	31,5	50	10	15	10
125	25	25	28	95	105		45	20	55,5	39,5	63	12,5	19	12
160	30	32	36	120	130	31	47	22	72	50	80	16	23	16

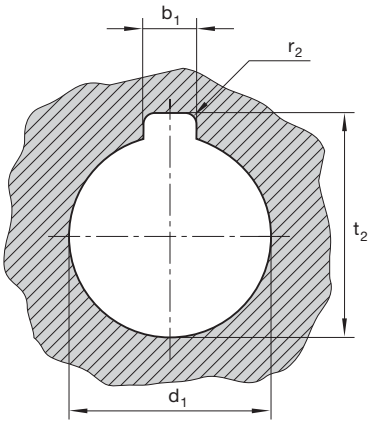
mit Längsnut with standard keyway	DIN 138			
	d	b ₁ c 11	t ₂	r ₂
	13	3	14,6 + 0,1	0,6 - 0,2
	16	4	17,7 + 0,1	0,6 - 0,2
	22	6	24,1 + 0,2	1,0 - 0,3
	27	7	29,8 + 0,2	1,0 - 0,3
	32	8	34,8 + 0,2	1,2 - 0,3
	40	10	43,5 + 0,2	1,2 - 0,3
	50	12	53,6 + 0,2	1,6 - 0,3
	60	14	64,2 + 0,2	1,6 - 0,3

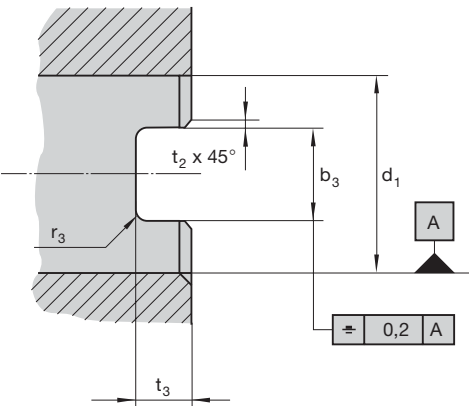
mit Quernut with drive slot	DIN 138				
	d	b ₃ H 11	t ₃ H 12	r ₃	t ₂
	13	8,4	5,0	1 - 0,2	0,5 + 0,1
	16		5,6	1 - 0,3	0,6 + 0,2
	22	10,4	6,3	1,2 - 0,3	0,6 + 0,2
	27	12,4	7,0	1,2 - 0,3	0,8 + 0,2
	32	14,4	8,0	1,6 - 0,4	0,8 + 0,2
	40	16,4	9,0	2,0 - 0,5	1 + 0,3
	50	18,4	10,0	2,0 - 0,5	1 + 0,3
	60	20,5	11,2	2,0 - 0,5	1 + 0,3

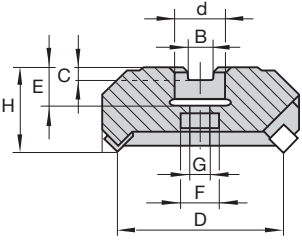
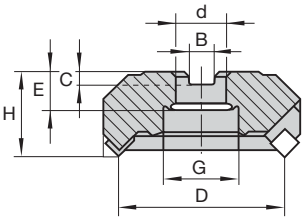
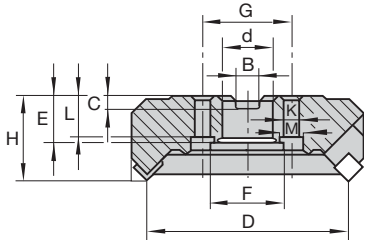
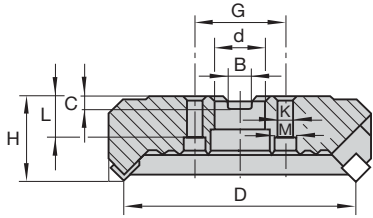
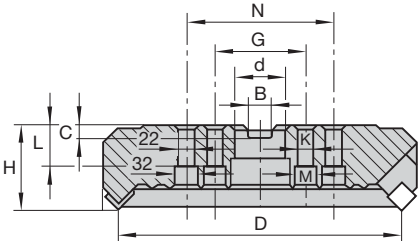
	Aufnahme Mounting	Ø D	d	H	B ^{H11}	C ^{H12} min	E min	F min	G	K	L	M/N	Fräse- anzugs- schraube Cutter draw-in bolt	
Form A 	Aufsteck- fräsdorn Shell End Mill Arbor	50	22	40	10,4	6,3	20	18	11				DIN 912	
		63											M10 x 25	
		80	27	50	12,4	7	22	20	14				DIN 912	
		100	32	50	14,4	8	25	27	18				DIN 912	
		125 ¹⁾	40	63	16,4	9	28	33	22				DIN 912	
Form B 	Aufsteck- fräsdorn Shell End Mill Arbor	80	27	50	12,4	7	22	38					DIN 6367	
		100	32	50	14,4	8	25	45					M12	
		125	40	63	16,4	9	28	56					DIN 6367	
		160 ¹⁾	50	63	18,4	10	31	68					M16	
Form C 	Aufsteck- fräsdorn und Frässpindel ISO 40 Shell End Mill Arbor and Milling spindle ISO 40	160	40	63	16,4	9 ^{+0,5}	29	56	66,7	14	28	20		
			Frässpindel ISO 50 Milling spindle ISO 50	200 und 250	60	63	25,7	14 ^{+0,5}			101,6	18	32	26
	Frässpindel ISO 50 und ISO 60 Milling spindle ISO 50 and ISO 60		315 400 500	60	80	25,7	14 ^{+0,5}			101,6	18	32	26/ 177,8	

¹⁾ nicht in DIN 8030 enthalten

¹⁾ not contained in DIN 8030

Anhang Attachment

Drallsteigungen Helix angles

nach Normzahlreihe R 20 und
genaue Drallwinkel

für Fette

- Schafffräser
 - Walzenstirnfräser
- aus Schnellarbeitsstahl

Fette-Werkzeuge

sind beschriftet mit der Drall-
steigung „H“ in [mm]

z. B. Sp. 140 $\hat{=}$ H = 140 mm

to standard number series R 20
and precise helix angles

for Fette

- Single-End End Mills
 - Shell End Mills
- in high-speed tool steel

Fette tools are marked with the
spiral lead “H” in [mm]

e. g.: Sp. 140 $\hat{=}$ H = 140 mm

ca. Drall λ	$\lambda \approx 8^\circ/10^\circ$		$\lambda \approx 25^\circ$		$\lambda \approx 30^\circ$	
	Schneiden-Ø Dia. of cut d	H (Sp ...)	H (Sp ...)	H (Sp ...)	H (Sp ...)	H (Sp ...)
2	45	7° 57'	14	24° 10'	10	32° 9'
2,5	56	7° 53'	16	26° 9'	14	29° 18'
3	63	8° 30'	20	25° 14'	16	30° 30'
3,5	71	8° 48'	25	23° 44'	20	28° 48'
4	90	7° 57'	28	24° 10'	22,4	29° 18'
4,5	90	8° 56'	31,5	24° 10'	25	29° 29'
5	90	9° 54'	35,5	23° 52'	28	29° 18'
5,5	100	9° 48'	35,5	25° 57'	31,5	28° 44'
6	112	9° 33'	40	25° 14'	35,5	27° 58'
6,5	112	10° 20'	45	24° 24'	35,5	29° 55'
7	125	9° 59'	50	23° 44'	40	28° 48'
7,5			50	25° 14'	40	30° 30'
8	140	10° 11'	56	24° 10'	45	29° 11'
8,5	160	9° 29'	56	25° 30'	45	30° 41'
9	160	10° 1'	63	24° 10'	50	29° 29'
9,5			63	25° 20'		
10	180	9° 54'	71	23° 52'	56	29° 18'
11	200	9° 48'	71	25° 57'	63	28° 45'
11,5					63	29° 49'
12	224	9° 33'	80	25° 14'	71	27° 58'
13	224	10° 20'	90	24° 25'	71	29° 54'
14	250	9° 59'	100	23° 44'	80	28° 48'
15	280	9° 33'	100	25° 14'	80	30° 30'
16	280	10° 11'	100	26° 41'	90	29° 11'
17	315	9° 37'	112	25° 30'	90	30° 41'
18	315	10° 11'	125	24° 20'	100	29° 29'
19			125	25° 32'	112	28° 3'
20	355	10° 2'	125	26° 41'	112	29° 18'
21			140	25° 13'	112	30° 30'
22	400	9° 48'	140	26° 16'	125	28° 56'
23			160	24° 18'	125	30° 2'
24	450	9° 31'	160	25° 14'	125	31° 6'
25			160	26° 9'	140	29° 18'
26	450	10° 17'	160	27° 3'	140	30° 16'
28	630	7° 57'	180	26° 3'	160	28° 48'
30	630	8° 31'	200	25° 14'	160	30° 30'
32			200	26° 41'	180	29° 11'
34			224	25° 29'	180	30° 41'
35			224	26° 9'	200	28° 48'
36	800	8° 3'	250	24° 20'	200	29° 29'
38			250	25° 32'	200	30° 50'
40			280	24° 10'	224	29° 18'
42					224	30° 30'
45			315	24° 10'	250	29° 29'
48					250	31° 6'
50	1120	7° 59'	355	23° 52'	280	29° 18'
56			400	23° 44'	315	29° 11'
60			400	25° 14'	315	30° 54'
63			450	23° 44'	355	29° 8'
75			500	25° 14'	400	30° 30'
80			560	24° 10'	450	29° 11'
90			630	24° 10'	500	29° 29'
100			710	23° 52'	500	32° 9'
110			710	25° 57'	560	31° 41'
125			900	23° 34'	710	28° 57'
130			900	24° 24'	710	29° 55'
150			1000	25° 14'	800	30° 30'
160			1120	24° 10'	900	29° 11'

H = Drallsteigung nach
Normzahlreihe
R 20 DIN 323

λ = Drallwinkel

H = Helix lead to standard
number series
R 20 DIN 323

λ = helix angle

$$\tan \lambda = \frac{d \cdot \pi}{H}$$

$\lambda \approx 32^\circ$		$\lambda \approx 40^\circ$		$\lambda \approx 45^\circ$		$\lambda \approx 50^\circ$		F. Hurth-Leitpatrone leader Kat.-Nr. Cat.-No. 1441	
H (Sp ...)	λ (genau) (exactly)	H (Sp ...)	λ (genau) (exactly)	H (Sp ...)	λ (genau) (exactly)	H (Sp ...)	λ (genau) (exactly)	H (Sp ...)	λ (genau) (exactly)
								11	29° 44'
								15,2	27° 20'
		12,5	37° 1'					15,2	31° 48'
								20,7	27° 58'
		16	38° 9'					20,7	31° 15'
								24,43	30° 3'
		20	38° 9'					24,43	32° 44'
31,5	30° 54'	22,4	40° 5'	18	46° 19'	16	49° 40'	31,2	31° 8'
								36,6	31°
40	32° 9'	31,5	38° 35'	25	45° 9'			43,39	30° 5'
						20	51° 29'	55	27° 12'
50	32° 8'	40	38° 9'	31,5	44° 55'	25	51° 29'	55	29° 44'
								68	26° 56'
63	30° 54'	45	39° 57'	40	43° 18'	31,5	50° 7'	68	29°
								75,21	28° 30'
71	31° 47'	50	41° 20'	45	44° 20'			93	25° 18'
		56	40° 5'					93	26° 52'
80	32° 9'	63	38° 35'	50	45° 9'	40	51° 29'	113,79	23° 50'
								113,79	25° 8'
90	32° 9'	71	38° 32'	56	45° 16'			113,79	26° 25'
								165,6	19° 49'
100	32° 9'	71	41° 30'	63	44° 55'	50	51° 29'	165,6	20° 46'
								165,6	21° 43'
112	31° 41'	80	40° 49'					165,6	22° 39'
								165,6	23° 34'
125	31° 6'	90	39° 57'					165,6	24° 28'
125	32° 9'	100	38° 8'			63	51° 16'	165,6	25° 22'
								165,6	26° 15'
140	32° 9'	112	38° 9'					254	19° 6'
160	30° 30'	112	40° 5'			80	49° 40'	254	20° 21'
160	32° 9'	125	38° 48'			80	51° 29'	254	21° 35'
								254	22° 48'
		140	38°						
		140	38° 56'					254	24°
								254	25° 10'
		160	38° 9'					254	26° 19'
		180	38° 9'					254	29° 6'
		200	38° 9'					254	31° 44'
		250	37°						
		250	38° 22'						
		315	36° 48'						
		315	38° 35'						
		355	38° 32'						
		400	38° 8'						
		450	37° 31'						
		500	38° 8'						
		500	39° 15'						
		630	36° 47'						
		630	38° 35'						

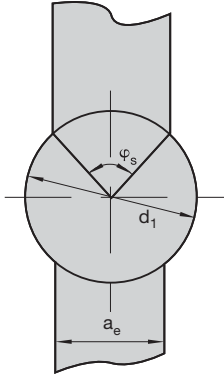
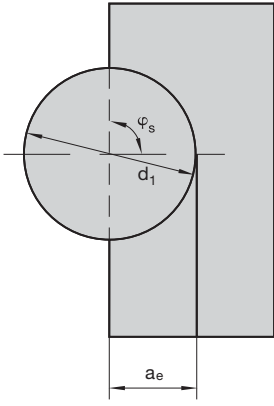
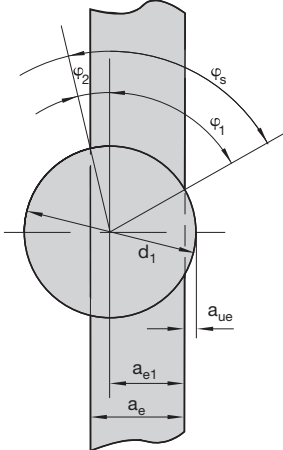
<p>Mittige Anordnung Centerline location</p>	
$\varphi_s = 2 \cdot \sin^{-1} \left(\frac{a_e}{d_1} \right)$	 <p>The diagram shows a circular end mill of diameter d_1 cutting a workpiece. The cutting is centered on the workpiece's width. The approach angle φ_s is shown as the angle between the tangent to the end mill's circumference at the cutting point and the vertical line through the center of the end mill. The cutting width is labeled a_e.</p>
<p>Kanten fräsen Edge milling</p>	
$\varphi_s = \sin^{-1} \left(\frac{ae - \frac{d_1}{2}}{\frac{d_1}{2}} \right) + 90$	 <p>The diagram shows a circular end mill of diameter d_1 cutting the edge of a workpiece. The cutting is offset from the centerline. The approach angle φ_s is shown as the angle between the tangent to the end mill's circumference at the cutting point and the vertical line through the center of the end mill. The cutting width is labeled a_e.</p>
<p>Versetzt Fräsen Adjusted milling</p>	
$\sin \varphi_1 = \frac{2 \cdot \left(\frac{d_1}{2} - a_{ue} \right)}{d_1}$ $\sin \varphi_2 = \frac{2 \cdot (a_e - a_{e1})}{d_1}$ $\sin \varphi_s = \sin \varphi_1 + \sin \varphi_2$	 <p>The diagram shows a circular end mill of diameter d_1 cutting a workpiece with an offset. The cutting is offset from the centerline by a_{ue}. The cutting width is a_e, and the distance from the centerline to the start of the cut is a_{e1}. The approach angle φ_s is shown as the angle between the tangent to the end mill's circumference at the cutting point and the vertical line through the center of the end mill. The diagram also shows intermediate angles φ_1 and φ_2.</p>

Anhang Attachment

Maße und Einheiten Dimensions and units	Anwendungs-Formeln Application formulas									
<p>a_p = Spanungstiefe in mm Depths of cut in mm</p> <p>a_e = Spanungsbreite in mm Width of cut in mm</p> <p>l = Bearbeitete Länge in mm Machined length in mm</p> <p>h_m = Mittenspanndicke in mm Mean chip thickness</p> <p>v_c = Schnittgeschwindigkeit in m/mm Cutting speed in m/mm</p> <p>f_z = Vorschub pro Zahn in mm Feed per tooth in mm</p> <p>d_1 = Äußerer Werkzeugdurchmesser Outside tool diameter</p> <p>d_e = Effektiver Durchmesser, Schnittkreisdurchmesser in mm Effective diameter with different inserts and at specified cut depth in mm</p> <p>d = Durchmesser der Platte in mm Insert diameter in mm</p> <p>z = Anzahl der Schneiden am Werkzeug Number of tool cutting edges</p> <p>κ = Einstellwinkel Lead angle</p> <p>φ_s = Eingriffswinkel Approach angle</p>	<p>Umdrehungen pro Minute n [U/min] Revolutions per minute n [rpm]</p> $n = \frac{v_c \cdot 1000}{\pi \cdot d_e}$	<p>Mittlere Spandicke h_m [mm] Mean chip thickness h_m mm]</p> $h_m = f_z \cdot \sqrt{\frac{a_e}{d_e}}$								
	<p>Vorschubgeschwindigkeit v_f [mm/min] Feed rate v_f [mm/min]</p> $v_f = f_z \cdot n \cdot z$	<p>gültig nur bis valid only up to $\frac{a_e}{d_e} < 0,3$ bzw. 30% oder $\varphi = 60^\circ$ sonst otherwise $h_m = \frac{360 \cdot f_z \cdot a_e \cdot \sin(\kappa)}{\pi \cdot d_e \cdot \varphi_s}$</p>								
	<p>Vorschub pro Umdrehung f [mm/U] Feed per revolution f [mm/rev.]</p> $f = \frac{v_f}{n}$	<p>Zerspanungsvolumen Q [cm³/min] Chip removal rate Q [cm³/min]</p> $Q = \frac{a_p \cdot a_e \cdot v_f}{1000}$								
	<p>Vorschub pro Zahn f_z [mm/z] Feed per tooth f_z [mm/tooth]</p> $f_z = h_m \cdot \sqrt{\frac{d_e}{a_e}}$ <p>gültig nur bis valid only up to $\frac{a_e}{d_e} < 0,3$ bzw. 30% oder $\varphi = 60^\circ$</p>	<p>Effektiver Schnittkreisdurchmesser [mm] Effective diameter of cutting</p> $d_e = d_1 - d + 2 \sqrt{a_p (d - a_p)}$								
	<table border="1"> <thead> <tr> <th>Einstellwinkel κ Plunge angle</th> <th>Vorschub pro Zahn f_z Feed per tooth</th> </tr> </thead> <tbody> <tr> <td>90°</td> <td>f_z</td> </tr> <tr> <td>45°</td> <td>$f_z \cdot 1,414$</td> </tr> <tr> <td>30°</td> <td>$f_z \cdot 2$</td> </tr> </tbody> </table> <p>sonst otherwise $f_z = \frac{h_m \cdot \pi \cdot d_e \cdot \varphi_s}{360 \cdot a_e \cdot \sin(\kappa)}$</p>	Einstellwinkel κ Plunge angle	Vorschub pro Zahn f_z Feed per tooth	90°	f_z	45°	$f_z \cdot 1,414$	30°	$f_z \cdot 2$	
	Einstellwinkel κ Plunge angle	Vorschub pro Zahn f_z Feed per tooth								
	90°	f_z								
	45°	$f_z \cdot 1,414$								
	30°	$f_z \cdot 2$								

Umwertungstabelle für Härtewerte und Zugfestigkeit (vgl. DIN 50150 (12.76))
Conversion table for hardness values and tensile strength (cf. DIN 50150 (12.76))

Zugfestigkeit Tensile strength R_m N/mm ²	Vickershärte Vickers hardness HV	Brinellhärte Brinell hardness HB	Rockwellhärte Rockwell hardness HRc	Zugfestigkeit Vickershärte Brinellhärte Errechnet aus: HB = 0,95 x HV Rockwellhärte C Tensile strength Vickers hardness Brinell hardness Errechnet aus: HB = 0,95 x HV Rockwell hardness	R_m HV HB HRc	N/mm ² Diamantpyramide 136° Prüfkraft F > 98N 0,102 x F/D ² = 30 N/mm ² F = Prüfkraft in N D = Kugeldurchmesser in mm Diamantkegel 120° Gesamtprüfkraft 1471N N/mm ² Diamond pyramide 136° Test force F>98N 0,102 x F/D ² = 30 N/mm ² F = test force in N D = ball diameter in mm Diamond taper 120° Total test force 1471N
255	80	76				
285	90	85,5				
320	100	95				
350	110	105				
385	120	114				
415	130	124				
450	140	133				
480	150	143				
510	160	152				
545	170	162				
575	180	171				
610	190	181				
640	200	190				
675	210	199				
705	220	209				
740	230	219				
770	240	228	20,3			
800	250	238	22,2			
835	260	247	24			
865	270	257	25,6			
900	280	266	27,1			
930	290	276	28,5			
965	300	285	29,8			
1030	320	304	32,2			
1095	340	323	34,4			
1155	360	342	36,6			
1220	380	361	38,8			
1290	400	380	40,8			
1350	420	399	42,7			
1420	440	418	44,5			
1485	460	437	46,1			
1555	480	456	47,7			
1595	490	466	48,4			
1665	510	485	49,8			
1740	530	507	51,1			
1810	550	523	52,3			
1880	570	542	53,6			
1955	590	561	54,7			
2030	610	580	55,7			
2105	630	599	56,8			
2180	650	618	57,8			
	670	626	58,8			
	690		59,7			
	720		61			
	760		62,5			
	800		64			
	840		65,3			
	880		66,4			
	920		67,5			
	940		68			

Anhang Attachment

Norm-Bezeichnungen von Werkzeugen nach DIN Standard tool designations to DIN

Innerhalb der einzelnen Werkzeugnormen ist jeweils auch die Bezeichnung des entsprechenden Werkzeuges systematisiert. Die Norm-Bezeichnungen werden alltäglich zwar nur selten benutzt, wir führen interessehalber aber doch hier einige typische Beispiele an.

Within the individual tool standards, the designation of the tool in question, has been standardised. Although the standard designations are rarely in everyday use, a few typical examples are given below for information.

Fräser DIN 844 Milling Cutter DIN 844	A	25	K	N	HSS
Schaftfräser mit Zylinderschaft End Mill with straight shank					
Form Form					
Schneidendurchmesser d_1 Diameter of cut d_1					
Kurze Ausführung Short version					
Werkzeug-Anwendungsgruppe Tool application group					
Legierungsgruppe des Schnellarbeitsstahles Alloy group of the high-speed steel					

Fräser DIN 1880 Milling Cutter DIN 1880	63	N	HSS
Walzenstirnfräser Shell End Mill			
Durchmesser d_1 Diameter d_1			
Werkzeug-Anwendungsgruppe Tool application group			
Legierungsgruppe des Schnellarbeitsstahles Alloy group of the high-speed steel			

Fräser DIN 844 Milling Cutter DIN 844	A	25	L	LL	M	NR	h6	R4,5	Z6	HSS
Schaftfräser mit Zylinderschaft End Mill with straight shank										
Form Form										
Schneidendurchmesser d_1 Diameter of cut d_1										
Lange Ausführung Long version										
Linksschneidend, mit Linksdrall LH cut, with LH helix										
Über Mitte schneidend Cutting over centre										
Werkzeug-Anwendungsgruppe Tool application group										
Toleranzfeld des Zylinderschaftes Tolerance range of the straight shank										
Eckenradius Corner radius										
Anzahl der Schneiden Number of blades										
Legierungsgruppe des Schnellarbeitsstahles Alloy group of the high-speed steel										

Fräser DIN 1880 Milling Cutter DIN 1880	63	LL	NR	Z10	HSS
Walzenstirnfräser Shell End Mill					
Durchmesser d_1 Diameter d_1					
Linksschneidend, mit Linksdrall LH cut, with LH helix					
Werkzeug-Anwendungsgruppe Tool application group					
Anzahl der Schneiden Number of blades					
Legierungsgruppe des Schnellarbeitsstahles Alloy group of the high-speed steel					

Fräser DIN 885 Milling Cutter DIN 885	A	50 x 10	N	HSS
Scheibenfräser Side Milling Cutter				
Form Form				
Durchmesser d_1 Diameter d_1				
Breite b Width b				
Werkzeug-Anwendungsgruppe Tool application group				
Legierungsgruppe des Schnellarbeitsstahles Alloy group of the high-speed steel				

Abhilfe und Lösungen Removal and solutions	Problem Problem										
	Freiflächen-Verschleiß Flank wear	Kolkverschleiß Crater wear	Plattenabsplitterungen Flaking	Kammerisse Thermal cracks	Ermüdungsrisse Fatigue cracks	Plastische Verformung Plastic deformation	Kerb-Verschleiß Notch wear	Aufbauschneidenbildung Built-up edge	Schneidkantenbruch Cutting edge failure	Vibrationen Vibration	Schlechte Oberflächenqualität Poor surface quality
Verschleißfestere HM-Sorte Carbide grade with higher wear resistance	●	●				●	●				●
Zähere HM-Sorte Tougher carbide grade			●	●	●				●		
Schnittgeschwindigkeit erhöhen Increase cutting speed			●					●			
Schnittgeschwindigkeit verringern Reduce cutting speed	●	●		●		●					
Vorschub pro Zahn erhöhen Increase feed per tooth	●							●		●	
Vorschub pro Zahn verringern Reduce feed			●	●	●	●	●		●		●
Fräserpositionierung ändern Change cutter positioning					●					●	
Kleinerer Fräserdurchmesser Smaller cutter diameter				●							
Stabilität verbessern Improve rigidity			●					●	●		
Verwendung einer beschichteten Sorte Use coated inserts	●	●						●			
Kühlmittel verwenden Use coolant				●		●					



LMT Deutschland GmbH
Heidenheimer Straße 108
D-73447 Oberkochen
Tel. +49 (0) 73 64/95 79-10
Fax +49 (0) 73 64/95 79-30
E-mail: lmtd@LMT-tools.com
Internet: www.LMT-tools.de
www.LMT-tools.com

BELIN

Belin Yvon S.A.
F-01590 Lavancia, Frankreich
Tel. +33 (0) 4 74 75 89 89
Fax +33 (0) 4 74 75 89 90
E-mail: belin@belin-y.com
Internet: www.belin-y.com

BILZ

Bilz Werkzeugfabrik GmbH & Co. KG
Vogelsangstraße 8
D-73760 Ostfildern, Deutschland
Tel. +49 (0) 711 3 48 01-0
Fax +49 (0) 711 3 48 12 56
E-mail: info@bilz.de
Internet: www.bilz.de

BOEHLERIT

Boehlerit GmbH & Co. KG
Werk VI-Straße
Deuchendorf
A-8605 Kapfenberg, Österreich
Tel. +43 (0) 38 62 300-0
Fax +43 (0) 38 62 300-793
E-mail: blk@boehlerit.com
Internet: www.boehlerit.com

FETTE

Fette GmbH
Grabauer Str. 24
D-21493 Schwarzenbek, Deutschland
Tel. +49 (0) 41 51 12-0
Fax +49 (0) 41 51 37 97
E-mail: tools@fette.com
Internet: www.fette.com

KIENINGER

Kieninger GmbH
An den Stegmatten 7
D-77933 Lahr-Mietersheim, Deutschland
Tel. +49 (0) 7821 943-0
Fax +49 (0) 7821 943-213
E-mail: info@kieninger.de
Internet: www.kieninger.de

ONSRUD

Onsrud Cutter LP
800 Liberty Drive
Libertyville, Illinois 60048, USA
Tel. +1 (847) 362-1560
Fax +1 (847) 362-5028
E-mail: info@onsrud.com
Internet: www.onsrud.com